

# THE FEDERAL RESERVE SYSTEM AFTER FIFTY YEARS

---

---

## HEARINGS BEFORE THE SUBCOMMITTEE ON DOMESTIC FINANCE OF THE COMMITTEE ON BANKING AND CURRENCY HOUSE OF REPRESENTATIVES EIGHTY-EIGHTH CONGRESS

SECOND SESSION

ON

### H.R. 3783

A BILL TO PROVIDE FOR THE RETIREMENT OF FEDERAL RESERVE  
BANK STOCK, AND FOR OTHER PURPOSES

### H.R. 9631

A BILL TO INCREASE TO 12 THE NUMBER OF MEMBERS OF THE  
FEDERAL RESERVE BOARD, AND FOR OTHER PURPOSES

### H.R. 9685

A BILL TO AMEND THE FEDERAL RESERVE ACT TO PROVIDE THAT  
INTEREST RECEIVED BY FEDERAL RESERVE BANKS ON OBLIGA-  
TIONS OF THE UNITED STATES SHALL BE COVERED INTO THE  
TREASURY AS MISCELLANEOUS RECEIPTS, TO AUTHORIZE APPRO-  
PRIATIONS FOR THE EXPENSES OF THE FEDERAL RESERVE BANKS  
AND THE BOARD OF GOVERNORS OF THE FEDERAL RESERVE  
SYSTEM, AND FOR OTHER PURPOSES

### H.R. 9686

A BILL TO REQUIRE THE PAYMENT OF INTEREST ON CERTAIN  
FUNDS OF THE UNITED STATES HELD ON DEPOSIT IN COMMERCIAL  
BANKS, TO PROVIDE FOR REIMBURSEMENT OF COMMERCIAL BANKS  
FOR SERVICES PERFORMED FOR THE UNITED STATES, AND FOR  
OTHER PURPOSES

### H.R. 9687

A BILL TO AMEND THE FEDERAL RESERVE ACT AND THE FEDERAL  
DEPOSIT INSURANCE ACT BY ELIMINATING THE PROHIBITION  
AGAINST THE PAYMENT OF INTEREST ON DEMAND DEPOSITS

### H.R. 9749

A BILL TO AMEND THE FEDERAL RESERVE ACT TO PROVIDE FOR  
FEDERAL RESERVE SUPPORT OF GOVERNMENT BONDS WHEN  
MARKET YIELDS EQUAL OR EXCEED  $4\frac{1}{4}$  PERCENT

---

## VOLUME 2

---

FEBRUARY 11, 25, 26, 27; MARCH 3, 4, 5, 9, 10, 11, 12 AND 25, 1964

---

Printed for the use of the Committee on Banking and Currency

U.S. GOVERNMENT PRINTING OFFICE

WASHINGTON : 1964

28-680

## COMMITTEE ON BANKING AND CURRENCY

WRIGHT PATMAN, Texas, *Chairman*

ALBERT RAINS, Alabama	CLARENCE E. KILBURN, New York
ABRAHAM J. MULTER, New York	WILLIAM B. WIDNALL, New Jersey
WILLIAM A. BARRETT, Pennsylvania	EUGENE SILER, Kentucky
LEONOR K. SULLIVAN, Missouri	PAUL A. FINO, New York
HENRY S. REUSS, Wisconsin	FLORENCE P. DWYER, New Jersey
THOMAS L. ASHLEY, Ohio	SEYMOUR HALPERN, New York
CHARLES A. VANIK, Ohio	JAMES HARVEY, Michigan
WILLIAM S. MOORHEAD, Pennsylvania	OLIVER P. BOLTON, Ohio
ROBERT G. STEPHENS, Jr., Georgia	W. E. (BILL) BROCK, Tennessee
FERNAND J. ST GERMAIN, Rhode Island	ROBERT TAFT, Jr., Ohio
HENRY B. GONZALEZ, Texas	JOSEPH M. McDADE, Pennsylvania
CLAUDE PEPPER, Florida	SHERMAN P. LLOYD, Utah
JOSEPH G. MINISH, New Jersey	BURT L. TALCOTT, California
CHARLES L. WELTNER, Georgia	DEL CLAWSON, California
RICHARD T. HANNA, California	
BERNARD F. GRABOWSKI, Connecticut	
CHARLES H. WILSON, California	
COMPTON I. WHITE, Jr., Idaho	

JOHN R. STARK, *Clerk and Staff Director*

JOHN E. BARRIERE, *Professional Staff Member*

ALVIN LEE MORSE, *Counsel*

ORMAN S. FINK, *Minority Staff Member*

---

## SUBCOMMITTEE ON DOMESTIC FINANCE

WRIGHT PATMAN, Texas, *Chairman*

HENRY S. REUSS, Wisconsin	WILLIAM B. WIDNALL, New Jersey
CHARLES A. VANIK, Ohio	JAMES HARVEY, Michigan
CLAUDE PEPPER, Florida	OLIVER P. BOLTON, Ohio
JOSEPH G. MINISH, New Jersey	W. E. (BILL) BROCK, Tennessee
CHARLES L. WELTNER, Georgia	ROBERT TAFT, Jr., Ohio
RICHARD T. HANNA, California	
CHARLES H. WILSON, California	

ROBERT E. WEINTEAUB, *Senior Economist*

ROBERT A. SCHREMP, *Investigator*

HARVEY W. GEIST, *Investigator*

STEPHEN D. KENNEDY, *Research Assistant*

# CONTENTS

Statement of—

	Page
Bach, Prof. G. L., Stanford University and Carnegie Institute of Technology.....	1387
Barger, Prof. Harold, chairman, Department of Economics, Columbia University.....	1353
Brownlee, Prof. O. H., University of Minnesota.....	1061
Brunner, Prof. Karl, University of California, Los Angeles.....	1047, 1050
Daane, Hon. J. Dewey, member of the Board of Governors, Federal Reserve System.....	1191
Dillon, Hon. Douglas, Secretary of the Treasury.....	1230, 1236
Friedman, Prof. Milton, University of Chicago, Chicago, Ill.....	1133
Goldfinger, Nathaniel, director, Department of Research, American Federation of Labor & Congress of Industrial Organizations.....	1471
Gordon, Prof. H. Scott, Carleton University, Ottawa, Canada.....	943
Gurley, Prof. John, Stanford University.....	1309
Johnson, Prof. Dudley W., University of Washington.....	1433
Johnson, Prof. Harry G., University of Chicago, Chicago, Ill.....	970
Lerner, Prof. Abba P., Michigan State University.....	1398
Meltzer, Prof. Allan H., Carnegie Institute of Technology, Pittsburgh, Pa.....	926, 938
Mitchell, Hon. George W., member of the Board of Governors, Federal Reserve System.....	1179
Robertson, Prof. Ross M., business economics and public policy, Graduate School of Business, Indiana University.....	1357
Samuelson, Prof. Paul A., Massachusetts Institute of Technology.....	1114
Shapiro, Prof. Eli, Harvard University, Cambridge, Mass.....	1098
Strotz, Prof. Robert H., Department of Economics, Northwestern University.....	1451
Villard, Prof. Henry H., College of the City of New York.....	1020
Warburton, Dr. Clark, Federal Deposit Insurance Corporation.....	1314

Additional statements and information submitted to the subcommittee by—

Bach, Prof. G. L., Stanford University: Federal Reserve organization and policymaking.....	1393
Brock, Hon. W. E.: "Johnson and Martin—Varied Forces Could Propel Them Toward a Conflict," article from the Wall Street Journal, March 9, 1964.....	1426
Brunner, Prof. Karl, University of California:	
Chart 1. Percentage change of money supply between corresponding months of adjacent years.....	1059
Chart 2. $\Delta B + \Delta L$ corresponding months (adjacent years).....	1060
Comments on Governor Mitchell's testimony.....	1223
Daane, Gov. J. Dewey: Supplemental statement.....	1213
Dillon, Hon. Douglas, Secretary of the Treasury:	
Information concerning central banking policies.....	1246
Proposal regarding Federal Reserve action to prevent market yields on Government securities from rising above $4\frac{1}{4}$ percent.....	1251
Comparison of usable space by 12 Federal Reserve banks and space in U.S. Government buildings in the Federal Triangle in Washington.....	1268
Special advantage of the tax and loan account system.....	1269
Letter with answers to questions submitted to the Secretary by the chairman, Mr. Patman, dated March 17, 1964.....	1273
Statement of the public debt, February 29, 1964 (table).....	1274
Tax policy.....	1293

## Additional statements and information, etc.—Continued

Friedman, Prof. Milton, University of Chicago:	
Chart I. Comparison of changes in money and production, 1957-63.....	Page 1136
Comments on testimony of Gov. George W. Mitchell and Gov. J. Dewey Daane.....	1220
Should there be an independent monetary authority?.....	1165
Goldfinger, Nathaniel, director, AFL-CIO:	
Statement of executive council on the balance of payments.....	1484
"City School Board Borrows \$1.25 Million in Investment Scheme To Gain Interest," article from the Gazette and Daily, York, Pa., dated March 20, 1964.....	1496
Gurley, Prof. John, Stanford University: Tables 1 and 2. Money supply.....	1313
Johnson, Prof. Dudley W., University of Washington:	
Table I. The money supply, 1962-63.....	1438
Table II. Changes in the holdings of Government securities.....	1439
Table III. Excess reserves for all member banks, 1960-63.....	1440
Table IV. Behavior of "free reserves," 1960-63.....	1440
Johnson, Prof. Harry G., University of Chicago: Alternative guiding principles for the use of monetary policy, essays in international finance.....	975
Kilburn, Hon. Clarence E.: Letters to Hon. Wright Patman, chairman, dated March 5 and 13, 1964.....	1510
Meltzer, Prof. Allan H., Carnegie Institute of Technology:	
Chart I. National income and predicted income.....	929
Chart II. Average monthly changes in money and bank credit in postwar cycles.....	931
Chart III. Annual changes in currency between corresponding months.....	933
Charts IIIa, IIIb, IIIc.....	934-936
Mitchell, Hon. George W., Board of Governors, Federal Reserve System:	
Percent change over corresponding month of preceding year, 1949-63.....	1187
Selected earnings data for member banks, by class of bank, 1954-63, tables I-IX.....	1188-1191
Supplemental statement.....	1213
Patman, Hon. Wright, chairman, House Banking and Currency Committee:	
Letter from Wm. McC. Martin, Jr., Board of Governors of the Federal Reserve System, to Hon. Paul H. Douglas, chairman, Joint Economic Committee, dated November 5, 1963, with attachments.....	1381
Letter to Hon. Clarence E. Kilburn, dated March 14, 1964.....	1511
Wide variances in top salaries received by Federal Reserve bank employees and those of other U.S. Government employees.....	1093
Annual salaries of the principal Federal officials.....	1095
Yields on long-term Government bonds, by months, 1919 to present.....	1416
Robertson, Prof. Ross M., Indiana University:	
"The Mysterious World of the Fed".....	1519
"Credit Policy at the Discount Window".....	1525
Samuelson, Prof. Paul A., Massachusetts Institute of Technology:	
"How To Be a Central Banker," article from the Washington Post, November 24, 1963.....	1124
"Money Machinations," article from the Washington Post, August 25, 1963.....	1126
Warburton, Dr. Clark, Federal Deposit Insurance Corporation:	
Guidelines for Federal Reserve operations.....	1320
Capital stock of Federal Reserve banks.....	1328
Extension of reserve requirements to commercial banks not now members of the Federal Reserve System.....	1332
Proposals for change in the membership and terms of office of the Board of Governors of the Federal Reserve System and in the relation of the System to other financial agencies of the Federal Government.....	1333

## APPENDIX

	<b>Page</b>
Supplemental statement of Gov. George W. Mitchell and Gov. J. Dewey Daane.....	1213, 1515
Comment by Gov. George W. Mitchell on Prof. Milton Friedman's comments.....	1517
"The Mysterious World of the Fed," by D. C. Hastings and R. M. Robert- son.....	1519
"Credit Policy at the Discount Window," by C. R. Whittlesey.....	1525

# THE FEDERAL RESERVE SYSTEM AFTER 50 YEARS

TUESDAY, FEBRUARY 11, 1964

HOUSE OF REPRESENTATIVES,  
SUBCOMMITTEE ON DOMESTIC FINANCE OF THE  
COMMITTEE ON BANKING AND CURRENCY,  
*Washington, D.C.*

The subcommittee met, pursuant to recess, at 10 a.m., in room 3101, Longworth House Office Building, Hon. Wright Patman (chairman) presiding.

Present: Representatives Patman, Reuss, Kilburn, and Widnall.

The CHAIRMAN. The committee will please come to order.

At these hearings on the first 50 years of the Federal Reserve System, officials of the System have testified, as one, that the Federal Reserve has done a fine job with the monetary powers Congress has entrusted to it, and is in need of little, if any, reform.

I have doubts about this. As Al Smith said, "Let's look at the record." Almost everyone will agree the Federal Reserve's record in the 1929-33 depression was bad. This is not a partisan opinion. President Hoover wrote in his memoirs (page 212) that the Federal Reserve "was indeed a weak reed for a nation to lean on in time of trouble."

Since Hoover's time we haven't had a great depression. But we have had five recessions and two inflations in the 30 years since 1933, and this is not a record anybody ought to brag about.

Of course, the Federal Reserve's officials will tell you these episodes weren't its fault, but reflect the failure of other policies. This is at best a half-truth. Recognizing that other policies, especially fiscal policy, influenced past economic trends and turns in no way whatever absolves the Federal Reserve from responsibility for these trends and turns.

Let's look at the five recessions and two inflations we've had since 1933. Between the summer of 1936 and the spring of 1937 the Federal Reserve doubled bank reserve requirements. The price we paid for this was the sharp 1937-38 business and employment decline.

Inflation was unavoidable during the Second World War and immediately thereafter. But the Federal Reserve was not completely blameless in this episode. In 1942 reserve requirements at central city banks were reduced from 26 to 20 percent. It was 1948 before this inflationary action was reversed and reserve requirements at central city banks increased back to 26 percent.

During the 1948-49 recession the Federal Reserve reduced its holdings of Government securities by \$5 billion. These sales decreased bank lending and investing power, and thereby aggravated the 1948-49 recession.

During the sharp inflation that followed the invasion of South Korea, the Federal Reserve did nothing until January–February 1951 when reserve requirements on demand deposits were raised by 2 percent and on time deposits by 1 percent. The Korean war inflation slowed down almost to zero immediately.

From the spring of 1951 until now our great and essentially healthy and venturesome free enterprise economy has three times been throttled by the Open Market Committee of the Federal Reserve System. The Open Market Committee's decisions affect the money supply and interest rates. I will let the facts speak for themselves. The recession of 1953–54 began in July 1953. Interest rates on Government securities began to rise early in 1953. The growth of the money supply fell steadily beginning in January 1953, and by July was at an annual rate of less than 1 percent.

The next recession began in July 1957 and lasted until April 1958. Interest rates started to rise in the middle of 1956. The growth of the money supply fell below 2 percent during 1956 and by the spring of 1957 the money stock was actually decreasing. It continued to decrease until the beginning of 1958, long after the recession began.

The most recent recession began in May 1960 and lasted until February 1961. Once again we find interest rates rising and the growth of the money supply falling just before the downturn. The money supply fell from \$142.8 billion at the end of September 1959 to \$139.4 billion in June 1960.

Beginning today we are going to hear from some outstanding economists who are expert in monetary matters. I am sure we will all benefit from their discussions and answers to our questions on the Federal Reserve's past and present policies, and on how much independence it needs.

Today we have Prof. Allan Meltzer, and I believe I will ask you to put your statement in the record at this point and then summarize it, if you please.

Just bring out the main points and then, after you get through, we have with us Prof. H. Scott Gordon, of Carleton University, Ottawa, Canada, and his statement is not long, so it will be all right for him to read it, and then we will ask both of you gentlemen questions after you have concluded.

(Mr. Meltzer's statement referred to follows:)

STATEMENT OF ALLAN H. MELTZER, GRADUATE SCHOOL OF INDUSTRIAL  
ADMINISTRATION, CARNEGIE INSTITUTE OF TECHNOLOGY

SOME SUGGESTED CHANGES IN MONETARY ARRANGEMENTS\*

Two separable questions underlie the changes that this committee is considering. Both have to do with a primary concern in the monetary area; viz, the effectiveness of arrangements connecting monetary

\*A statement prepared for the hearings before the Committee on Banking and Currency, U.S. House of Representatives, Feb. 11, 1964. The analysis supporting the following statement has been conducted jointly by the author and Karl Brunner, of UCLA, in a series of papers and in a report prepared for this committee entitled "An Analysis of Federal Reserve Monetary Policymaking."

policy with the behavior of prices and output in the economy. One question involves the effectiveness of the Federal Reserve as an agency for carrying out the congressional mandate imposed by the Federal Reserve Act, the Employment Act, and other legislative expressions of public policy. This question is summarized by asking: Does the Federal Reserve have effective operating control of the money supply? The other question involves the connection between the money supply and the pace of economic activity. It asks: Do changes in the stock of money alter the level of income in the short run? Unless both of these questions can be answered affirmatively, we must either look for new arrangements or abandon the hope of improving our policies.

A considerable amount of evidence is available that helps to provide answers to both questions. The evidence comes from the United States and a variety of countries and from detailed study of Federal Reserve policymaking procedures. It suggests that the relation of the money supply to economic activity is sufficiently close that we can count on a reasonably reliable and predictable effect, provided that we have adequate control of the supply of money. Unfortunately, our study of Federal Reserve policymaking uncovered very little evidence that their understanding of the monetary process or their procedures for controlling it are at all adequate for the important task delegated by the Congress.

Again, there are two issues. The first concerns the adequacy of Federal Reserve procedures for deciding on the present and near term future outlook for the economy. Here we find that the record since 1951 has been excellent. The Federal Reserve has made correct and timely judgments at turning points. They have shown judicious prescience. In the current state of knowledge, there is little reason to expect a performance superior to the record achieved.

But there is the second part of the problem. This involves knowing what to do when turning points are predicted or are judged to have occurred. An adequate understanding of the money supply process, of the factors governing the response of the stock of money to Federal Reserve policy, is required for this purpose. Our detailed study of the Federal Reserve's procedures reveals that their knowledge of the monetary process is woefully inadequate, unverified, and incapable of bearing the heavy burden that is placed upon it. After 50 years, the Federal Reserve has little verified knowledge to form the basis for its policy actions. Equally important, the dominant views expressed by Federal Reserve officials are founded on notions that were responsible for major errors in 1929-33, 1936-37, and at other crucial points.

I would like to expand briefly on some of the points raised before suggesting some changes in policymaking arrangements. A more detailed discussion of many of the questions involved and a more adequate analysis of the weaknesses in the Federal Reserve conception is contained in the study that we are preparing at the request of this committee.<sup>1</sup>

<sup>1</sup> Karl Brunner and Allan H. Meltzer, "An Analysis of Federal Reserve Monetary Policy-making," House Committee on Banking and Currency, Washington, D.C., 1964.



## THE RELATION OF MONEY TO INCOME

Monetary policy is predicated on the notion that there is a reliable connection between the quantity of money and money income. If there is no connection between the two; monetary policy is useless as a device for carrying out the goals of maximum employment and purchasing power embodied in the Employment Act. Evidence from a large number of countries and many different time periods suggests that money and money national income are closely associated. The observed association can be explained in a number of ways; that is, by means of alternative theories.

One explanation emphasizes the casual importance of money in generating greater utilization of our human and physical resources. Predictions of annual values of money national income from the factors influencing the demand for and supply of money have been able to indicate all of the turning points in economic activity since 1925.

For the years 1951-58, annual values of national income have been predicted with an error of 2.5 percent. This is but one piece of evidence supporting the contention that monetary policy plays an important role in determining the level of income.<sup>2</sup>

Some additional evidence on this point is presented in chart I. We have used the factors determining the demand for and supply of money to forecast quarterly values of income from the fourth quarter of 1954 through 1959. The results of some preliminary efforts shown in the chart, once again suggests the importance of monetary factors. Our forecasts have an average error of 1.5 percent for the period. Moreover, the forecasts are reasonably reliable at turning points in economic activity. While the stock of money (currency and demand deposits) is not the only factor that is used in making these predictions, our analysis suggests that periods of decline or little growth in the money supply are followed by periods of slow growth or decline in economic activity.

As I indicated in my testimony before the Joint Economic Committee last year,<sup>3</sup> the very slow rate of growth in the money supply from 1959-62 was a factor of paramount importance in the slow rate of utilization of resources and the high rate of unemployment in those years. I urged then that the rate of monetary expansion be increased and argued that if this were done, we could reach higher levels of economic activity while reducing our gold outflow. The record for 1963 amply supports these contentions. The average rate of growth of the money supply (currency and demand deposits) was above 4 percent for the first time in many years. Economic activity expanded while the gold outflow slowed.

These facts are indicated to emphasize the importance of the issues that this committee is considering and the great power that has been entrusted to the Federal Reserve Board. Monetary policy is not a matter of "pushing on strings" as the Board and others have so often suggested. It is a powerful force in our economy, as you are well

<sup>2</sup> Karl Brunner and Allan H. Meltzer, "Predicting Velocity: Implications for Theory and Policy," *Journal of Finance*, May 1963.

<sup>3</sup> "Monetary Policy for 1963," hearings before the Joint Economic Committee, Feb. 6, 1963. See also the similar statement of Beryl Sprinkel at this committee's hearings on the balance of payments, July 1963.

CHART I

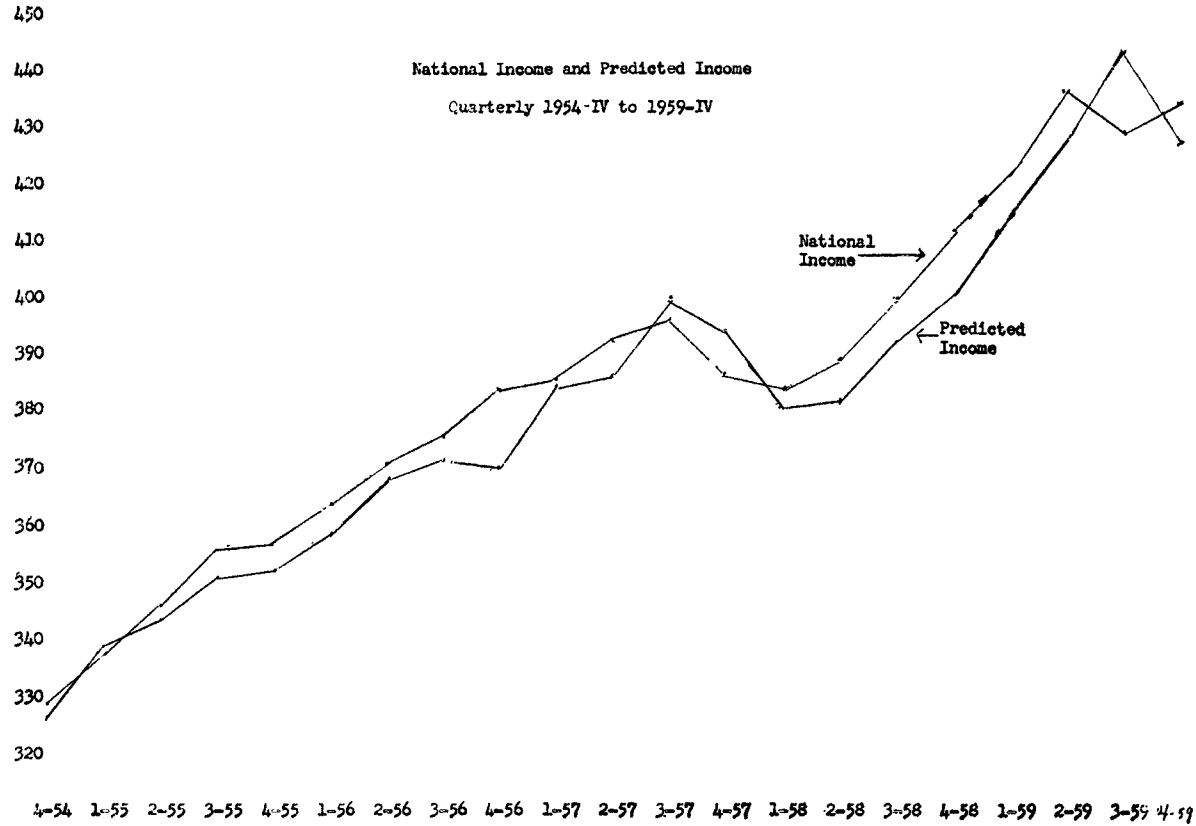

aware. Let us consider, therefore, how the Federal Reserve has used the power delegated to it.

#### THE FEDERAL RESERVE'S UNDERSTANDING OF THE MONETARY PROCESS

I have already indicated that the Federal Reserve has an excellent record in judging turning points in the period since 1951. But correct judgment at turning points is not enough. Appropriate action must be taken, or the advantage of making correct judgments about the state of the economy is of little value.

Two issues are chosen from the many available to illustrate the importance of careful analysis and the absence of a validated, systematic understanding of monetary processes by the Federal Reserve. One concerns the perennial confusion between money and "credit" that is a prominent feature of Federal Reserve discussions. The other suggests the importance of some elements that play a dominant role in the monetary process and have no role at all in Federal Reserve discussions. The cyclical behavior of the public's demand for currency is the issue chosen for this purpose.

A major failure of the Federal Reserve is the failure to understand the importance of money in the economy. When asked by the Joint Economic Committee to distinguish between monetary expansion and credit expansion, the Board submitted the following written reply:

No difference was meant by the two terms "bank credit expansion" \* \* \* and "monetary expansion" \* \* \*

\* \* \* "bank credit expansion" and "monetary expansion" are essentially two sides of the same coin."<sup>4</sup>

Chart II reveals that this statement is totally incorrect. The rate of monetary expansion in the postwar period has been slower during periods of economic expansion than during periods of recession. Federal Reserve policy has been perverse. They have permitted larger rates of growth in the money supply during periods of expansion than during periods of contraction. This is the direct opposite of a policy designed to expand economic activity during recession and to control inflation.

I do not wish to suggest that the Federal Reserve desires to add to our unemployment or to promote inflation. When we look at this stock of "bank credit" for the same periods, we note "credit expansion" has behaved in a countercyclical way. The rate of "credit expansion" has been greater during periods when unemployment and recession were our national concerns. And the rate of "credit expansion" slowed during periods of expanding economic activity.

Thus, if monetary and credit expansion were "two sides of the same coin" and both behaved in a countercyclical way, our confidence in the Federal Reserve's operations would be greatly increased. But the two are not the same. Therefore, we must conclude that Federal Reserve policy with respect to the money stock has been perverse on the average in the postwar years. They have not understood the basic process that they have been entrusted to control.

<sup>4</sup> Review of the Annual Report of the Board of Governors of the Federal Reserve System for the Year 1960, hearings before the Joint Economic Committee (Washington, GPO, 1961), p. 147.

CHART II  
 AVERAGE MONTHLY CHANGES IN MONEY  
 AND BANK CREDIT IN POSTWAR CYCLES

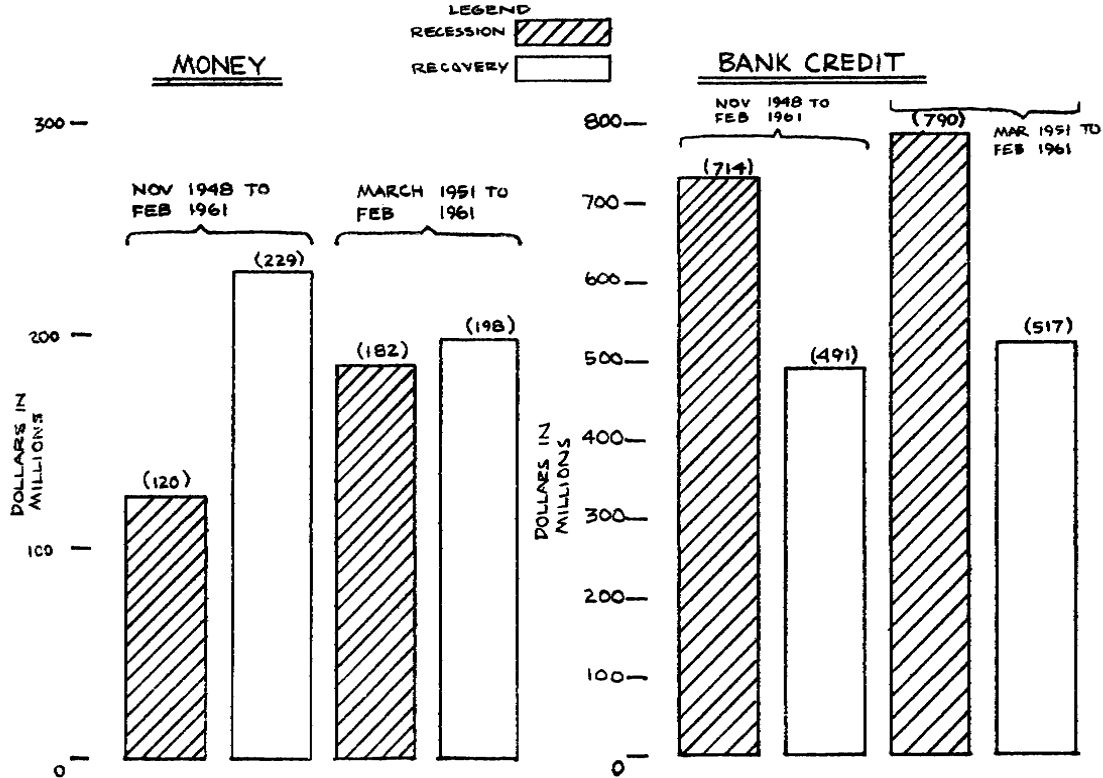

This has hindered them in their ability to carry out the mandate of the Congress.

Let us turn briefly to another issue, the Federal Reserve's understanding of the behavior of the stock of currency. This is an issue of great importance. The Federal Reserve apparently failed to recognize and clearly failed to offset the severe contractive effects occasioned by the public's demand for currency at several times during 1929-33. Have they learned to appreciate the importance of understanding cyclical behavior of the demand for currency as a factor in the cyclical behavior of the stock of money and the economy? Our conclusion is that they have not. Their statement to Congress in 1952 denies any important effect of the demand for currency on "the adequacy of the money supply."<sup>5</sup> To be sure that this view continues to represent the state of their analysis they were asked to discuss the problem of currency in a questionnaire to be published as a part of our report to this committee. Neither the Board of Governors nor the 12 Reserve bank presidents mentioned the cyclical problem of currency demand, although the seasonal and longer run problems were discussed. We can only conclude that the Federal Reserve has not yet recognized the cyclical nature of the demand for currency.

Chart III clearly reveals that cyclical fluctuations in currency demand have played an important role in the postwar period. Currency patterns dominated the behavior of the money supply in the immediate postwar period, they exercised a severely negative effect on the money supply in the early months of 1962 and contributed to the totally inappropriate reduction in the money supply in that year; they offset a severely contractive Federal Reserve policy during the recession of 1954 and eventually led to monetary growth despite perverse Federal Reserve policy.

This evidence of lack of basic understanding of the monetary process can be illustrated by a number of additional examples. Many of these are contained in the committee report to which I have referred. All of our examples lead to the same conclusion: The Federal Reserve does not have a rational foundation for policymaking.

#### SOME SUGGESTED CHANGES

Two features of the Federal Reserve System seem to account for their failure to analyze and test their conception of the monetary process. First, their analysis and their approach to monetary policy is dominated by extremely short-run week-to-week, day-to-day, or hour-to-hour events in the money and credit markets. Second, their viewpoint is frequently that of a banker rather than that of a regulating authority for the monetary system and the economy. This should not be construed as an attack on the motives of the men involved. Our point is simply that they are accustomed to consider their problems in much the same way that a banker considers his. But the questions that they have to decide are quite different from those that face an individual banker. Their concern with extremely short-run details inhibits careful analysis and the development of a tested frame of reference capable of providing answers to questions such as those discussed in the previous section.

<sup>5</sup>"Monetary Policy and the Management of the Public Debt" (Washington: Joint Committee on the Economic Report, 1952), pt. I, p. 338.

CHART III

$$\triangle C \frac{P}{T} = C \frac{P}{T} - C \frac{P}{T} - 12$$

Annual Changes in Currency Between Corresponding Months

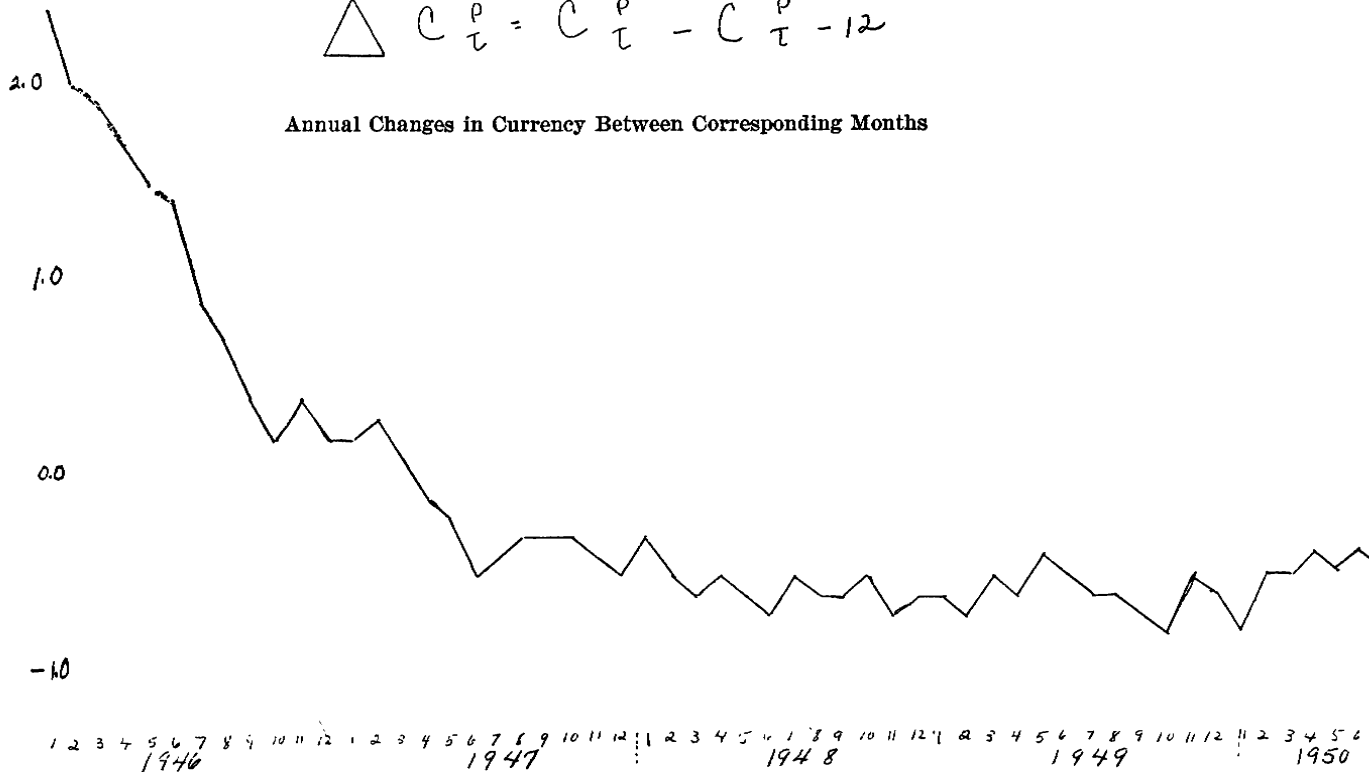

CHART IIIa

$$\triangle C \frac{P}{t} = C \frac{P}{t} - C \frac{P}{t-12}$$



CHART IIIb

$$\triangle C_T^P = C_T^P - C_{T-12}^P - 12$$

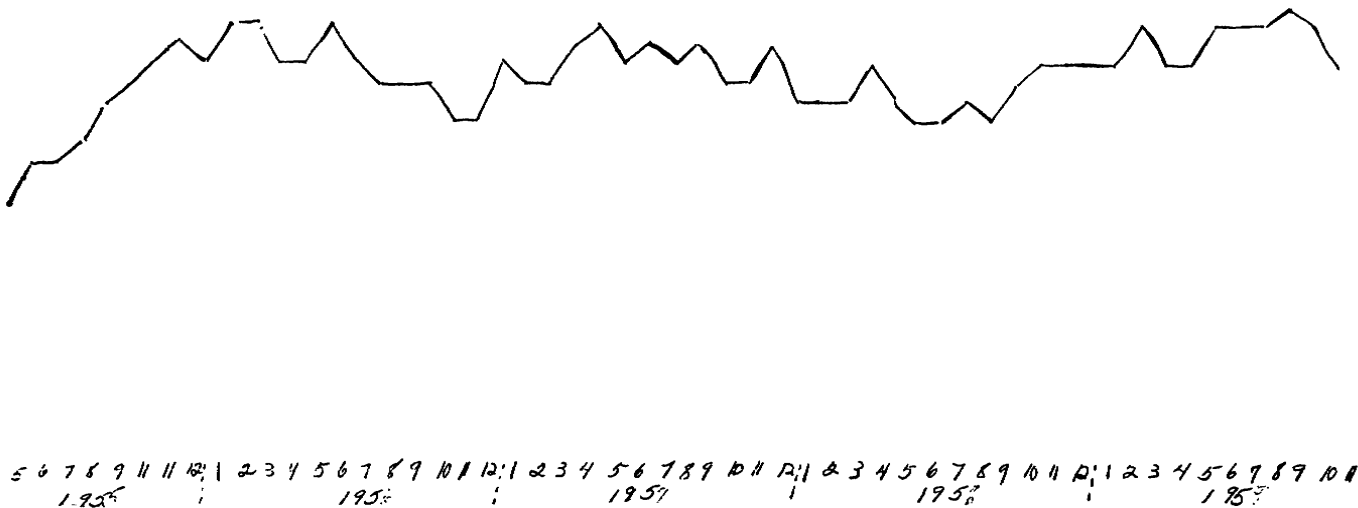

28-680-64-Vol. 2-2



CHART IIIc

$$\Delta C \frac{P}{T} = C \frac{P}{T} - C \frac{P}{T} - 12$$

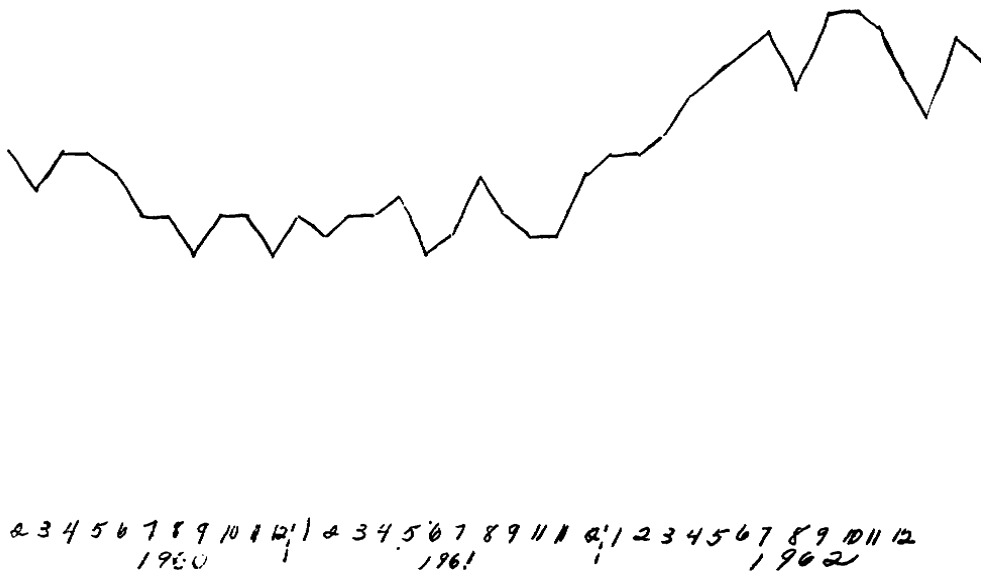

Changes in the legal and internal framework of the Federal Reserve System should attempt to remove the causes of present weakness. This requires elimination of the problems and procedures that have dominated Federal Reserve thinking and action.

One important step in that direction would be the requirement that the Federal Reserve report publicly on their detailed analysis, and the evidence supporting their analysis, of the monetary process and of the link between policy actions and the money supply. Such reporting would permit an audit of their analysis by outsiders and would lead to helpful communication between the Federal Reserve, the Congress, the academic community, and the public. I can think of no more important first step to eliminate the errors that continue to pervade their thinking, nor can I suggest a part of their responsibility that they have been more reluctant to carry out.

A second suggested change would remove from consideration many of the short-run problems that seem to dominate Federal Reserve thinking. To accomplish this, the discount window at the Reserve banks should be left open. Borrowing should be a right, not a privilege of membership in the System. A penalty rate should be charged for discounting or borrowing at the Reserve banks. Under the proposed arrangement, the Federal Reserve would control the base for monetary expansion, bank reserves plus currency. Banks could use the discount window to obtain reserves for their settlements, but such borrowing operations would be offset by open market operations. The Federal Reserve would have responsibility for controlling the quantity of money; the individual banks would be responsible for their own daily and weekly reserve adjustments to float, redistribution of deposits from Reserve city to country banks, and other extremely short run problems.

Third, the Federal Reserve would be left with the principal task of deciding on the quantity of money that should be available at the end of 6 months or a year. With adequate analysis of the relation of monetary policy to the stock of money and the observed ability of the Federal Reserve to judge turning points, direct concern with and concentration on this question would greatly improve policy operations. Policy should not be decided for a 3-week period only, as it is under the present arrangements that are dominated by concern about movements of tax and loan balances, float, Treasury borrowing, and so forth.

Fourth, the Federal Open Market Committee should be abolished and the power transferred to a Board of Governors that has been reduced in size. Two major postwar studies of Federal Reserve policy-making reached the same conclusion.<sup>6</sup> Although the analysis supporting my conclusion differs from that of the earlier studies, I concur in the conclusion of the earlier reports. The suggestion that Chairman Martin made earlier in these hearings indicates a willingness to accept a smaller Board.

The detailed nature of the findings that suggest these recommendations and many others cannot be presented in this statement. But they

<sup>6</sup> G. L. Bach, "Federal Reserve Policy Making." (New York: Alfred Knopf, 1950). The author of the study was Chairman of the Hoover Commission task force that studied the Federal Reserve. See pp. 222-226, 233-237. "Money and Credit, the Report of the Commission on Money and Credit." (Englewood Cliffs: Prentice-Hall, Inc., 1961), pp. 87, 90.

are based on analysis, supported by evidence, that will be available in the near future. A relevant conclusion drawn from that analysis is that discretionary monetary policy can do a better job of carrying out the congressional mandate than it has done in the past 50 years, if monetary policy is based on a validated and coherent framework. The proposals made are designed as a first step toward that end.

The CHAIRMAN. Therefore, if you will summarize it, Dr. Meltzer, it will be appreciated.

**STATEMENT OF ALLAN H. MELTZER, PROFESSOR OF ECONOMICS,  
CARNEGIE INSTITUTE OF TECHNOLOGY, PITTSBURGH, PA.**

Mr. MELTZER. Thank you very much, Mr. Patman, members of the committee.

I do not plan, in my remarks, to make reference to particular bills. I wish to provide some background information, and I will be happy to answer any questions about the bills or about the history of the Federal Reserve System to the extent that I know it.

The question to which I want to direct attention is the minimum requirements for an effective monetary policy. There are really two. One is that there be a close predictable relation between money and income, that is, that changes in the growth rate of the money supply have some reflection in the pace of economic activity.

The second requirement is that there be a relation between Federal Reserve policy and changes in the rate of growth of the stock of money. Unless we can answer both of these questions affirmatively we can neither hope to control inflation, reduce unemployment, or carry out any of the mandates that Congress has entrusted to the Federal Reserve System.

The CHAIRMAN. Now, money and income is the first one. What is the second one?

Mr. MELTZER. The second one is the relation of the Federal Reserve's policy to the supply of money.

Now, on both of these questions we have accumulated a large amount of evidence in recent years. For one, the relation of money to income, I have prepared a chart that represents just a part of the findings that come from a variety of different countries and from many different time periods.

Monetary factions have been shown capable of predicting every turning point since 1925 on an annual basis and predicting almost all the turning points in economic activity during the century.

These predictions are based not only upon changes in the money supply but also some other variables that determine velocity. But the primary variable that we are interested in, and one of great importance in making these predictions, is the stock of money.

Karl Brunner and I have attempted to do some preliminary studies for this committee to compare quarterly predictions with actual changes in national income from the fourth quarter of 1954 to 1959.

This should read "billions" over here and not "millions."

And we find again——

The CHAIRMAN. Without objection we will place the chart in the record at this point.

(The chart referred to will be found in Mr. Meltzer's prepared statement on pp. 926-938.)

Mr. MELTZER. Thank you.

We find again that there is a close and predictable relation between the rate of growth in the stock of money and the rate of growth of income.

Monetary policy is not simply a matter of pushing on strings, as the Federal Reserve has at times maintained. It is a most important part of the procedure by which we attempt to control inflation and promote full employment in our society.

The CHAIRMAN. What are the years there?

Mr. MELTZER. This starts in the fourth quarter of 1954 and goes quarterly along to the end of 1959.

And here we find that the relationship is very close. As a matter of fact, the average error that we make is about  $1\frac{1}{2}$  percent of income at an annual rate.

Mr. REUSS. Mr. Chairman, may I ask a question at this point?

The CHAIRMAN. Go ahead.

Mr. REUSS. The black line is—

Mr. MELTZER. The actual income, and this—

Mr. REUSS. What do you mean by "actual income"?

Mr. MELTZER. That is the national income that we had in a particular quarter. For example, let's take one of these. This period is the third quarter of 1959. The level of national income, at that time, was somewhere in the neighborhood of 425 or 430.

The red line is our prediction.

Mr. REUSS. What do you mean by your prediction?

Mr. MELTZER. It is a forecast. For example, to predict the third quarter of 1959 we used information only available up through the second quarter of 1959. These predictions are based upon the demand and supply for money or factors influencing the demand for and supply of money.

Mr. REUSS. Well, will you tell me a little more about the formula which you used for deriving your red line? Otherwise, the chart will not mean much to me.

Mr. MELTZER. Yes. The red line is produced by taking the stock of money. Essentially, that depends upon Federal Reserve policy, changes in the public's desire to hold currency and time deposits, and we make our predictions from that.

That is for the supply of money. The demand of money is represented in this case by velocity. It is dependent largely upon interest rates and wealth and some other variables that are rather technical, and I prefer not to go into them, but essentially it is based on interest rates and some other factors.

Mr. WIDNALL. Why does your chart end with 1959?

Mr. MELTZER. Because one of the variables that we used here is the total wealth available in the economy, and that variable is only available to make predictions up to the end of 1959.

Mr. Goldsmith and the national bureau compiled that series up through 1958, and some other people extended it through 1959. But there is no more available data from which to make further predictions. So we cannot go beyond that year.

But we do have a very strong relationship between changes in the stock of money and the level of income.

Although we cannot make these predictions because we do not have all of the elements to put into them, we do observe that after 1959, as

the chairman just indicated, the rate of growth of money supply slowed down. From 1959 until late 1962 the rate of growth of money supply was extremely low, one of the slowest periods in recent history.

Mr. WIDNALL. The Federal Reserve System has to predict things 3 weeks in advance. You say you cannot do it because you do not have any figures since 1959?

Mr. MELTZER. That is correct. We are not using the chart to indicate Federal Reserve policy, sir.

We simply want to show that for a long period of time money has had a very, very close relation to income and, therefore, the first condition for an effective Federal Reserve policy is being met; namely, that there is a relation between money and income. We know that for the period following 1959, when the rate of growth of the money supply slowed down and the rate of growth of income also slowed down. In late 1962 and early 1963, when the rate of growth of money supply increased again, the rate of growth of income increased again.

So the basic features that are revealed by the chart are also revealed by our contemporary history.

Mr. REUSS. I have another question. I gather that this is not simply a chart of the national income for a particular period, compared with the money supply for that same period.

Mr. MELTZER. No, it is compared with a prediction of income based upon the money supply and some other factors.

Mr. REUSS. Yes.

Mr. MELTZER. In other words—

Mr. REUSS. Are we being told what those other factors are, because otherwise I do not get much—

Mr. MELTZER. The other factor is velocity, that is the rate of turnover of the stock of money. That factor is predicted by interest rates and some other things, the ratio of income to permanent income, the transitory component of income and a measure of the return on real capital.

The CHAIRMAN. Are you saying that as the interest rate increases the velocity of money decreases?

Mr. MELTZER. No, as the interest rate increases velocity increases, and we multiply money times velocity to get income; that is, money times our prediction of velocity gives us a prediction of income.

Mr. REUSS. A couple more questions. You talked about predicted income. Were you and your associate, during these years, actually sitting there with a crystal ball, or is this an ex post facto reconstruction?

Mr. MELTZER. Ex post, but to make this prediction, or any one of these, we used only information we would have had had we been sitting there forecasting at the time.

We used information on what had happened up to one quarter before the prediction we wanted to make.

So we could have made these predictions at the time just as well as at the present time.

Mr. REUSS. Let me ask this question: I have long observed the correspondence between the money supply, properly defined as demand deposits and currency outside banks, and national income and also gross national product. Does your chart tell us anything more than that?

Mr. MELTZER. Yes, I think a little bit more.

The other factor that enters into the determination of income with money is velocity, that is, the rate of turnover.

If we take the stock of money and multiply it by the number of times that money turns over to generate income, we have a prediction of the level of income itself.

Now, velocity can change. We take interest rates and we include some other things that our theory tells us are important, for example, the ratio of income to permanent income, and some other technical things. That way we get not simply a gross association between money and income but we get a prediction of what level of income should be from monetary factors, and this tells us a great deal more, I think, about the confidence that we can place in the relationship of money to income.

It tells us, for example, that we can use this procedure if we continue to collect information on stock of wealth, to predict income ahead of time.

The CHAIRMAN. Suppose, Doctor, you go ahead and briefly cover your charts and your testimony, so that we can have Dr. Gordon, and we will ask each of you questions then.

Mr. MELTZER. Now, the second question that comes up is how well does the Federal Reserve control the money supply.

If money is important as a predictor of income, how well is the Federal Reserve's control over the stock of money. Here again we have broken that question down into two parts.

One is the question: Do they recognize the turning points in economic activity? Do they know when it is that recession occur? As I have indicated in my statement and as Dr. Bruner and I have indicated in the report, the record in the postwar period is excellent. We do not believe that very many people in the current state of knowledge, could have done better in recognizing turning points, than the Federal Reserve has done. But judging turns is not enough.

They have to know what to do when the turning points occur. Now, this, we think, is their greatest weakness, not knowing what to do. They do not have a valid, appropriate understanding of the money supply process. In 50 years they have not developed one.

Now, one or two statements will develop this point in more detail.

One has to do with their discussion of credit rather than money. For example, Chairman Martin, of the Federal Reserve System in response to a question asked by the Joint Economic Committee, submitted a written statement saying that monetary and credit expansion are two sides of the same coin. In these hearings many Federal Reserve people have talked about credit expansion.

Now, we observe the following. These black areas represent average monthly changes in money or in credit during periods of recovery. These are periods in which we are moving from the bottom to the top. The problem becomes one of preventing inflation.

What we find is that the Federal Reserve permits a larger rate of growth in the money supply during the periods when they should be controlling inflation, and a smaller rate of growth in the money supply during periods when they should be preventing unemployment.

Their policy is in terms of bank credit not money. We see that they allow bank credit to increase very rapidly during periods of unem-

ployment. That is because the banks are acquiring Government securities in place of loans or there is a spillover from money into time deposits. However, we find that the rate of growth of the money supply is slow when it should be fast and fast when it should be slow. It is not countercyclical.

Therefore, many of the problems that we have had, such as the sluggish rate of growth, and the slow decline in unemployment, as well as the problems of rising prices, are due to the Federal Reserve's policy. They increased the money supply too quickly when they should retard it and too slowly when they should accelerate it.

And this, we think, is the major weakness. This weakness emerges from their lack of understanding of the process that they have been entrusted to control.

They have never made any detailed studies about monetary and credit expansion or they would not say that the two rates are the same. Their statement that the two rates are the same is totally incorrect. It is a factual question and it can be observed in the chart that it is factually incorrect.

Now, the third chart that I would like to present deals with currency. They have been asked several times, by this committee, and in a questionnaire that this committee sent to the Federal Reserve people for us, this question: Do they believe that swings in the public's currency behavior are important? They deny that these are of importance cyclically. Yet all we have to do is look at the evidence and we observe that cyclical changes in currency are very important.

For example, they help us to explain some very puzzling things. In 1946 the public's demand for currency decreased very rapidly. This permitted an expansion of the money supply that was inflationary during that period despite the fact that the Federal Reserve was making lots of statements to the effect that they were trying to control inflation. They ignored the currency behavior of the public and they misjudged the situation.

In 1953-54, during the recession, the Federal Reserve was pursuing an inappropriate policy. They were consistently compressing the policy variables and reducing the money supply, thereby fostering further unemployment.

But the public's currency behavior came to our rescue. It declined so steeply in the 1953-54 recession that it reversed the incorrect policy action taken by the Federal Reserve and thereby permitted growth of the money supply and helped us recover from that recession.

In early 1962 the public's currency demand was strong. As currency rose, it caused a fall in the money supply. During the early part of 1962 the money supply was allowed to decline despite rising unemployment.

Now, the Federal Reserve has announced that they moved to slightly less easy policies in 1962. That is the statement published by the manager of the System Open Market Account. But the public's currency behavior reversed, and the money supply grew rapidly during the period in which they claimed to be less easy.

In fact, it went from a negative rate to one of the highest positive rates of growth in the postwar period.

Again we can observe the facts and conclude that the Federal Reserve has misjudged the behavior of the stock of money. This occurs

because they do not have a validated understanding of what it is that they have been entrusted to control; namely, the stock of money.

So, to very briefly conclude my remarks, I would like to say that while we have a number of detailed recommendations about how the System could be improved, we think that there is no more important thing that could be done than to have them submit annually on the public record, not only a statement of the actions that they have taken but a statement which tells us what their analysis is, how did they incorporate all of these monetary factors, what is their analysis of the factors governing the money supply, and what is their evidence to support it.

And I think that if we begin to do that the next 10 years will show an improvement in policy over the poor record that the Federal Reserve has achieved in the past.

I would like to make one last remark which, I think, is of some consequence; namely, that their failure to analyze the currency demand is of great importance, because it is one of the primary elements that they have misinterpreted or ignored.

From their statements and from their behavior in the postwar period we have no reason to believe that they would not make the same mistake with respect to currency in 1964 that they made in 1932 or 1933.

Thank you.

The CHAIRMAN. Thank you, sir.

All right, Mr. Gordon, we are glad to have you, sir, and you may proceed in your own way.

**STATEMENT OF H. SCOTT GORDON, PROFESSOR OF ECONOMICS,  
CARLETON UNIVERSITY, OTTAWA, CANADA**

Mr. GORDON. Thank you, Mr. Chairman.

These brief comments will be directed at H.R. 9631, which is one of those before the committee.

In considering the proper form of organization of a modern central bank it is above all necessary to appreciate the fact that a central bank is an instrument of government, and its acts are acts of governing. The generic term "Central Bank" and specific names such as "Federal Reserve Bank," "Bank of Canada," "Bank of England" convey the impression that central banks are similar to commercial banks and other types of private banks. Central banks and private banks both deal in money and financial instruments, but their similarities end just about at that point. The differences between them are much more profound than these similarities. Private banks are business institutions, they enter the financial markets as primary participants; in effect offering their various services for sale, just as any other business does. Central banks enter the same markets, but in the role of controllers and regulators; they do not produce and exchange, they govern.

It is almost platitudinous to say that it is desirable that the regulatory activities of a central bank should be in harmony with the other regulatory activities pursued by the government of the country. In the case of monetary regulation, however, we see a very complex application in practice of this simple point. Different countries have tried to assure this harmony of policy in different ways.



At one extreme, there are central banks that are established as independent entities, with autonomous financial power and legal rights of regulation, and with legal protection of their senior officers against governmental pressure. In such cases, harmony of central banking with other governmental policies may depend on nothing more concrete than a statement in the statute establishing the bank that it should strive to promote the general economic good and avoid economic evil. The Bank of Canada is an illustration of such an approach.

At the other end of the spectrum, a central bank may be established as a fully integrated part of the executive branch of the Government—subject to executive authority in all matters relating to its policy and operations. My interpretation of H.R. 9631 is that it would make the Federal Reserve System into such an agency.

There are a large number of intermediate constructs in the world of central banking today. These consist of central banks which are formally autonomous and independent of government, but which may be brought under the Government's influence in various ways. For example, in Great Britain, the chancellor of the exchequer is legally empowered to issue specific directives to the Bank of England, which the latter is required to follow.

The object of much central banking legislation seems to be to assure that the bank's policies will be in harmony with those of the Government, while leaving the bank free of governmental control and influence in the pursuit of its day-to-day operations. The view that operating independence is desirable springs largely from the fear that the executive branch may be tempted to misuse the great financial power of the central bank by perverting it to partisan or even personal ends. To my mind, such evils are possible in all spheres of governmental operations, and the real guarantee against them is the light of public knowledge. The sphere of finance does not inherently contain greater dangers of this sort than those of, say, defense or public works. The Federal Reserve already has an enviable record for furnishing information which permits searching public discussion and criticism of its practices.

It furnishes a great deal more information on these deliberations, practices, and discussions within the System than we have in Canada.

No doubt this could be extended and thereby provide even greater guarantees against the misuse of financial power by the executive branch.

Some authorities argue for central bank independence on the ground that governments are inclined to be inflation prone, and an independent central bank will check this tendency. Without examining the validity of this contention here, I would point out that this view is a plea for the independence of the central bank in setting its basic policy, not merely in its day-to-day operations. Such a view cannot be logically held by anyone who believes that the policies of the central bank and the Government should be harmonious.

In Canada we have had some direct experience with the undesirable consequences of central bank independence. The events preceding the attempted dismissal of the governor of the Bank of Canada in 1961 showed that central bank independence can degenerate into irresponsibility, and that the Government itself can make use of the

autonomous position of the central bank to deny its own responsibility for what it conceives to be politically unpopular policies. We have not yet fully recovered, in Canada, from the consequences of the acrimonious controversy between the Bank of Canada and the Government in 1960-61, and we have not yet resolved, by appropriate statutory changes, the formal weaknesses in our central banking legislation that permitted those unfortunate events to occur.

I have myself argued, in my own country, that central bank independence is an anomaly in the modern world, and that the Bank of Canada should be reconstituted with the status of an ordinary department of government. Since this is the effective status that, as I interpret it, H.R. 9631 would give to the Federal Reserve System, I am not therefore inclined to be critical of this bill on general grounds.

I would add, however, that the Canadian political system calls for such a change in the status of the central bank more clearly than does that of the United States. In Canada, the full integration of the central bank into the executive branch of government is demanded both by the requirements of good economic policy and by the basic constitutional theory which underlies parliamentary government; in the United States it would seem that only the economic argument is fully applicable, though that alone is a very strong one in the light of the important role we expect monetary management to play in the modern economic world.

The CHAIRMAN. Now, Mr. Gordon you mentioned the question of whether or not the Government and the monetary authorities should act in harmony.

Is it the general rule in the other central banks of the world, in major countries, that the monetary authorities, the money managers, and the government do work in harmony or not?

Mr. GORDON. I think it is the general experience that they do work in harmony, and the informal arrangements that one usually discovers between the monetary managers and the government, represented usually by a minister of finance or treasury are much more important than the formal ones.

For example, in the British case no directive has ever been issued by the chancellor of the exchequer, and such a directive would be a public acknowledgement that the real mechanism had broken down, which is the mechanism of informal discussion. And I think that our own experience—

The CHAIRMAN. Wait just a minute though. You state here, for example, that "for example, in Great Britain, the chancellor of the exchequer is legally empowered to issue specific directives to the Bank of England, which the latter is required to follow."

But you now state that no directive has ever been issued?

Mr. GORDON. No directive has ever been issued.

The CHAIRMAN. Yet, he has the power, if he desires to do so?

Mr. GORDON. Yes.

The CHAIRMAN. Now, be a little bit more specific with my question, if you please, in reply.

I have here as an example, Belgium, and in that country the Government owns 50 percent of the central bank, and I understand the stock of the bank is traded on the exchange, but the Government controls the Central Bank of Belgium.

Is that correct?

Mr. GORDON. Yes; I believe so.

The CHAIRMAN. And in Canada, of course, the central bank has been 100-percent Government controlled since 1938; France, 100-percent Government owned since 1946; and Germany 100-percent Government owned since 1957, since their incorporation.

In Italy a majority of shares are held by savings banks and are managed by several large commercial banks and insurance companies and social security institutions.

Well, is it controlled by the Government or does it work in harmony with the Government or does it not in Italy?

Mr. GORDON. I cannot speak for the Italian case, Mr. Chairman, but the Canadian case demonstrated most clearly that ownership of the bank is no guarantee of control, in any sense.

The Minister of Finance, in right of the Crown, holds 100 percent of the shares of the Bank of Canada and yet he was powerless to intervene in the policy of the bank and, indeed, he was even powerless to require the Governor of the Bank to meet with him to discuss banking policy.

There was—

The CHAIRMAN. In other words, they had gotten off and considered themselves somewhat independent?

Mr. GORDON. More than somewhat independent.

The CHAIRMAN. Now, I will take Japan. Japan, since the central bank was established in 1882, the Minister of Finance has owned 55 percent of the stock.

Generally, do the monetary authorities and the Government of Japan work in harmony or not?

Mr. GORDON. I cannot say, sir. I do not know.

The CHAIRMAN. What about the Netherlands? Of course, that is like Canada. It has been a 100-percent Government owned bank since 1948.

Sweden has been a 100-percent government-owned bank since 1668, and Switzerland is a joint stock company 55 percent owned by Cantons and managed by a large number of private shareholders. It generally works in harmony with the Government, is that not correct?

Mr. GORDON. Yes. However, the degree of ownership does not again correspond with the degree of independence of the bank.

The CHAIRMAN. Well, that is true here in this country, Mr. Gordon.

You see, the Federal Reserve banks are 100-percent Government owned, by the U.S. Government.

Of course, this so-called stock that they try to make out causes this ownership to be in the private banks; we have an awful time getting over the true facts concerning that but, generally, now, anyone who knows anything about it at all knows that the word "stock" is a misnomer—that the "stock" does not carry any proprietary ownership of any type or nature.

Mr. WIDNALL. Mr. Chairman, will you yield at that point?

The CHAIRMAN. Yes.

Mr. WIDNALL. What was the Government's investment in the Federal Reserve System?

The CHAIRMAN. The credit of the Nation. That is the best investment on earth. It is 100 percent. It is everything.

It is a mortgage on everything that you have, the income of all the people, and the taxing authority carries it out.

Mr. WIDNALL. As evidenced by stock?

The CHAIRMAN. As evidenced by the fact that Congress has given that power. There is no stock held by anyone except the private banks. That is where the misapprehension came about, about the ownership of the banks.

Mr. WIDNALL. Well, these other countries, are they not judging the credit of a nation by buying stock?

The CHAIRMAN. Well, we could buy stocks here but it would be meaningless. There is no stock really owned. That stock that is outstanding is not stock.

Mr. WIDNALL. Well, are you saying that in these other countries then it is meaningless for the government to buy stock in the banks?

The CHAIRMAN. Yes, of course, as long as they control it that is all they need because they operate on the credit of the nation and they should control it.

Now, the United Kingdom, the entire capital stock of the Bank of England has been held in the treasury since 1946.

As Mr. Gordon says, it does not always mean that because the government owns all of the stock, it does not necessarily mean that it is government controlled.

Just like Canada, they had a very sad experience in 1960 and 1961; did you not, Mr. Gordon?

Mr. GORDON. Yes, indeed, sir.

The CHAIRMAN. In which the bank was getting off to itself. Like I have often said, our Federal Reserve System attempted to secede from the Government in 1951 by getting off to themselves and running the whole show.

That is what we are fighting against and what we have been fighting against ever since that time or at least what I have been fighting against.

Now, I will ask a question of Dr. Meltzer—

Mr. WIDNALL. Mr. Chairman, at that point, did not Dr. Meltzer say that their record since 1951 was unassailable?

The CHAIRMAN. I did not understand it that way.

Mr. MELTZER. No, that was not my statement. I said their record in predicting or observing turning points was unassailable, but their record in taking appropriate action was very poor after they had seen them.

Mr. WIDNALL. Well, can you predict what will happen internationally?

You have been very dogmatic and absolute in your criticism of the Federal Reserve—

Mr. MELTZER. That is quite correct. We have a report that will be presented to this committee. We have evaluated in great detail the Federal Reserve's record of control of the supply of money in the United States.

We find that record to be very poor, largely because they have a very inadequate understanding of the factors governing or controlling the supply of money.

Partly because the record is so poor—we then raised the question, maybe control of the money supply is impossible. Maybe our control over the money supply is so bad that Federal Reserve policy is the best as we could do under the circumstances.

So we present our own ideas and our own conception about how the monetary system works. I am not exactly sure of the figures, but the results are something like this, sir—the very best that we can find for the Federal Reserve is a control over approximately 40 percent of the monthly change in the money supply.

The worst that we can find, for our conception, is a control over about 85 or 90 percent. So we conclude that their record is very poor because they have not understood the process. They have not analyzed the determinants. We give them great credit and we say their record is unassailable in judging turning points. But they do not know what to do thereafter.

Mr. WIDNALL. Are you not, in your evaluation, looking back all the time and the Fed has to look forward?

Mr. MELTZER. That is an element in the process. We have based our findings on an analysis of events that have occurred. But that is not the major point.

They have to look forward, but what we are asking is when they take their actions—in which they apparently have confidence—that they base their actions on a theory or framework that has been shown to work in the past.

All we have to do is look at the chart, the chart No. 2 that is in the statement that I prepared for the committee and observe that the rate of credit expansion has been countercyclical in the postwar whereas the rate of monetary expansion has not been countercyclical.

Mr. WIDNALL. May I ask one more question? I do not want to impinge on your time, Mr. Chairman.

The CHAIRMAN. Surely.

Mr. WIDNALL. Dr. Meltzer, would not restrictions on the growth of credit in the times of good business drive interest rates higher and have very adverse effects on the percentage of unemployment?

Mr. MELTZER. No, sir. What we want to achieve, I think, is very well stated in the Employment Act.

What we want to do is have maximum employment and maximum purchasing power. Now, to do that, through discretionary monetary policy, means that we are going to have a faster rate of growth in the money supply during periods of unemployment and a slower rate of growth in the money supply during periods of inflation, and that is the opposite of what we observe the Federal Reserve has been doing in the postwar period.

Mr. WIDNALL. Well, I still do not understand that as an answer to my other question.

Would not restriction on the growth of credit in times of good business drive interest rates higher, and then have an adverse effect on the percentage of unemployment? Why would it not drive interest rates higher?

Mr. MELTZER. Oh, the restriction of monetary growth does drive interest rates higher given the demand. That is absolutely correct. But that is the process by which we control inflation.

Mr. WIDNALL. But does not that have an adverse effect on unemployment?

Mr. MELTZER. No, sir. When inflation threatens, we want, in effect, to ration loans through the interest mechanism by having high interest rates. We want to deter some borrowers, to get them to postpone their expenditure to some period when we have less demand. That is how we even out some cyclical up and down swings.

Is that responsive to your question?

The CHAIRMAN. In other words, Dr. Meltzer, you stated the Federal Reserve's record in the past 50 years is unsatisfactory on predicting the amount of money or the volume of money that should be in circulation?

Mr. MELTZER. Not in predicting it, sir, but in controlling it. It is the relationship between the policies that they pursue and the money supply that they do not understand.

Now, the basis of our position with respect to that is—I think can be simply stated in the following way:

If credit were the most important thing then their policy would be quite appropriate, but they have provided no evidence that credit is the most important thing, and we have been able to find none. What we have found is that money is very important and their record is very poor because they confuse money and credit.

The CHAIRMAN. During the last 50 years then, since 1913, when the Federal Reserve Act became law, by decades has there been a real decade of good, you might say, conduct—which is not a good word to use—but, in other words, has the record of the Federal Reserve System been good in any decade during the last 50 years?

Mr. MELTZER. Well, let me just run through them.

In the first decade, of course, they ran into World War I and there, of course, they provided an extremely rapid rate of increase and an inflationary increase in the money supply.

In 1921 they did a very poor job in handling the recession of that year.

The CHAIRMAN. We had a cruel recession that year.

Mr. MELTZER. Yes, very serious. And I would say, in general, the answer is that there has been no complete decade in which their policy has been very adequate.

The CHAIRMAN. During the entire 50 years?

Mr. MELTZER. That is right.

The CHAIRMAN. All right. Mr. Widnall?

Mr. WIDNALL. Dr. Meltzer, I would like to have a little bit better knowledge of your own background.

Where did you study and what work have you done since?

Mr. MELTZER. I was an undergraduate student at Duke University in Durham, N.C.

I then became, for a number of years, a self-employed businessman. I worked at that for about 4 or 5 years until I returned to graduate school at the University of California, in Los Angeles, I think, in 1953, and I stayed there until 1955.

I then went to France, wrote a thesis on French inflation, and the problems of the central bank, and of quite some relevance here went into the reasons why the central bank was largely responsible for that inflation through their inappropriate policies. I returned and I taught by the University of Pennsylvania for a year, and since that time I have been at the Carnegie Institute of Technology in Pitts-

burgh, and I have been working on monetary, primarily on monetary problems. I have been a consultant to congressional committees, the Treasury, and commercial banks.

Mr. WIDNALL. Are you presently on the staff of the committee?

Mr. MELTZER. Yes, I am, sir. I am a part-time member of the staff.

Mr. WIDNALL. Are you appearing today as a staff member?

Mr. MELTZER. I believe—

The CHAIRMAN. He is appearing as an economist, as a witness.

We felt that he is so well known in the type of work that he is doing that he could make a great contribution to this committee in starting off the series of hearings that we are now conducting. And he is only part time on the committee.

Mr. WIDNALL. Do you have any charts, Dr. Meltzer, that would show the relationship of the price level in this country to the fluctuations that you show?

Mr. MELTZER. For this period?

Mr. WIDNALL. With respect to velocity and with respect to money and credit?

Mr. MELTZER. Yes. I have a chart here dittoed, and I will be happy to bring it up to you, sir, showing the price level during this period.

Mr. WIDNALL. Is it not true that there has been considerable price stability in the postwar years?

Mr. MELTZER. Yes, there has been a reasonable amount of price stability particularly in recent years, although, I might add that I think we have to be very careful with the price indexes.

I think there is a Joint Economic Committee report indicating they have something of a bias in them, and we have to be very, very careful about concluding that a stable price level is really not a declining price level, and that a rising price level is not really a stable price level.

Small changes in one direction or the other are not terribly meaningful.

Mr. WIDNALL. Is it not true that pressures are being exerted against them—

Mr. MELTZER. Indeed, it is.

Mr. WIDNALL. Is it not true the price level or the stability of prices is one of the most important things for the low-income people of the country?

Mr. MELTZER. Yes, it is. I have written to some extent on the problems of controlling inflation and the answer is "Yes," particularly for those on pensions, but it is also very important for creditors.

Mr. WIDNALL. Now I would think, from what I have seen in recent years, that the record has not been too bad on keeping price stability in this country.

Mr. MELTZER. I would say that my judgment of that record is that prices have probably declined; that is, actual prices have probably declined during the period and that policy was somewhat deflationary from 1959 to 1962. As a result unemployment rates rose.

So that on that ground I would conclude that policy has not been bad in the last year. But we also have to ask the question to what extent is the Federal Reserve responsible for the growth of the money supply last year and to what extent is it simply a fortuitous event that

they have not fully understood? I think we can make a very strong case for the fact that it is largely a fortuitous event.

May I elaborate on that, sir?

Mr. WIDNALL. Surely.

Mr. MELTZER. 1963 is a very good year to discuss, 1962-63.

I mentioned in my statement, in my earlier remarks, that it was precisely at the time that the Federal Reserve indicated that they had moved to a policy of slightly less ease that the money supply began to grow at a much more rapid rate. Their indication of a change in policy toward less ease was published in the Federal Reserve Bulletin by the manager of the account, Mr. Stone. Slightly less ease should mean that the money supply is going to be compressed, that growth in the money supply is going to slow down. But it is just at that time that the money supply began to grow faster.

Judged by free reserves that Mr. Hayes at these hearings and that Mr. Martin and others have used over and over again as the indicator of their policy—their policy has been tight. But judged by appropriate indicators, that adequately summarize Fed policy operations on the money supply, their policy has been easier since late 1962. So they misjudged the meaning or content of their policy, and I think there is a strong case to suggest that they do not understand, in any reasonable detail, the operations that they are conducting or their effect.

Mr. WIDNALL. Why is it that the most or most of the other large countries in the world, their interest rates and the rediscount rates are higher than in the United States?

Mr. MELTZER. That is a rather complicated question, but in part it is certainly due to the functioning of our financial system in this country, the absence of certain risk elements, the very well developed capital markets that we have in this country. We have a very active and efficient capital market and that is one reason that leads to a lower interest rate. The degree of risk and other factors enter into the interest rate level along with the demand and supply for money and other assets.

Mr. WIDNALL. Now, if the Federal Open Market Committee is so woefully lacking in understanding, the money process after years of close and careful study, do you believe that a board which has a tenure of no more than 4 years and an advisory board of 50 who are not schooled in monetary policy and have a term of only 1 year, can do a better job?

Mr. MELTZER. My own judgment, and this I think is the judgment of the Hoover Commission report or Mr. Bach, who prepared the Hoover Commission report, probably would be that the best arrangement might very well be a single man charged with the responsibility for this in much the same way that we deal with other administrative problems of the Government.

Mr. WIDNALL. Well, you do not find that in any of the bills that are presently pending before this committee, do you?

Mr. MELTZER. No, sir; I do not.

Mr. WIDNALL. What I just read to you is the monetary organization provided in H.R. 9631, on which you commented before, Mr. Gordon.

Mr. MELTZER. My comment?

Mr. WIDNALL. No; I said on which Mr. Gordon commented before.

Mr. MELTZER. Yes.



Mr. WIDNALL. That is all at this moment.

The CHAIRMAN. Mr. Reuss?

Mr. REUSS. Thank you, Mr. Chairman.

I am more interested in the policies of the Fed than in whether 1 or 5 or 7 or 14 can do it better. I applaud both of you gentlemen, Dr. Meltzer and Dr. Gordon, for getting into some of the fundamental problems of Federal policy.

What do you mean, Dr. Meltzer, by the "demand for currency"?

Mr. MELTZER. As you know, in what I think we both regard as the appropriate definition of money, currency, and demand deposits, the public is free to choose how it wants to hold its money.

The Federal Reserve makes available to the public, through the banking system, any amount of currency that it wants to have in exchange for deposits. So, generally the supply of currency is whatever the public wants it to be.

The supply of currency responds to the demand. But the public has at times desired to convert deposits into currency in great volume. The most outstanding example of this is, of course, the banking crisis of 1929-33 when the public en masse came into the banks and said, "We don't want demand deposits any more. We want currency."

Fortunately, we do not often have quite such dramatic events as that and we have not had one since 1933. But we have had bank runs in other periods of our history, and we have cyclical fluctuations in currency demand. These swings, on the order of \$2 to \$3 billion over the course of some years, are approximately 10 percent of the supply of currency.

Mr. REUSS. Let's just take the last 10 years because that seems to be when you did most of your work.

Is there any rhyme or reason for these variations in the demand for currency?

Mr. MELTZER. Oh, yes. They respond to—

Mr. REUSS. Name them.

Mr. MELTZER. They respond to income, the public's monetary wealth and various cost elements, the kinds of transactions to be made.

There is a well-known seasonal problem here—

Mr. REUSS. Oh, of course, at Christmastime and all of that—

Mr. MELTZER. This is also a cyclical problem, responding to the public's monetary wealth, costs and yields.

Mr. REUSS. Well, what are the factors that increase the propensity to demand currency instead of a demand deposit?

Mr. MELTZER. Well, among the factors, I think, several are well known.

The location of banks in shopping centers would, for example, be a factor affecting—a longrun cost factor affecting the currency demands of the public.

Now, superimposed upon that—

Mr. REUSS. Let's stop there and take them up one by one. Yes, but that is very long run indeed; is it not?

Mr. MELTZER. Yes.

Mr. REUSS. In 19th century society, there was a great propensity, I suppose, to demand hard cash because it was such a long trip to go to the bank to cash a check. But talking about just the last 10 years, there have not been any gigantic historical movements in this field, have there?

Mr. MELTZER. No, sir, that is right. The longrun movement is a minor influence in the whole problem, not of great significance for present purposes.

Mr. REUSS. Go on, if you will, then, but understand my position: I am sort of from Missouri on this, and I am not impressed, really, so far, with the proposition that there are great variations in demand by the American public for currency.

Mr. MELTZER. That, we can demonstrate. That is a fact.

Mr. REUSS. The whole line wiggles, but—

Mr. MELTZER. All right. Now, you would like to know—

Mr. REUSS. What rationale—

Mr. MELTZER. Fine. Let's go back to 1946.

Mr. REUSS. All right.

Mr. MELTZER. There we had a large decrease in the public's desired holdings of currency. Now that decrease was not wholly but partly associated with the end of the war.

Two factors during the war had a lot to do with the public's demand for currency. One was the much greater mobility of the population, servicemen, and wives traveling around.

That gave rise to a demand for currency.

Secondly, an unfortunately but probably quite important reason was the amount of black-market activity that was taking place and the number of transactions that were carried out in currency. Now, with the end of the war we see that there was a very sharp decline, something in the neighborhood of \$2 to \$3 billion over the course of a year and half.

All right. Now, thereafter the line wiggled around slightly, of no great consequence for this sort of analysis—

Mr. REUSS. If I may interrupt you, I suppose the demand for currency went down in postwar Germany even more markedly, because nobody in his right mind wanted currency. What you wanted was cigarettes or some better medium of exchange.

So when you deal with wartime or postwartime, I have no trouble following you, but in the last 10 years I cannot see anything but an undecipherable wiggle there. I cannot derive any great sociological laws from it.

Mr. MELTZER. May we take the swing here which, I think, is observable?

Mr. REUSS. From what year to what year, please?

Mr. MELTZER. This is from approximately the beginning of 1953 to somewhere in the neighborhood, I would judge, of August of 1954. All right?

That is within these years. Now, there we have a swing on the order of \$1.5 billion. That is a fairly large swing.

Mr. REUSS. Of people who—

Mr. MELTZER. Are reducing their holdings of currency.

Mr. REUSS. And putting them into demand deposits?

Mr. MELTZER. Into demand deposits, that is right.

Initially into demand deposits. They may ultimately go into other assets, but this had great or decisive influence.

The reason for that is that the Federal Reserve controls two elements; one, the reserves of banks and, two, the stock of currency.

Now, what they really control is the sum of these two because the public can switch deposits into currency. But when the currency goes back into the banks reserves it supports a larger amount of money than it does if the public holds it as currency, and it is for this reason, not because of the movements on here, but because of what happens that those movements take place that currency is of great importance. A swing of \$1.5 billion into the commercial banking system gives the banking system \$1.5 billion larger reserves. There is a multiple expansion of bank deposits based upon that.

Mr. REUSS. And is one of your complaints that the Federal Reserve has little or no control over swings in preference from demand deposits to currency?

Mr. MELTZER. No, sir. Our complaint is that they deny that they exist. They do not recognize them.

When they are asked a question, "Is this a problem for monetary control?"

Their answer is, "No problem at all." That is the answer that they gave to, I believe, the Joint Economic Committee, and that is the answer they gave to us.

But let's go to a more recent period, if I may, sir. Right here. Now, that looks like a small change but, given the scale that we have here, again we have a swing in this short period of 1 year of about \$1 billion in the public's currency holding.

That is a fairly large swing. The public only holds something in the neighborhood of \$30 to \$35 billion in currency. So that is a relatively large percentage change.

It also permits a much larger expansion in bank deposits. It was this swing—in this case an increase in currency and a contraction of bank deposits—that helped to produce a reduction in the money supply. It is one reason why the money supply fell in early 1962.

Although the Federal Reserve said at that time that its policy was easy, the money supply declined. We observed the same thing in 1949, incidentally.

Mr. REUSS. And what would you do about it? I take it that in—

Mr. MELTZER. 1961-62, yes.

Mr. REUSS. —any period like 1961-62, your view must have been that the money supply should be expanded—

Mr. MELTZER. Absolutely.

Mr. REUSS. —because our growth rate was insufficient and we had large reservoirs of unemployment demand power—just as we do today I take it you would have increased the money supply faster to counteract the diminution that was taking place because people were, for some reason, drawing on their bank deposits and getting the cash?

Mr. MELTZER. That is right, I certainly would. This is just one example. We could provide others.

We could provide evidence from the Federal Reserve's analysis or failure to analyze the swing into time deposits or any one of the many factors that determine the money supply.

I just chose two. The report that we prepared for the committee will contain others.

For many of these variables we find that at any particular time, they may be a small factor, but others may be important at that time. It is the combination of currency and time deposit demand with policy variables that determines money supply, and it is the failure of the

Federal Reserve to recognize most or, in fact, at times any of them as an influence in determining the money supply that we have discussed in our report.

Mr. REUSS. Isn't the major trouble with the Federal Reserve monetary policy in the last 10 years—I would not put it further back than that—that they simply have not given the economy sufficient increases in the money supply to support the higher level of economic activity that was necessary if we were to grow sufficiently and to find enough jobs to take care of those who emerged on the labor market for the first time or were displaced by automation? Is that not the real sin?

Mr. MELTZER. This has certainly been the problem from 1959 through 1962 or mid-1962.

In late 1962 they permitted a more rapid rate of expansion in the money supply, and in 1963 at times the money supply was growing at a rate of 6 or 7 percent.

Mr. REUSS. Yes, it is true that at times in the last year they have been inadvertently purged of sin for a while, but even then about all they were doing for that short period was to do what they ought to have been doing all along. Is that not so?

Mr. MELTZER. Well—

Mr. REUSS. The countries of Europe have generally increased their money supply in the last 10 years at a rate of 8, 9, or 10 percent a year, and they have increased their GNP at a similar rate.

We have increased ours at a rate of 1 or 2 percent of our money supply, and our GNP at about the same niggardly rate. Is that not the major fault of our policy, compounded along the edges by insufficient observation of what was happening as between demand deposits and cash and term deposits?

Mr. MELTZER. No, sir. I think that the problem really is the one that we are pointing to.

In order to control a process you have to understand it.

You have to know what are the basic elemental features that go into determining the money supply.

Otherwise, I do not see how you can hope to control it. Just as in the case of a corporation officer, he must know what is going on in his business in order to give instructions to other people so that they will know what to do. The problem that the Federal Reserve faces is that they really do not understand this process and, consequently, they think at times that they are being tight when, in fact, they are being easy and they think they are being easy when they are, in fact, being tight. They simply do not understand this process.

It is not that they have, I think, any desire to be restrictive when they should not be. The problem is that they do not understand what they are doing.

Mr. REUSS. Yes, but I am not interested so much in psychoanalyzing the Federal Reserve as I am in having a sensible monetary policy. And, in the past 10 years, in those instances, due to not knowing what they were doing, they created a more expansionary money supply than they thought they were creating.

Mr. MELTZER. Absolutely, at times this was true.

Mr. REUSS. This has been error, but it has been great for the country, has it not?

Mr. MELTZER. Yes, but we ought to be careful before we get too happy about such errors because they can reverse on us quickly.

There can be a change in the public's currency behavior, a change in the time deposit behavior, or any one of these other factors affecting the money supply and suddenly the money supply will decline.

In 1949—let me elaborate on that. In 1949 they consistently maintained that their policy was an antirecession policy, and yet the money supply was shrinking during the recession.

Now, why was the money supply shrinking during that period while the Federal Reserve was maintaining what they call a "posture of ease?"

The answer is that they did not understand what they were doing, and I think the same thing can happen now because I do not think their understanding has improved since then.

Mr. REUSS. Of course, one reason that the money supply could have been shrinking in 1949 when we were getting into a recession is that the monetary authorities can create money until it, figuratively speaking, runs out of the economy's ears, but if business expectations are bad or if the tax system or fiscal policy is wrong and nonexpansionary, monetary policy alone is not going to produce the required lift, and, therefore, businessmen are not going to go to banks and ask for loans and are not going to expand and buy inventory even though there is plenty of money around.

To that extent they are "pushing on a string."

Mr. MELTZER. No, we find no evidence to support that. The one period, and the period that gave rise to that metaphor was during Chairman Eccles tenure during the depression.

It was during the late 1930's that they kept arguing that they could not push on strings. But, in fact, it had nothing to do with pushing on strings.

It was their very inappropriate behavior that the chairman referred to at the opening of this meeting. They doubled the reserve requirements in 1936 and 1937. Mr. Goldenweiser's statement in 1941, published in *Banking Studies*, gives very adequate testimony to that.

They described the doubling of reserve requirements as no change in their policy. The fact that they had doubled reserve requirements seemed to them to make no difference. The reason for that is developed in some detail in our report. But the simple reason is that they did not understand the role of excess reserves in the banking system, and they did not understand what the effect of their operation would be. So they made an error and compounded it. And this is the most serious weakness in the system, that they do not understand the operation that they have been entrusted to control.

If I may add to that, I agree with your opening statement that it is not so much a matter of administrative arrangements as it is a question of their having a thorough understanding of the process that the Congress has given them to control.

And I just do not find very much evidence that they have that understanding.

Mr. REUSS. Well, I hope your study, Dr. Meltzer, will help me on the point with which I have the most difficulty which is: How do you sort out the effects of the monetary policy which the Federal Reserve does not now control because they fail to recognize them?

You mentioned two of those, namely, the interplay between demand deposits and time deposits and the interplay between demand deposits and currency.

How do you sort out the total effect of these monetary changes to which you say the Federal Reserve has been blind and the total effect of the changes in monetary policy to which the Federal Reserve has not been blind.

What is their quantitative measure? You certainly are not suggesting that the Federal Reserve has no effect on the money supply?

Mr. MELTZER. I would suggest—

Mr. REUSS. In many cases the results may be different from what they are trying to do, but it does affect them.

Mr. MELTZER. Let me try to answer that. That is a multipart question. Let me answer it in several stages.

First, the Federal Reserve certainly does affect the money supply. Their primary influence is exerted through the monetary base, bank reserves plus currency. Their policy actions change the base and thus change the money supply. Our theory tells us that a 1 percent change in the base should cause a 3 percent change in the money supply. That means that a dollar of new reserves or currency should add \$3 to the money supply. We have tested that and found that it holds for many different time periods.

Second, our theory incorporates factors like time deposit demand and currency demand by the public. It tells us what the effect of changes in the public's desire for currency or time deposits will do to the money supply. An exchange of currency for demand deposits should have a smaller effect on the money supply than an increase in bank reserves through open market operations. A switch of demand deposits into time deposits should have a smaller effect still, according to our theory.

Now, we have tested these implications. And we find that they generally hold. So we have confidence in the theory. We have evidence to support the theory. That is what gives us our confidence in it.

Our point is not that the Federal Reserve does not have any effect on the money supply. Their policy operations are of very great importance. But they do not understand how their policy operations affect the money supply. They do not have an adequate theory, and they have not developed and tested one.

That is why I say that they do not know what they are doing. Their theory is inadequate and has not been verified.

We have also tested our theory in France, in Great Britain and we have started to test and develop a theory for Canada. Generally the theory works quite well.

It is on the basis of these tests that we believe that we can sort out the effects of the various factors. We do not say that our theory is absolutely correct in every detail. What we are saying is that it is possible to analyze the factors determining the money supply and put them together in a coherent, consistent, and validated way. Then you can understand their effect and control them or at least do much better than has been done.

Nor do we claim that our theory is correct in every way and theirs is totally incorrect. All we say is that we have compared the two and have seen which one of the two is better.

Someone will come along with a better one than ours. Then control can improve further.

The CHAIRMAN. The Federal Reserve, of course, has the power to determine the volume of money. Has it not erred more times during the past 50 years by failing to provide sufficient money rather than by providing sufficient money or more than sufficient?

Mr. MELTZER. If we take the great wartime experiences, of course, the general policy has been on the side of being much too easy during wartime periods. Some Members of the Congress, I believe, and others were anxious to see a larger part of our war effort paid for by taxes. The Federal Reserve provided the money to finance that and overproduced money.

At other times I think—let me summarize my views on this by saying that they have gone too far at various times, in both directions, and it would be very difficult to conclude as to which times they did worse.

The CHAIRMAN. Doctor, some of the Members of the committee and the House are contemplating a campaign with the Members of the House of Representatives by organizing a Steering Committee, composed of all who are interested in it, to make sure that we do not increase the 4¼ percent interest rate ceiling on long term bonds.

Efforts have been made in the recent past to raise the ceiling, and a few of us have led the campaign against it, and at one time it almost passed before we knew about it.

But we succeeded in stopping it with a group of about 60 or 70 Members of the House.

Now, it occurs to me that all signs point to an effort to be made in the reasonably foreseeable future to take that 4¼ percent ceiling off.

Are you not impressed that there is something brewing in that direction?

Mr. MELTZER. I haven't been watching that, sir, in recent months.

The CHAIRMAN. Now, if we are going to peg the prices of those bonds, should we rely upon the traditional and well known method of raising the reserve requirements of banks in order to prevent an excess amount of money and credit, or should we have a different system, like immobilizing reserves in order to do it? Which would you suggest would be the better?

Mr. MELTZER. I would say that I am a strong partisan of open market operations. And I think the record bears out that the Federal Reserve has not fully understood the way in which reserve requirements fit into the System.

I am strongly in favor of seeing that power, the power to alter reserve requirements, taken away from them. That would force concentration on open market operations.

The CHAIRMAN. Now, would you have the open market operations conducted as they have been in the past almost as a secondary way, used, that is, after lowering reserve requirements as a measure of providing reserves for the commercial banks, or would you change the law or the regulations and make it possible for the Open Market Committee to acquire more bonds in their portfolio, and let the interest flow over into the Treasury?

Had you given that consideration?

Mr. MELTZER. Yes. I would see no harm in having the interest flow back into the Treasury.

The CHAIRMAN. It occurs to me that the Federal Reserve System could, without any danger of inflation or deteriorating the dollar, could, over a period of years—not quickly or suddenly—but finally fully acquire and own as much as, say, half of the national debt, which would be about \$150 billion. Naturally, that would have to be done slowly.

But when accomplished it would, of course, save the taxpayers about \$5 billion or more a year.

How would you look upon a proposal like that?

Mr. MELTZER. Well, I am in favor of saving the taxpayers' money. As far as the proposal—may I ask a question about the proposal, sir?

You would have the Federal Reserve buy up the debt, is that right?

The CHAIRMAN. Well, when other people don't want it, that is as the economy grows.

Mr. MELTZER. When it is appropriate, say, to increase the quantity of money, that they would do it through open market operations.

The CHAIRMAN. That is right.

Mr. MELTZER. Oh, absolutely. I think that open market operations should be their primary tool. One of the recommendations I would like to make is that the discount window be left open, and at a penalty rate, so that the banks can borrow and make their own reserve adjustments. That would remove a problem that has consistently plagued the Federal Reserve, and focused their attention on all of the shortrun money market changes. Such problems should be removed from the concern of the Open Market Committee. Instead of concentrating on the 3-week or 1-week period, or hourly or daily operation, the Federal Reserve Open Market Committee should be asked and forced, perhaps, to concentrate on the 6-month problem, or the 1-year problem, to provide the requisite growth in the money supply, and to leave these very shortrun problems to the bankers. And under those circumstances, I would want them to deal in open market operations exclusively.

The CHAIRMAN. Mr. Gordon, I would like to ask you this question: In 1960 and 1961 I believe is when you discovered in Canada that you did not actually have control of your Central Bank. Is that not right?

Mr. GORDON. The problem originally began, sir, in 1956-57. On that occasion, the Central Bank was pursuing a tight money policy. The Minister of Finance was questioned in the House concerning the policy, and he denied that he had anything to do with the policy, or was responsible for it.

Subsequent to these events, it became common for the Minister to deny on the one hand that he was responsible for the Bank, and the Bank to deny, on the other, that it was subservient to the Minister, which finally produced a crisis in the money market in 1959, and then was brought to a head by the insertion of the Governor into the field of public controversy in 1960-61.

Mr. WIDNALL. Mr. Chairman, would you yield at that point?

Wasn't that basically a clash of personalities, and not something wrong in the structure?

Mr. GORDON. Well, I believe, myself, sir, that a structure should always be designed to provide for the existence in positions of authority of inappropriate personalities.



The first Governor of the bank was a man of unimpeachable integrity and sense of the proper position of a public servant. The second Governor was not. But we cannot tell beforehand which personality will occupy the post.

Mr. WIDNALL. Does the Bank have to get annual appropriations to run its business?

Mr. GORDON. No; it does not. Indeed, it did not even furnish an operating statement until a few years ago.

The CHAIRMAN. But they do furnish operating statements now annually?

Mr. GORDON. They do. The statements are so restricted, however, that it is quite impossible for an outsider to analyze them as one would the operating statement of a business.

The CHAIRMAN. Now, from time to time various officials of the Fed have suggested that the independence of the Federal Reserve actually serves a good purpose, actually helps the Congress. The idea is that when something unpopular is done, something like tight money, we can say, "the Fed did it; we didn't do it." And they would be a sort of scapegoat, and we would be off the hook. It's supposed to be tempting, to us, to evade that responsibility.

But we would get ourselves in a position like you were in in Canada. The people would not know who to blame, they would not know—and, of course, they have no way of voting against the money managers, they have no way of reaching them, unless they are subservient to the elected officials there is no way for the people to reach them at all. And that is what you got into in Canada, wasn't it?

Mr. GORDON. Yes, sir. It was a situation which, of course, was not sustainable for very long.

But at one time during the history of it, the central bank inserted itself into an election campaign. Its annual report was published in the middle of an election campaign, and the report was deliberately written to influence the state of opinion.

The CHAIRMAN. Well, we had just in a minor way something like that in our country one time, when Mr. Eisenhower was wanting to get all the money he could to apply on the budget. The Fed came to his rescue by turning over \$266 million at one time at the end of the year—just out of the clear blue. And that is somewhat of a political gesture, it was thought at the time by the people. Of course other people did not take that view.

The argument is made in this country that the Fed should be insulated against the electorate—the political angle.

Isn't it true in most countries of the world the central banks are more or less tied in, their monetary policies, with the central government—the central bank with the central government? And that is for the obvious purpose of the people being able to blame somebody that they have something to do with putting into office. Isn't that correct?

Mr. GORDON. Yes, I believe this is the heart of the issue.

We mistake the question of responsibility very often. We think of the responsibility of a public official in terms of his personal integrity. However, responsibility really means being responsible to some other body and eventually to the people at large.

The CHAIRMAN. Yes.

The insincerity, I think—of course that is just my opinion—of the contentions of people that the central bank should be insulated against the electorate is due to the fact, not only that they have nobody to actually blame, but it is hurtful to the economy—in the case of our Federal Reserve System in particular—because although they are insulated and have the type independence they claim they are entitled to have and insist upon having, if they have that type independence, they are insulated against the people all right, and the people cannot reach them.

But they make no effort to insulate themselves against the bankers who profit the most by what they do.

It is rather almost on the side of hypocrisy, the way I view it, for us to say that there should be a small number of people to act as our monetary managers. The Constitution gives that power to the Congress. The Congress delegates it in this case to the Federal Reserve. And if we just let them run the show, independent of everybody, the people don't get the consideration.

But now they are not trying to insulate themselves against the bankers, not at all. The bankers are on the boards.

Now, Mr. Wilson, President of the United States when the Federal Reserve Act was passed, wanted 12 autonomous banks, just like were adopted in the 1913 act—no Central Bank at all. He was opposed to it.

Well, of course, the big bankers all fought it. They didn't like it at all. They wanted a central board, like the present Open Market Committee, where they could have a voice and help determine the volume of money and the cost of that money.

Well, Mr. Wilson said that was against the public interest. And when certain big bankers visited him one time, Mr. Glass insisted that he see them, because they insisted they knew more about money than anybody else, and they wanted to be on those boards.

And when they came in his office, and he was asked that question—"Mr. Wilson, we believe we know all about the monetary matters of our Nation, and we know more about it than the people in politics, and we want this Federal Reserve fixed so we can serve on these boards," Mr. Wilson said, "Which one of you gentlemen would ask me to put presidents of railroads on the Interstate Commerce Commission, to fix passenger rates and freight rates?" They didn't attempt to answer that. They began to talk about the weather, and they slunk out, and they didn't come back any more.

But Mr. Wilson went ahead with his insistence, and he got it fixed up just like it was.

Well, now, that was fine—no central bank, but just each region to look after the finances of that region—a wonderful theory.

And then in order to get eligible paper to create reserves, they had to make loans to little businessmen and farmers, and people like that locally. And they were pursuing that type of thing all the time because they wanted that eligible paper. They could put it in their bank and lend money. It was wonderful.

But they began to get away from that. Then they got the Open Market Committee and through that a central bank. And they are on these committees that Mr. Wilson didn't want to exist at all and certainly wouldn't have wanted them to be on.

I think it is almost on the side of hypocrisy for people to say they believe that we should do everything in the interests of all the people, equal rights to all and special privileges to none—and yet advocate that we have an independent board to determine our monetary policies, which is the most important policy any government on earth will ever be called upon to execute and administer—to let it be executed and administered by people who are selfishly interested. And that is what we are doing here.

They want an independent board, independent of the people, independent of those who are elected by the people, but not independent from those who would profit by their operations—but insist that they be allowed to serve on the board. That is the part that I think that our committee should give a lot of consideration to and endeavor to get something done that will be fair to everybody.

Have a board, have monetary managers—but who will not be catering to any particular group that is benefiting from the decisions of the operating managers. And that is what you have been trying to do in Canada, is it not, Mr. Gordon?

Mr. GORDON. Yes. We haven't done anything specific yet, Mr. Chairman, because a Royal Commission is now sitting. But it is expected that the Royal Commission will make proposals of this sort.

The CHAIRMAN. Yes, sir.

Any other questions, Mr. Widnall?

Mr. WIDNALL. Yes, I have some questions, Mr. Chairman.

The CHAIRMAN. All right.

Mr. WIDNALL. Dr. Meltzer, you have evidently made a very thorough study of the 50 years of the Federal Reserve System. You are not just highly critical of the last decade, but all five decades. And these have been under different Federal Reserve heads, different Federal Reserve boards.

Now, in your study, was it complete enough to tell and place in the record any criticism of lack of rapport between Government and the Federal Reserve System made by a President of the United States or a Secretary of the Treasury?

Mr. MELTZER. Let me answer that first by saying that we have gone into great detail about the postwar period. We have not gone into great detail about the earlier period, although we have studied it. Professor Friedman, who will be here, I think, later this week has gone into a study of periods before and after the Federal Reserve was chartered. He has done more detailed studies of the earlier years.

But I would say "Yes," there have been periods in which the Federal Reserve at least has claimed to us and I think publicly that it did operate by so-called leaning against the wind.

One of these, I believe, had to do with the rise in the discount rate in 1957, if I am not mistaken.

The CHAIRMAN. That was Mr. Martin's statement. We were in a recession, and I told him at the time that he was leaning against the wind of the people, but not leaning against the wind of the banks.

Mr. WIDNALL. As I recall that, Mr. Chairman, it was leaning against the economic wind, and not against the President or the Secretary of the Treasury or the Government. The essence of the main bill before us has to do with a complete revision of the System, emasculating what we have today and starting out prac-

tically anew. And, as I understand, the chief allegation that has been made is there is no real communication with Government, and that this is operating completely in a secret chamber, without any such communication, and independent decisions are made that are not in the interests of the people of the United States.

And I think it is extremely important for the record to have documented what Presidents of the United States in 50 years have criticized this, what Secretaries of the Treasury have criticized it, and what recommendations have been made to change it.

We have had Democrat and Republican Presidents. We have had many changes on the Federal Reserve Board.

I think it is extremely important when we are evaluating the 50 years.

Mr. MELTZER. May I give you one example that comes to mind? For the most part, we do not know what goes on in the detailed meetings of the Board of Governors, or the Open Market Committee. We do know a little bit now, perhaps more than we have before, because the diaries of President Harrison, former President of the New York Federal Reserve Bank, have now been deposited at Columbia University.

I understand that at one very critical juncture in monetary policy, and in the state of the economy, the Congress was—during the great depression—the Congress was clamoring for some Federal Reserve action. And I think Mr. Patman read and quoted President Hoover's statement to that effect. Yet during that period the Federal Reserve was doing very little.

Now, there was one very brief period in which they engaged in large scale open market operations. The Congress had been clamoring quite loudly, and Members of the Congress had been making statements which would lead many in the Federal Reserve to believe that there might be serious changes in the act. At that time, they had a meeting of the Open Market Committee at which they voted to have open market operations to expand reserves. They determined, in order to meet the criticism of Congress, that the managers could go out and buy these open market securities on the following day so that they would appear in the record of their actions for that week. And so that they could then say to the Congress—

Mr. WIDNALL. Isn't it true the Secretary of the Treasury was a member of the Board at that time as well as the Comptroller of the Currency?

Mr. MELTZER. Yes, that is correct. The Secretary and the Comptroller were both members of the Board at that time.

Mr. WIDNALL. The circumstances were different than they are today.

Mr. MELTZER. Different in what respect, sir?

Different in terms of the composition of the Board—perhaps yes. Different in terms of the fact that they did not really understand the nature of the events that were occurring and the correct or appropriate responses to them—I would say by and large I see no evidence to conclude that things are different in that respect.

Mr. WIDNALL. At that time, the Federal Reserve System and Board was much closer to the Government than it is now; isn't that so?

Mr. MELTZER. I am not sure "closer." You mean by the presence of these two gentlemen?

Mr. WIDNALL. I think this can be documented, as to the complexion of the Board.

Mr. MELTZER. That the Secretary of the Treasury and the Comptroller were members of the Board. That is certainly true in that sense the Government's policy—

Mr. WIDNALL. You said there was a great clamor in Congress then for change.

Mr. MELTZER. Yes, sir; that is my understanding of the record of the Harrison diaries.

Mr. WIDNALL. I would like to ask another question.

You are rather critical of the policy in that early 1930 period. Now, in 1935 and 1936, what was our situation with respect to other countries with respect to gold and currency flow?

Mr. MELTZER. You mean were we experiencing an inflow in 1935?

Mr. WIDNALL. In 1935 and 1936.

Mr. MELTZER. I am not sure of the precise dates.

But during that—somewhere in that period, we were experiencing a substantial inflow of gold—what I suppose we can refer to as saber-rattling gold because of events in Europe.

Mr. WIDNALL. Don't you feel that defensive measures had to be taken at that time?

Mr. MELTZER. No, sir; I did not believe that defensive measures had to be taken. And certainly I could not find myself in any sense supporting measures such as doubling reserve requirements. That is a very drastic action in the midst of a depression.

Mr. WIDNALL. Well, it is certainly necessary to increase reserves when you are experiencing that type of flow.

Mr. MELTZER. At times. If we read Mr. Goldenweiser's statement, which is perhaps much more knowledgeable than mine about the reason for doing this, the Federal Reserve did not take that action as a device for tightening the money supply. At least that is his statement. He was the director of their division of research and their adviser. He said, "We did not envisage that as any major change in our policy of ease. We did that because we were out of touch with the market," I think that was his phrase.

Mr. WIDNALL. Now currently, isn't Switzerland putting the brakes on their money supply, despite unemployment in Switzerland?

Mr. MELTZER. I have not studied the current Swiss situation.

Mr. WIDNALL. Germany is, also.

Mr. MELTZER. Germany is attempting to control, yes. I do know a little bit about that. Germany is attempting to control the rate of price increases.

Mr. WIDNALL. Isn't a lot of that due to the influx of funds from abroad, which is exerting pressures on prices and starting inflation?

Mr. MELTZER. I think my own analysis of the German situation would take as a very important factor the decline in the number of workers that they have been able to recruit from places like East Germany. That has put pressure on wages and prices in West Germany, and has let to a more rapid rate of price increase. Prior to the building of the wall, they were able to expand their economy by attracting workers from East Germany, without putting a great deal of pressure on prices.

Mr. WIDNALL. So you feel the funds coming in from abroad to Germany and Switzerland exert no pressures?

Mr. MELTZER. No. Gold flowing into the country has an expansive effect on the money supply.

Mr. KILBURN. I was much interested in your first question which I understand has not been answered.

I presume the professor here has made a study of the Federal Reserve for 50 years.

Have you ever known of a President or a Secretary of the Treasury that has criticized the operations of the Federal Reserve System?

Mr. MELTZER. Yes. I think President Hoover—President Hoover's statement was that the Federal Reserve—in periods of great crisis the Federal Reserve was a weak reed. That is a paraphrase.

Mr. KILBURN. Will you please put it in the record?

Mr. MELTZER. Certainly.

(The quotation appears on p. 212 of Hoover's "Memoirs.")

The CHAIRMAN. Didn't Mr. Truman—Mr. Truman criticized the Federal Reserve Board—he had the whole Board come to see him. It never happened before. Not only the Board, but the Open Market Committee members.

And isn't it a fact, Doctor, that the Federal Reserve's operations had not been as important—were not important until, you might say, after the commencement of World War II. The national debt was small before that time, comparatively small. Its operations were in proportion. Isn't that correct?

Mr. MELTZER. In terms of the value of their purchases or sales, yes. In terms of their impact, sir, no.

Their behavior—again, to return to the period 1931, 1932, 1933—was very, very significant from the standpoint of converting what at least in my judgment and the judgment of other experts—not all other experts, I might add—might have been a minor recession into a major depression.

Their action in 1936 and 1937 was largely responsible for the recession that occurred in 1937, 1938, in my judgment.

The CHAIRMAN. Now, the early 1920's—that was a time when the Federal Reserve did not rise to the occasion, and actually caused things to be done that were disastrous to the economy. Is that correct?

Mr. MELTZER. That is correct. In the period 1920, 1921, that recession was largely a Federal Reserve recession.

Mr. WIDNALL. Mr. Gordon, in June of 1962, there was a crisis in Canada, and the United States came to the rescue at that time. Do you believe that the deliberations within the United States at that time, the decisions that were made, should be exposed to public view word for word?

Mr. GORDON. That is a very difficult question, Mr. Widnall.

Mr. WIDNALL. This committee is asking right now the Federal Reserve System, the Open Market Committee, produce the minutes of all of their meetings, so that they can be evaluated by the committee. We just know from experience once they are here, everybody in the United States is going to know, and everybody in the world. There is some disposition on the part of some of us to say that many of these transactions are transactions that could be harmful in our relations with other nations if they are exposed to public view.

Mr. GORDON. Well, I would say that, let us say, a year after the event, more harm is likely to come from permitting groundless speculation as to the nature of the agreements that were made, because it is the responsibility of independent economists, for example, to analyze the circumstances. In the absence of hard information they must speculate. And more harm is likely to come from permitting groundless speculation than by disclosing.

I thought when you asked the question you had in mind immediate disclosure of the agreements.

Mr. WIDNALL. Well, we have asked for the minutes for 1960, 1961, 1962 and 1963. And 1963 would certainly be the same as immediate disclosure.

Mr. GORDON. I would think that the monetary authorities should have some right to hold information for as much as 6 months, or perhaps a year, and probably it would have to be at their discretion which to hold, because some information might be damaging to an on-going program.

But I do not think that information held more than a year is really justified.

Mr. WIDNALL. Is there any means of public information in Canada as to the deliberations within the central bank with respect to the monetary policy?

Mr. GORDON. None.

Mr. WIDNALL. Do you know of the release of public information in any of the other central banks—deliberations between members with respect to decisions on interest rates and exchange with other countries?

Mr. GORDON. I believe, as a matter of fact, that the United States furnishes more information of this sort than any other central bank in the world. I may be wrong in that there may be a particular small central bank which furnishes more, but certainly the Federal Reserve furnishes more than any other major central bank at the moment.

Mr. WIDNALL. Mr. Gordon, I don't really want to put you on the spot. You are a foreign visitor. But you are a witness before this committee.

Would you care to express an opinion as to whether or not you believe the Federal Reserve System knows what it is doing?

Dr. Meltzer evidently doesn't believe it does.

Mr. GORDON. Well, as a foreigner, I read statements that are made in the press from time to time by officials of the Federal Reserve, such as the Chairman of the Board of Governors. And to speak frankly, I am not surprised at the bad record of the Federal Reserve because I could not imagine that a good record could emerge from the place from which such statements emerged—if I am making myself clear. That is to say, it seems to me that there is so much muddiness in the analysis of monetary processes displayed by the public statements that it is very difficult to believe that the actual practice could somehow resolve itself and be clearer.

Now, I must say that our own central bank in Canada is no less muddy in its public statements than the Federal Reserve has been. And I would ascribe a good deal of our bad performance to exactly the same sources as Professor Meltzer has. In fact, I wonder at

times whether we are not experiencing a North American phenomenon, rather than a peculiarly Canadian or American one, since there seems to be an extraordinary disposition in the two countries in northern North America to make the same mistakes.

But I just add that this is the result, not of the intensive analysis such as Professor Meltzer has done, but of the layman's reading of press reports concerning monetary events in the United States.

Mr. WIDNALL. Well, you have just testified on H.R. 9631, which would enable a great change in the composition of the Federal Reserve Board.

Do you believe that putting on that Board a lot of uninformed people for a very short term is going to give you a better system than you have right now.

Mr. GORDON. No, I do not, sir. The part of Professor Meltzer's testimony that would worry me is that it seemed to me to be largely an argument that the quality of the work was poor, and, therefore, should be replaced by better work. And this does not necessarily call for a reorganization of the System. It calls for a replacement of personnel, perhaps.

Now, as I read the bill, if it was taken literally, it would produce a very short-term Board, which is not likely to result in an improvement in the technical work which the Board would perform. But I think that if one reads the bill with some idea as to what would evolve from it, I take it to mean that what would evolve from it is that it would in fact be the Treasury that was the monetary authority in the United States.

Now, again, this is based on very little knowledge of the way the American system of government works.

But I cannot conceive that a very short term Board of the sort that is proposed in the bill would actually end up being the important operating agency of monetary policy.

Mr. WIDNALL. Mr. Gordon, in other words, what you are saying is that the Treasury would dominate under the new bill.

Mr. GORDON. Yes, sir.

Mr. WIDNALL. Now, I believe you are familiar with the fact that there is a rapport between the Federal Reserve System and the National Security Council, the President's Economic Committee, and the Treasury at the present time, an exchange of information all the time.

Mr. GORDON. Yes.

Mr. WIDNALL. So that actually in practice here, we are doing better than the central bank of Canada with respect to rapport with the Government.

Mr. GORDON. Yes, sir.

Mr. WIDNALL. Do you know enough about the other central banks in the world to know how our present setup or rapport would compare with those—say the Bank of England?

Mr. GORDON. I would judge that if we were to rank central banks in a spectrum, running from those which in fact had very close relations with their governments to those who had very distant and arm's-length relations with their governments, we would have to rank the United States on the latter side, as I expressed it just now—that is, by and large, among those that had rather distant relations with their governments.



Mr. WIDNALL. I think that is all.

Thank you both.

The CHAIRMAN. Thank you, gentlemen, very much, for your appearance and your testimony.

Will it be satisfactory if any members of the committee—some could not be here this morning—would send you a question through the chairman in writing, and you will be willing to answer it when you look over your transcript?

You will probably have some questions—not many—that way.

We were intending to have these other witnesses this week, but on account of the fact that the members will be out of town, we are canceling the hearings on Thursday and Friday, and we will resume again after the week of the 17th. That will be the 24th.

And so, without objection, we will stand in recess subject to the call of the Chair.

Again, thank you, gentlemen.

(Whereupon, at 11:55 a.m., the committee recessed, subject to the call of the Chair.)

# THE FEDERAL RESERVE SYSTEM AFTER 50 YEARS

---

TUESDAY, FEBRUARY 25, 1964

HOUSE OF REPRESENTATIVES,  
SUBCOMMITTEE ON DOMESTIC FINANCE OF THE  
COMMITTEE ON BANKING AND CURRENCY,  
*Washington, D.C.*

The subcommittee met, pursuant to call, at 10 a.m., in room 1301, Longworth House Office Building, Hon. Wright Patman (chairman) presiding.

Present: Representatives Patman, Reuss, Hanna, Kilburn, Widnall, and Brock.

The CHAIRMAN. The committee will please come to order.

Today we resume hearings on the first 50 years of the Federal Reserve.

This week we will hear from six outstanding economists. Every one of these men is a recognized authority on monetary economics. They represent universities from California to Cambridge, Mass. I am sure that by the time they have finished presenting their testimony and answering our questions we will have heard many shades of opinion and points of view.

We have not stacked the deck. We have tried to get the broadest possible range of opinion on how our monetary system operates, on the effectiveness of monetary policy, and on the independence of the Federal Reserve.

During the first 2 weeks in March we will hear from still more economists and from Government witnesses including Secretary Dillon.

Now, this morning we have Prof. Harry Johnson and Prof. Henry Villard.

You gentlemen have prepared statements, I believe. They have been furnished to the members of the committee, and we appreciate them, gentlemen.

Now, if it is all right, each one of you may summarize your statements any way that you would like to so as to use the minimum time to present the main points, and then the members of the committee will interrogate you and probably bring out everything you desire to anyway. We are indebted to you gentlemen for coming here this morning. Professor Johnson, you may proceed, sir.

**STATEMENT OF PROF. HARRY G. JOHNSON, UNIVERSITY OF  
CHICAGO, CHICAGO, ILL.**

Mr. JOHNSON. Thank you, Mr. Chairman. I want to begin with the argument for an independent monetary authority which is, I think, the key——

The CHAIRMAN. Will you identify yourself, please, for the record first?

Mr. JOHNSON. I am Prof. Harry Johnson, of the University of Chicago.

I want to begin with the argument for an independent monetary authority, which is the crux of the issues facing the committee, in my judgment.

The argument for an independent monetary authority has two facets to it. One is the political argument that an independent monetary authority is desirable to prevent Government from being able to indulge in its natural propensity to resort to inflation. The other, which is less explicitly political, is that a stable monetary environment is essential to the proper functioning of a predominantly free enterprise society, and that an independent monetary authority is essential to maintain such a monetary environment.

The first argument seems to me utterly unacceptable in a democratic country. Indirectly, it is an argument for establishing the monetary authority as a fourth branch of the Constitution, charged with the function of forcing the Legislature and the Executive to follow conservative economic policies involving the balancing of the budget and restraint on Government expenditures. In other words, it involves the establishment of a special position in Government for the owners of one form of property—owners of money and of assets fixed in terms of money—a position which is inconsistent with the principles of democratic equality and the presumption of democracy that the purpose of government is to serve the social good.

Turning to the second argument, granted that a stable monetary environment is desirable, the question arises whether an independent monetary authority as presently understood is sufficient to provide such stability. The argument that it is assumes that, if free of control by the Executive and Legislature, the monetary authority will govern monetary policy in the light of the longrun best interests of the economy, and will conduct its policy flexibility and efficiency in the short run. This assumption is not consistent with the historical evidence of the behavior of monetary authorities; the evidence is rather that central banks have done little if anything to restrain inflationary policies in wartime—and war and its aftermath have been the almost exclusive source of serious inflation in the major countries in the 20th century—while in peacetime they have displayed a pronounced tendency to allow deflationary policies on the average. Moreover—I refer here particularly to the behavior of the United States and Canadian central banks in the past decade—in the short-run conduct of policy they have tended to overreact to changes in the economy and to reverse their policy with a substantial delay, thereby contributing to the economic instability that their policies are intended to combat.

These defects are in my judgment inherent in the conception, constitution, and operating responsibilities and methods of an independ-

ent monetary authority, and are unlikely to be modified greatly by gradual improvement of the techniques of central banking on the basis of accumulated experience and research. For one thing, freedom of a central bank from direct political control does not suffice to render it insensitive to contemporary political opinion. On the contrary, its position as the one agency of economy policy formation outside the normal political structure both exposes it to subtle and sustained political pressures and forces it to become a political animal on its own behalf, devoting considerable effort either to justifying its policies by reference to popularity-esteemed objectives or to denying responsibility for economic conditions and passing the buck on to the Executive or the Legislature, the result being to obfuscate the policy choices that have to be made. Secondly, the position of the central bank as controller of the money supply inevitably must bias the monetary authority—except in times of national emergency such as war—toward emphasizing the pursuit of objectives connected with the value of money—resistance to domestic inflation, and preservation of the international value of the currency—to the underemphasis or neglect of other objectives such as high employment and economic growth. Thirdly, the methods of monetary management, which involve the central bank concentrating its attention on money market conditions and interest rates, and on member bank reserve positions and lending, rather than on the performance of the economy in general, are extremely conducive to the behavior pattern of overreaction and delayed correction of error already mentioned.

Because it concentrates on money market and banking phenomena, rather than the effects of its policies on the quantity of money and economic activity, and because the effect of monetary policy on the economy operates with a substantial lag, the central bank is extremely likely to push its policy too far and too fast before it realizes that the policy has taken effect and begins to consider moderating it; and because the realization of effectiveness comes late, it is likely to reverse its policy too sharply. In addition, the fact that the central bank stands in a special relation to its Government and domestic economy fosters the existence of an international fellow club member relationship among central banks, a relationship congenial to the formation and propagation of policy fads in central banking. It is only on the basis of fads in central banking opinion, I believe, that one can understand the emergence of the fear of runaway inflation as a dominant motif in central bank policy statements in 1957–58 and the belief at that time in the need to reduce bank liquidity by debt-funding, or the widespread belief that the dollar would soon be devalued that emerged in 1958–59 and persisted thereafter in spite of reiterated statement of the U.S. determination not to devalue.

Recognition of the undemocratic nature of the political argument for an independent monetary authority, together with scholarly documentation of the inadequacies of the historical performance of the Federal Reserve System, has led a number of economists—including my distinguished colleague, Milton Friedman, who will appear before this committee at a later date—to recommend that the goal of providing a stable monetary environment should be implemented, not by entrusting discretionary monetary management to an independent

monetary authority, but by legislating that the monetary agency be required to increase the quantity of money at a fixed rate determined from historical experience. I have a certain sympathy with this recommendation, as an alternative to discretionary management as it has been conducted in the past, but there are, in my opinion, some overriding objections to it. In the first place, the proposal is essentially a component of a much broader program for transforming the country into a working model of an ideal competitive system, which system it is assumed would require no deliberate economic management; since the majority of public opinion seems in fact committed to the belief that economic management can improve on unfettered competition, adoption of the proposal would entail accepting a self-denying ordinance in a crucial area of policy, an inconsistency which I doubt would prove acceptable for long. In the second place, the proposal depends on the empirical assumption that the demand for money depends primarily on income and is relatively insensitive to changes in interest rates, an assumed fact concerning which the results of empirical research are in substantial conflict; if the demand for money is not a stable function of income only, the proposal might lead to more instability than discretionary management. Thirdly, the proposal abstracts from the complications of international competition. To be feasible, the proposal would have to be accompanied by the adoption of floating exchange rates, and even in that case might aggravate instability associated with international movements of capital in response to interest-rate differentials between countries; alternatively, it would have to be accompanied by policies of direct intervention in international trade and payments inconsistent with the efficient operation of a competitive economy.

My own view is that the pursuit of monetary stability through the separation of monetary management from other economic policy, and its placement under either an independent authority or a strict rule of increase, is an illusory solution to the problem. Instead, I believe that monetary policy should be brought under the control of the Executive and legislature in the same way as other aspects of economic policy, with the administration bearing the ultimate responsibility for monetary policy as part of economic policy in general. In making this recommendation, I must admit that there is a danger of monetary mismanagement in the pursuit of political objectives; but I consider it preferable for such mismanagement to be a clear responsibility of the administration, and accountable to the electorate.

I would also point to a danger emphasized by the British economist, Sir Roy Harrod, at the time of the nationalization of the Bank of England, and confirmed, in my judgment, to some extent by subsequent British experience; namely, that bringing the monetary authority within the fold of Government may give more rather than less weight in policymaking to its definitions of, and opinions on, policy problems. In this connection, though, I would like to point out that the monetary authority can only too easily be cast as a scapegoat to conceal the unwillingness of public opinion and the administration to recognize and resolve genuine policy conflicts. In particular, in

this country in recent years the fundamental policy problem has been the conflict between equilibrium in the balance of payments and a satisfactory level of domestic activity, imposed by the overvaluation of the dollar relative to the major European currencies; and I do not believe that an administration armed with complete control of monetary policy, but committed to preserving the international value of the dollar, would have conducted a monetary policy very different from what the Federal Reserve has in fact conducted. It might, of course, have taken the bold step of raising foreign loans on the order of \$15 to \$25 billion to tide over the years of waiting for European prices to inflate up to the American level, but there is no evidence that the administration has been prepared to contemplate such a policy. Given the commitment to a fixed exchange rate, domestic monetary policy must necessarily be subordinated to the balance-of-payments position; the burden of achieving a satisfactory level of employment and activity must be borne by fiscal policy rather than monetary policy, which, in recent circumstances, has meant a substantial tax cut; and it is the reluctance of public opinion, the Congress, and the administration to resort to a tax cut, rather than the policy of the Federal Reserve System, that is ultimately responsible for the unsatisfactory levels of employment and activity that have characterized the economy during the recent years.

While I believe that the monetary authority should be made part of the regular machinery of governmental economic policy making and policy execution, I am not too hopeful about the possibility that this change would result in a significant improvement in the efficiency of monetary policy as an instrument of shortrun economic stabilization. My reasons for skepticism stem from the analysis of the influence of the monetary authority's position and responsibilities in the economy on its methods of conducting monetary policy that I have already sketched. This analysis leads me to a conclusion basically similar to that of the proponents of a fixed rule of monetary expansion: that the monetary policy instrument is not well adapted to the pursuit of shortrun stabilization policy, and that it should instead be devoted, so far as possible, to the goal of providing a stable longrun monetary environment. I differ from the advocates of an expansion rule, however, in recommending that this goal should be established as a priority objective of discretionary monetary policy, operating as one of a group of instruments of economic policy rather than legislated as a rigid obligation on the monetary authority. I have developed the analysis underlying this recommendation in a lengthy document prepared for the Canadian Royal Commission on Banking and Finance, which is attached to this statement.

The CHAIRMAN. It may be inserted in the record at this point.

(The document referred to follows:)



ESSAYS IN INTERNATIONAL FINANCE

No. 44, November 1963

---

ALTERNATIVE GUIDING PRINCIPLES  
FOR THE USE OF  
MONETARY POLICY

---

HARRY G. JOHNSON



INTERNATIONAL FINANCE SECTION

DEPARTMENT OF ECONOMICS

PRINCETON UNIVERSITY

Princeton, New Jersey

975



*This is the forty-fourth in the series* ESSAYS IN INTERNATIONAL FINANCE *published from time to time by the International Finance Section of the Department of Economics in Princeton University.*

*This essay is based on a Staff Paper prepared for the Canadian Royal Commission on Banking and Finance in October 1962, and is published in this series with the permission of the Royal Commission. Permission to publish in no way implies that the Commission agrees with any or all of the views expressed. The International Finance Section has previously published, as ESSAY No. 42, the Memorandum submitted to the Royal Commission by the late Sir Dennis Robertson, with a foreword containing a description of the mandate of the Royal Commission and of the project of this Section to publish some of the Memoranda of Evidence. The Memorandum submitted by Dr. Marius Wilhelm Holtrop was published as ESSAY No. 43. The present essay is here published with only a few minor revisions of the original paper.*

*The author, Harry G. Johnson, was formerly Professor of Economic Theory at the University of Manchester and is now Professor of Economics at the University of Chicago and Editor of the JOURNAL OF POLITICAL ECONOMY. He has written several important books, perhaps the best-known being INTERNATIONAL TRADE AND ECONOMIC GROWTH and MONEY, TRADE, AND ECONOMIC GROWTH.*

*The Section sponsors the essays in this series but takes no further responsibility for the opinions expressed in them. The writers are free to develop their topics as they will. Their ideas may or may not be shared by the editorial committee of the Section or the members of the Department.*

*The submission of manuscripts for this series is welcomed.*

FRITZ MACHLUP, *Director*  
*International Finance Section*

ESSAYS IN INTERNATIONAL FINANCE

No. 44, November 1963

---

ALTERNATIVE GUIDING PRINCIPLES  
FOR THE USE OF  
MONETARY POLICY

---

HARRY G. JOHNSON



INTERNATIONAL FINANCE SECTION

DEPARTMENT OF ECONOMICS

PRINCETON UNIVERSITY

Princeton, New Jersey

# ALTERNATIVE GUIDING PRINCIPLES FOR THE USE OF MONETARY POLICY

## *Introduction*

This paper is directed to the specific question: what should monetary policy seek to do in the Canadian economy?

Monetary policy as traditionally conceived is concerned with short-run economic stabilization, the damping of the business cycle. This function has come to be expressed customarily in terms of the pursuit of the two objectives of price stability and high employment. Insofar as prices and general economic activity tend to move upwards or downwards together, these two objectives do not conflict, but are essentially the same: a monetary policy directed at stabilizing either one of the price level or the level of unemployment would tend to stabilize both. The two objectives may, however, conflict if the level of unemployment considered desirable itself implies a rising trend of prices, or if the price level is rising for some reason other than an excessively low level of unemployment.\* In recent years a third objective has been added to the list, the objective of economic growth; but for reasons that are too complex to be developed here, the objective of growth can in practice also be identified with the general goal of economic stabilization.\*\*

In addition to the general objective of economic stabilization, expressed in the three goals of high employment, price stability, and economic growth, monetary policy has in practice another objective, resulting from the role of the central bank as fiscal agent for the government, the objective of assisting the government to borrow in the financial markets on the most advantageous terms obtainable. This objective, which becomes paramount in wartime, may conflict and in the past has in fact seriously conflicted with the use of monetary control for pur-

\* This statement is phrased to avoid a final judgment on the issue of cost-push versus demand-pull inflation, and also to allow for the influence, important in Canada, of foreign price trends on the trend of domestic prices.

\*\* This is not to say that a government pursuing the objective of growth would necessarily conduct monetary policy on traditional lines; rather, the point is that the scope for monetary policy alone to stimulate growth seems limited to whatever contribution economic stabilization can make to growth. This point is implicit in the rather unsatisfying discussion of objectives contained in the Report of the Commission on Money and Credit.

poses of economic stabilization. The problems raised by the conflict between the objectives of economic stabilization and cheap governmental financing, however, were most acute in the period before that with which the Commission is immediately concerned, and will accordingly be ignored for the most part in this paper.

More generally, this paper will ignore the possibilities of conflict between the objectives of monetary policy, important as they are to both the explanation of past policy and the formulation of future policy, and will instead be concerned with the use of monetary policy for the purpose of economic stabilization, defined in the very broad sense of damping cyclical fluctuations in the economy. The starting point of the argument is the assumption, presumed to be generally accepted, that the performance of monetary policy as an instrument for short-run economic stabilization in Canada in recent years has been definitely unsatisfactory.

It is not the purpose of this paper, however, to attempt to assign responsibility for the unsatisfactory record of Canadian economic policy with respect to economic stabilization in recent years. Instead, its purpose is to examine the merits and drawbacks of the alternative lines of action with respect to the guiding principles of future monetary policy that might be pursued by the Commission, in the light of the unsatisfactoriness of recent experience. For this purpose, it is sufficient to assume that the unsatisfactory record is the outcome of a combination of causal factors, which may include confusion in the minds of the government and the public with respect to the priorities of policy, insufficient coordination between the government and the Bank of Canada, errors on the part of the management of the Bank, and inadequate knowledge of the powers and limitations of monetary control of the economy on the part of all concerned.

Given the unsatisfactory nature of the record of the past, there are three main alternative positions that can be taken as to the conduct of monetary policy in the future. The first is to accept the record of the past as establishing that in practice monetary policy cannot achieve the degree of economic stabilization that has been expected of it, and to recommend that this fact be recognized by a corresponding writing-down of the standards for monetary performance to make them accord with what is achievable by monetary policy as operated in the past. The second is to take the record of the past as establishing that the performance of monetary policy with respect to economic stabilization could be improved by eliminating sources of error, and to recommend changes in the philosophy, institutional setting, and methods of monetary management that would help to improve performance. The third alternative

is to take the record of the past as establishing that monetary policy should not be entrusted with major responsibility for short-run economic stabilization, but should instead be directed to providing a stable long-run monetary environment, the responsibility for short-run stabilization being transferred to other instruments of economic policy. Broadly speaking, the second alternative corresponds to the approach of the American Commission on Money and Credit, and the third to the approach of the British Radcliffe Committee.

The main part of this paper is devoted to discussion of the arguments for and against these three approaches, and exploration of their implications for the reform of the Canadian monetary system. As a prerequisite to examination of these approaches, however, it is necessary to make explicit certain assumptions about the nature of central banking, the way in which monetary policy operates, and the philosophy of economic policy, since these assumptions are important to the argument. In addition, it is relevant to point out that the arguments concerning the various alternatives depend crucially on whether it is assumed that the country is on a fixed exchange rate or a floating rate, since the choice of a fixed-rate system imposes definite limitations on the freedom to use monetary policy for economic stabilization. Finally, whatever the approach adopted, it is necessary to consider the merits of various suggestions that have been made to give the monetary authority special powers of selective control over certain types of credit or certain kinds of credit institutions that are considered to play an especially destabilizing role in economic fluctuations. Accordingly, the paper begins with a statement of fundamental assumptions, goes on to comment on the relevance of the choice between fixed and floating exchange rates, discusses the three alternative approaches to future monetary policy, considers the case for and against various specific types of selective controls, and concludes with a summary section containing the author's personal judgments on some of the major issues.

### *Fundamental Assumptions*

In order to discuss alternative approaches to the future conduct of monetary policy in a practically relevant way, it is necessary to take a position on three fundamental matters, all of which can be considered "practical" questions, though in different ways. These matters are the nature of a central bank as an institution, the way in which monetary policy affects the economy, and the philosophy of economic policy.

The importance of the institutional nature of a central bank derives from the fact that monetary policy is entrusted to its day-to-day man-

agement and influenced by its advice, rather than being managed directly by the government as an integral part of its general economic policy. The central bank is an independent corporation, not a government department; its personnel is selected by a different procedure than the Civil Service; and its routine activities bring it into intimate contact with one special sector of the economy, the financial system. It is only to be expected, therefore, that it will develop its own views on monetary policy, views that will be influenced in general by the habits of thinking about economic affairs prevalent in the financial community, especially by that community's concepts of "soundness" and of "financial morality," and in particular by the financial community's assessments of the nature of contemporary national economic problems and the policies appropriate to deal with them, whether these assessments are grounded in thorough economic analysis or not. Further, since the central bank is a national institution part of whose work brings it into contact with its opposite numbers in other countries, the central bank's thinking on domestic policy problems will be influenced by the thinking of other central banks about their own and its policy problems. Finally, since the central bank in its day-to-day operations must establish and maintain working relationships with the financial system of the country, and since its effectiveness depends on its ability to manipulate that system, it will naturally seek to conduct its operations so as to avoid disrupting the functioning of the financial system.

In these respects, the central bank is not of course uniquely differentiated from government departments; departments of labor and agriculture, in particular, typically share the attitudes of their clients and in part serve to represent the interests of those clients to the government. The difference, however, lies in the fact that the central bank is at least partially independent, and is entrusted to formulate and carry out national policies that may be in direct conflict with the interests of the financial institutions with which it is normally in close contact.

The institutional nature of the central bank imposes two important limitations on the possibilities for improvement of the conduct of monetary policy, so long as monetary policy is entrusted to the management of a quasi-independent central bank. In the first place, there are narrow limits on the extent to which a central bank can be converted into an institution that controls the monetary system according to principles and methods of analysis that are radically different from those understood and accepted by the financial community. Secondly, the central bank itself will inevitably generate strong resistances to the pursuit of a monetary policy that threatens to disrupt established financial rela-

tionships or expectations.\* In short, if monetary policy continues to be entrusted to the management of a central bank—an assumption that is axiomatic—this itself imposes limits both on how far and in what ways the management of monetary policy can be improved, and on how vigorous monetary policy can be made to be. Recognition of these limits, however, may lead to any one of the three alternatives previously mentioned: it may be argued that, given the institutional character of a central bank, one should not expect monetary policy to achieve a very high standard of economic stabilization; or that there is still a wide gap between the attainable and the attained, that could be significantly narrowed by feasible changes in central-bank management and operating procedures; or that the central bank could contribute more efficiently to the prosperity and growth of the economy if it were relieved of the responsibility for short-run economic stabilization.

To discuss alternative approaches to the conduct of monetary policy fruitfully, it is necessary to take a position not only on what can reasonably be expected of a central bank, but also on what monetary control can be expected to achieve. This necessitates a general view of how monetary policy affects the economy. The view that seems to emerge from the research and thinking underlying the *Reports* of the Radcliffe Committee and the Commission on Money and Credit can be summarized very broadly as follows. Monetary policy has a direct and observable influence on interest rates and credit conditions, and through changes in these variables has an observable effect on the flows of credit through certain markets, and notably on the volume of bank loans and on the demand for mortgage financing of new residential construction. But what matters for short-run economic stabilization is not control over interest rates and credit conditions, or even over the volume of particular types of lending, but control over the volume of expenditures. And except in the case of housing, where the situation is complicated by the large-scale intervention of the government as a guarantor of mortgages the terms of which make their attractiveness to institutional lenders vary countercyclically, it is virtually impossible to establish that monetary policy has a reliable, speedy, and quantitatively significant influence on final expenditure.

This difficulty has led some experts to conclude that monetary policy has no influence on the economy. On the other hand, the weight of

\* Cf. Bank of Canada Submission II, §E, "Some Practical Considerations in Monetary Policy." This section amounts to the assertion that it is better to endure economic fluctuations than to counter them by a monetary policy that disturbs the financial system.

economic theorizing suggests that monetary policy ought to have some influence on economic activity; fragmentary evidence of such influence exists; and various well-known dramatic historical episodes testify that the influence of monetary factors can be significant, at least over the long run. Caution would therefore suggest the view that monetary policy does have an influence on economic activity, but that this influence varies with circumstances, with respect to both its magnitude and the time required for it to take effect. This view in turn suggests that the use of monetary policy for short-run stabilization is a difficult and hazardous enterprise.

This position, again, does not prejudge the issue between the three alternative approaches to the future conduct of policy. It can be argued with equal freedom that the central bank has done as well as could be expected, given the inherent difficulties of the task, and that there is no obvious way of improving its performance; or that the difficulties are a challenge to be overcome by more determined effort, requiring reform of the central bank to equip it better for an assault on the problems; or that the difficulties and risks of error are so great that the central bank would be better occupied with more modest responsibilities.

Finally, discussion of the alternatives requires a position to be taken on the general philosophy of control in a predominantly free-enterprise economy. Much of the discussion of monetary policy in the postwar period, and especially of "selective" techniques of control extending beyond the traditional "general" instruments of bank rate and open-market operations, has been concerned with questions of equity and consistency with the basic principles of a free-enterprise economy.\* The position taken in this paper is the pragmatic one that the use of monetary policy, or for that matter any other "general" policy instrument, for the purpose of economic stabilization necessarily involves frustrating the plans of some sectors or individuals in the economy for the general good, and that in the economic world as it is this necessarily involves some inequity. Accordingly, the decision as to whether to supplement or substitute for traditional monetary policy by more selective methods of credit control should be taken on a balance of considerations of equity and effectiveness, rather than by reference to the pure principles of a competitive economy.

\* These questions have even been raised with regard to the traditional instruments; in the United States it has been argued that control of the rediscounting privilege gives the central bank an undesirable degree of arbitrary authority; and both there and elsewhere the advocacy of "bills only" in open-market operations has been fundamentally a demand for fair competitive conditions for government-bond dealers.



*The Relevance of the Exchange-Rate System*

As previously mentioned, it makes a considerable difference to the argument concerning the three alternative approaches to the future conduct of monetary policy whether the country is assumed to be on a fixed or a floating exchange rate. A discussion of the issues involved in the choice between the two alternative exchange-rate systems is beyond the scope of this paper: this section is confined to the implications of that choice for what it is possible for monetary policy to attempt or attain. These implications are, however, relevant to the discussion of which exchange-rate system is preferable.

The point of most importance is the familiar one that a country on a fixed exchange rate is obliged to conduct its economic policy so as to keep its balance of payments balanced. More precisely, a fixed exchange rate obliges a country to keep fluctuations in its balance of payments within the limits set by its available international reserves, supplemented by its international borrowing power. Given the importance of short-term capital movements in the contemporary world, and their volatility in responding to interest-rate differentials or speculative sentiments, a country on a fixed exchange rate is likely to be obliged to conduct its monetary policy primarily by reference to the effects of domestic interest rates on international capital movements, and this may well necessitate the pursuit of a monetary policy contrary to that indicated by the objective of domestic economic stabilization.\* In addition, the need to command international confidence, imposed by the presence of a large volume of internationally mobile short-term capital, may restrict the freedom of the monetary authority to use all the elbow-room potentially available to it, since confidence is inspired and maintained by conformity to what is regarded as orthodox financial behavior by other central banks and the owners of internationally mobile capital. Finally, the adoption of a fixed exchange rate may aggravate the task of economic stabilization because it provides maximum scope for the transmission of expan-

\* In principle, the effect of international capital movements on the country's international reserve position could be overcome by operations in the forward-exchange market aimed at eliminating the covered interest differential between domestic and foreign capital markets. This technique was recommended to the Radcliffe Committee but rejected for what seem to be largely institutional reasons. The workability of the technique has been the subject of a continuing controversy among the experts; the United States monetary authorities claim some success in using it in the past two years. Whether it could be an adequately effective insulator for Canadian monetary policy is a question beyond the scope of this paper; suffice it to remark that exploitation of the technique in support of a monetary policy aimed at short-run stabilization would involve a higher degree of sophistication in monetary policy than has been customary in the past, and possibly a greater chance of error.

sionary and contractionary developments in foreign economies to the domestic economy.

A fixed exchange rate, in short, introduces the likelihood that a country will have to endure internal instability, either as an automatic result of the link with conditions in the rest of the world forged by the fixing of the exchange rate or as a consequence of pursuing the monetary policy required to balance the balance of payments by inducing appropriate movements of international short-term capital. A floating exchange rate, by contrast, provides more scope for the pursuit of an independent monetary policy. It does not of course insulate the economy from the influence of favorable or unfavorable developments in foreign markets, or from the impact of short or long-term capital movements; but it does permit the economic authorities to attempt to prevent such developments from giving rise to fluctuations in the level of economic activity.\*

The implications of the difference between the two exchange-rate systems for the choice between the three alternatives would seem to be as follows. First, since a fixed-rate system obliges monetary policy to be conducted primarily by reference to the state of the balance of payments, it necessarily lowers the standard of stabilization that can reasonably be expected either from monetary policy as practised in the past or from an improved system of monetary management, by comparison with a floating-exchange-rate system. Second, insofar as adherence to a fixed-rate system obliges a country to practice orthodox central banking, both in order to command foreign confidence and because the fixed-rate system as currently operated involves a considerable amount of cooperation among central bankers, such adherence tilts the balance in favor of accepting the limitations of economic stabilization by traditional methods of central banking, rather than attempting to improve the performance of monetary policy by radical reform of the constitution and operating methods of the central bank, whereas adherence to a floating-rate system would tend to tilt the balance in the opposite direction. In addition, as already mentioned, adherence to a fixed-rate system greatly complicates the question of how, in fact, a better performance with respect to stabilization could be secured in practice. Thirdly, adherence to a fixed-rate system reinforces the argument for relieving monetary policy of the responsibility for economic stabilization, since it automatically imposes on monetary policy the

\* The extent to which a floating exchange rate provides this extra freedom of manoeuvre depends on the degree to which wages and prices in the economy are "sticky," so that relative domestic and foreign costs can be altered more easily by exchange-rate changes than by inflation or deflation of demand.

prior responsibility of controlling international capital movements. But this additional responsibility undermines the case for directing monetary policy toward the creation of a stable long-run monetary environment, since if monetary policy is not directed at the control of international capital movements some other means has to be found to control either capital movements or the balance of trade, and the most direct means of doing this—exchange controls and trade controls (which include such devices as temporary tariff surcharges)—may well be either impossible to operate efficiently enough to be worth the effort, or, if efficient, more disruptive than the use of monetary policy for the same purpose. Under a floating-exchange-rate system, on the other hand, the problem of balancing the balance of payments does not exist;\* the choice between the three alternatives is more definitely arguable in terms of strictly economic considerations; and the balance is tilted somewhat in favor of the third alternative by the fact that to some extent movements of the exchange rate will serve as an automatic stabilizer insulating the economy from changes in world markets.

#### *Alternative Guiding Principles for Future Policy*

The preceding sections have outlined certain fundamental assumptions concerning the nature of central banking, the influence of monetary policy on the economy, and the philosophy of economic policy, and indicated the relevance of the choice between a fixed and a floating-exchange-rate system to the potentialities of monetary policy. The following sections discuss the three alternative approaches to the future conduct of monetary policy outlined in the introduction. In each case, the relevant section outlines the rationale of the approach under discussion, and describes briefly the kinds of recommendations for change in the conduct of monetary policy that adoption of the approach might suggest.

##### (a) Lowering the Expected Standard of Performance of Monetary Stabilization Policy

There are several grounds for arguing that the unsatisfactory record of monetary stabilization in Canada in recent years represents about as good a performance as can reasonably be expected, and that the inference to be drawn from this experience is that expectations of per-

\* The balancing of the balance of payments may be secured by an inflow of foreign capital which is regarded as undesirable on some extraneous ground such as the dislike of American ownership of Canadian assets. The solution to this problem, if it is regarded as a problem, is clearly to increase Canadian savings and provide more incentive to Canadians to hold equities; both objectives would be served by a combination of surplus budgeting and easy money.

formance have been set impossibly high and should be revised downward.

In the first place, it can be argued that the openness of the Canadian economy to the world economy, and particularly the dependence of the Canadian economy on the American industrial complex for markets for Canadian resource products and on the American capital market for capital for Canadian economic development, makes the Canadian economy respond sensitively to fluctuations in the rest of the world, and particularly in the United States, and narrowly restricts the possibilities of economic stabilization by domestic economic policy. On this argument, the unsatisfactory record of stabilization in Canada in recent years predominantly reflects the effects on the Canadian economy of the slowing down of American economic growth, and the balance-of-payments difficulties under which the United States has labored in the same period; there is little that the Canadian policy-makers could do, or can be expected to be able to do in the future, to offset destabilizing influences emanating from the world economy. It can further be argued that over the long run Canadian prosperity and growth is best fostered by active participation in a liberal system of world trade and payments, and that the consequential exposure to economic fluctuations emanating from the world economy is a necessary price of long-run economic gains.

Secondly, it can be argued that the task of economic stabilization is inherently an extremely difficult one, and that there is no obvious way of effecting a significant improvement in its performance. The effects of monetary policy on the economy, in particular, are diffuse and far from predictable, and it is extremely doubtful how far monetary policy can successfully offset the effects of economic disturbances. Nor, it may be added, does the existing state of economic knowledge, whatever it may have to say about the theoretical possibility of efficient economic stabilization, hold out much prospect of significant improvement in the practical achievement of stabilization in the near future. At the present time, economic theory for the most part can contribute only a description of intricate economic relationships that must be better understood before stabilization policy can be made more efficient. That being so, the most that can be expected is a gradual improvement of performance as knowledge and experience accumulate.

Finally, it can be argued that the unsatisfactory performance of monetary policy in the past cannot be reasonably attributed to any easily remediable defects in the institutional arrangements for the conduct of monetary policy. A central bank, it can be argued, has been found by historical experience in the Western world to be the most

appropriate institution for the conduct of monetary policy. Its partial independence of the government is essential to the role it has to play in relation to the domestic financial community and the international financial world. As a responsible institution, it can be trusted to seek the knowledge it needs to operate effectively, to exercise the best judgment of which it is capable in formulating monetary policy, and to learn from experience. Like any institution or individual entrusted with the exercise of judgment, it may make mistakes, either because the situations in which it must act are complicated, or because it is influenced by a transient climate of public opinion, or because the exercise of its powers and responsibilities affect its judgment. But the probability of mistakes is inherent in the process of entrusting decisions to the judgment of responsible institutions or individuals, and the risk of mistakes is the price that must be paid by a nation for attempting to improve its economic management by centralizing the control of economic decisions in the hands of responsible public servants. If on the average the record of economic management is not very satisfactory, the correct inference is that the possibilities of achieving economic improvement by entrusting important decisions to the judgment of responsible institutions are more limited than had been thought.

If these arguments are accepted, and the position is taken that the unsatisfactory record of the past implies a need to write down expectations concerning the degree of economic stabilization attainable in the future, the main positive recommendation that emerges is that the public, the government, and the central bank should neither expect very much from monetary policy nor attach too much causal importance to it. This recommendation could be implemented in part by explicit incorporation in the Bank of Canada Act of the principle that the Minister of Finance, or the Government, is ultimately responsible for monetary policy, together with revisions of the wording of the Preamble to the Act designed to convey the sense that the objectives of policy listed are objectives of the Government's economic policy, and that the responsibility of the Bank is to conduct the day-to-day management of monetary policy so as to implement these objectives so far as is possible by monetary means. The purpose of both amendments would be to make the language of the Act reflect the view of the potentialities of monetary stabilization to which the arguments outlined above lead, while at the same time giving legal expression to the instrumental conception of the central bank on which the analysis of this paper is based.

The position that the degree of stabilization attainable by monetary policy is lower than has generally been regarded as satisfactory carries some other implications. If the standard of performance that can be

expected of monetary policy is revised downward, there is still a choice open between accepting a lower standard for stabilization policy, and attempting to achieve some of the ultimate objectives of stabilization policy by other means. Three alternative forms of action along the latter line are conceivable and could be recommended. The first is to develop instruments of stabilization alternative to monetary policy of the traditional kind; such instruments could be either fiscal devices, or selective instruments of credit control—the latter are discussed in a subsequent section. The second is to develop or improve the means of compensating or offsetting the social consequences of instability, particularly of unemployment on the one hand and inflation on the other, and to recognize that if a socially undesirable degree of instability is regarded as economically unavoidable its effects could be mitigated by greater generosity toward the victims. The third alternative is to attempt to improve the capacity of the economy to absorb and adjust to instability with less damage; this would require more determined efforts to make management and labor more flexible and mobile than they are now.

(b) Improving the Performance of Monetary Stabilization Policy

In order to argue that the performance of monetary stabilization policy could be substantially improved, it is not sufficient to point to the unsatisfactory record of the past and claim in the light of hindsight that the monetary authority should have been able to do better. Nor is it enough, to ensure improvement, to recommend that the Bank should become generally more alert, intelligent, and flexible. A serious argument must rest on a demonstration that monetary policy in the past has made errors that would, at least on a balance of probabilities, have been avoided had the system of monetary management been different, and different in certain definable ways.

Such a demonstration is extremely difficult; not only does it require a detailed examination of the past, and specifically of the state of opinion and the economic knowledge available at the time when various key decisions were taken, but it also requires a hazardous exercise in analysis of the might-have-been. What follows is not intended as an expression of the author's own views on these questions, but simply as an outline of a position to which an assessment of the evidence might lead and an exploration of its implications.

It can be argued that the performance of monetary stabilization in Canada in the recent past has fallen seriously short of an attainable standard for one or both of two major reasons, both of which reflect defects in the Canadian system of monetary control that could be

remedied by changing the present arrangements for monetary management.

The first argument is that, either because the democratic governmental process failed to reflect accurately the preferences of the public, or because the ambiguity of the Bank of Canada Act with respect to the ultimate responsibility for monetary policy allowed the Governor of the Bank to impose his own preferences, the priorities according to which monetary policy was conducted were at variance with the priorities that public opinion would have approved. Specifically, monetary policy attached unduly heavy weight to the objective of preventing or restraining inflation, and unduly little weight to the objective of maintaining high employment.\* Accordingly, it can be argued, the performance of monetary policy would have been better had the objectives of policy conformed to the preferences of the public; and performance in future could be substantially improved by ensuring that the objectives of policy pursued by the Bank do conform to the preferences of the public.

The specific recommendations to which a position based on this argument would lead depend crucially on whether it is maintained that failure in the past was the result of the Bank taking a different view on objectives than the Government, or of the democratic system failing to generate an accurate indication of the public's preferences.

If it is maintained that the failures of the past were due to the excessive exercise of independence by the Bank, the logical recommendation would be for reforms of the Bank's constitution designed to give the Government control over its actions. A minimal step in this direction would be to revise the Bank Act to assert explicitly that the Government is ultimately responsible for monetary policy, and that the Bank functions as the Government's monetary agent. This step, however, might accomplish little by itself. It would oblige the Bank to exert itself to discover the Government's policy intentions and priorities, at least in general terms, and to ensure that the Government regarded the monetary policy being pursued as consistent with its general economic objectives; but it would not oblige the Government to assume an active responsibility for the conduct of monetary policy, in the sense of laying down the lines to be pursued by monetary policy.

\* This argument is admittedly a difficult one to substantiate, since it depends on positing the existence of an ascertainable public opinion on the priorities of policy, and runs the danger of arguing from hindsight or of confusing personal preference with public opinion. Its plausibility must rest heavily on the facts that a large proportion of the country's academic economists disapproved of the Governor's monetary policy and expressed that disapproval publicly, and that the Government found it necessary eventually to remove the Governor of the Bank from his office.

To ensure that the Bank's conduct of monetary management did in practice conform to the Government's policies closely enough for the Government to be actively responsible for monetary policy, it would probably be necessary to oblige the Bank to look to the Government, not merely for general directions concerning the objectives to be pursued and the relative priorities attached to them, but for specific directions concerning the concrete monetary operations that the Government considered to be required by its general economic policy. A formal method of doing this would be to oblige the Government, acting through the Minister of Finance, regularly to communicate to the Governor of the Bank its views on what monetary policy should be. An alternative would be to strengthen the influence of the regular government departments primarily concerned with economic policy on the formulation of monetary policy, perhaps by setting up an interdepartmental committee to advise the Governor of the Bank.

If past policy failure is attributed to failure of the democratic governmental system to reflect public preferences with adequate accuracy, the problem of securing a substantially improved performance is much more difficult. There are two not necessarily mutually exclusive lines on which improvement could be sought. The first would aim at improving the expression of public opinion through Parliament. On this line of approach, the basic problem is the general one of securing effective democratic government by improving the quality of public understanding and discussion of issues so that public opinion is brought to bear on governmental decisions while they are being formulated, rather than left to be expressed in electoral approval or disapproval of the results of these decisions. This is a problem in public education—in the present context, of education of the public in the economics of policy choices—and it is doubtful how far such education can be promoted by changes in the institutional arrangements for the conduct of monetary policy. It is, however, arguable that the quality of public discussion and understanding of the issues involved in the use of monetary policy would be substantially improved if the Bank were obliged to publish regularly its own account of the actions it had taken, the purpose of these actions, and the results expected to follow from them, all in terms sufficiently concrete to permit informed discussion and appraisal.

The line of action just described assumes that Parliament is the proper body for the expression of public opinion and its translation into policy, and that it is the responsibility of the Bank to be guided by public opinion as represented by the Government in office. The alternative line of action rests on the different assumption—one that is more in keeping with the tradition of central banking—that elected govern-



ments are fallible and not entirely to be trusted, especially in matters of monetary management, and that it is the responsibility of central banks to formulate their own view of the public interest and pursue it, as the phrase goes, to the point of "nagging" the Government. On this assumption, the failure of the past is attributable to inadequate or biased representation of public opinion in the management of the Bank, and the indicated line of reform would be to strengthen the representation of public opinion on the Bank's Board of Directors. Specifically, it can be argued that by the very nature of central banking financial opinion is likely to have an excessive influence on the Bank's thinking, and that this influence should be counterbalanced by functional representation of other sectors of the economy on the Board. In addition, it could be argued that since monetary policy affects the whole economy in a variety of complex ways, special representation should be given to professional economists, whose business it is to understand and study how the economy works.

The foregoing discussion is concerned with the contention that the past failures of monetary policy are in large part attributable to a failure of monetary policy to reflect the public's preferences with respect to the priorities of economic policy, a failure that could be remedied by improving the arrangements for monetary management. The second argument attributes past failure, not to the pursuit of objectives different from those preferred by public opinion, but to failure of the Bank to understand the economic relationships on which monetary policy was seeking to operate, or to make use of the available economic knowledge concerning those relationships, let alone attempt to improve on that knowledge. This attribution is much easier to support than the other, inasmuch as the economic analysis and assumptions employed in formulating the Bank's policy are on public record in the Annual Reports of the Bank and the speeches delivered by the Governor, and can be shown—in fact, have frequently been shown—to be illogical, inconsistent, inadequate, or factually wrong in a variety of respects crucial to efficient policy formation.

Given that the Bank in the past has displayed an alarming ignorance of elementary economic principles, not to speak of the results of scientific economic research, it can be argued that the performance of the Bank would have been much better had it possessed and applied an up-to-date knowledge of economics, and that its future performance could be substantially improved if it were made to realize the importance of economic science and research to its work, and obliged to base its policy actions on a thorough economic analysis of policy alternatives

and consequences, and to improve its economic knowledge by a continuing large-scale research effort.

This prescription could be implemented by a variety of changes. The relevant recommendations could include the appointment of senior economists to the Board of Directors; a program of exchanges between the Bank's staff of economists and economists in the universities; regular informal conferences of Bank officials and academic economists to discuss technical problems of monetary management or the bearing of general economic problems on monetary policy; regular publication of the results of the Bank's own research in a journal open to contributions from outside economists.

Many of such changes could easily be effected by the Bank itself; that the Bank has not chosen to introduce them points to the main source of doubt concerning the probable effectiveness of this prescription, since it indicates that the Bank itself does not consider that more extensive and intensive use of economics and economists would help it to perform its duties. For the prescription to work, it would not necessarily suffice for the Bank to have to employ and argue with economists; the language of economics, like the language of the law, can be used to conceal the truth as well as to discover it, and the employment of an economist, like the employment of a lawyer, is not necessarily a guarantee of honest intentions. What the prescription aims at is to convert the Bank, as an institution, from the banker's habits of thought to those of the economist. Whether this could be done, and whether if it could be done the Bank could still function effectively in its relations with the financial system, are difficult questions whose answers depend on the institutional character of central banking. So far as the first question is concerned, it seems clear that the Bank's personnel would have to be persuaded of the value of the scientific approach to its problems. This would have to be achieved by experience; probably the most effective ways of making the bank undergo the experience would be to appoint senior professional economists to the Board of Directors, and to oblige the Bank to publish detailed economic analyses of its policy choices and their results, preferably with a commentary by independent economists. So far as the second question is concerned, avoidance of possibly serious disturbance of the traditional understanding between the Bank and the domestic and international financial communities might require an improvement in these groups' understanding of the economics of policy, highly desirable in itself but unattainable in practice. Nevertheless, the effort and risks involved in converting the Bank to a more economically oriented in-

stitution might well be considered worth undertaking, if the result promised to be a substantial improvement in the performance of monetary stabilization policy.

(c) Abandoning Short-Run Stabilization in Favor of a Stable Monetary Environment

The preceding two subsections have been concerned with the alternative positions that past experience indicates that a lower standard of achievement should be expected of monetary stabilization policy, and that an appreciably better performance could be ensured in future by revising present arrangements for monetary management either to make the central bank's actions conform more closely to public preferences, or to make its operations more scientific, or both. This subsection is concerned with the third alternative, that the attempt to achieve short-run economic stabilization by monetary policy should be abandoned, and that instead monetary policy should be directed to creating a stable monetary environment in the economy.

There are three main arguments for the abandonment of short-run stabilization as a primary objective of monetary policy. The first starts from the observation that while in principle it should be possible to operate monetary stabilization policy efficiently, because monetary action can be taken swiftly and can be finely adjusted, in practice the use of monetary policy for stabilization purposes has been laggard and clumsy in its recognition of and reaction to both short-run changes in the contemporary economic situation and long-run changes in the economic environment. More specifically, monetary-policy changes have consistently lagged significantly behind changes in phase of the business cycle. What is more important, changes in the priorities among objectives expressed in monetary policy have lagged long behind changes in the economic environment or conjuncture: monetary policy in the period from the end of the war to the early '50's—a period of economic euphoria—was preoccupied with the danger of a deep recession, with the result that it contributed to inflation; it then became preoccupied with the dangers of inflation, about the same time as the economic climate changed toward one of chronic depression, with the result that it contributed to unemployment and slow growth. Delay in the recognition of economic changes and adjustment to them, it can be argued, is inherent in the nature of policy-making institutions in a democratic society; but it is especially ingrained in the nature of the central bank, which lacks the mandate of an elected government to act speedily in emergencies. That being so, the central bank should not be entrusted with the responsibility for stabilization policy, since

effective performance of that responsibility would require it to act with a speed and foresight, and a willingness to court unpopularity, that is contrary to its institutional nature and the political framework within which it must operate.

The foregoing argument derives from consideration of the position of the central bank in the system of government. The second argument derives from consideration of the institutional nature of the central bank and its position in the economy. The central bank, it can be argued, is primarily a banking institution, and its main business is with commercial banks and other financial institutions. Its organization and traditions are adapted to that role; they are not designed specifically for the purpose of control of the economy by manipulation of the money supply, and the degree to which they can be adapted to that purpose is severely limited. On the one hand, the position of the central bank in relation to the economy is not such as to encourage or force it to think continually of the requirements of the economy as a whole, but rather such as to concentrate its thinking on the requirements and interests of the financial sector. On the other hand, pursuit of a vigorous monetary policy directed at economic stabilization necessarily brings it into conflict with the interests of the financial institutions with which it normally works, a conflict it will naturally wish to evade or avoid. In short, reliance on monetary policy for short-run stabilization involves entrusting the job to an institution that is neither well equipped for nor single-mindedly enthusiastic about the responsibility. It can be argued that the prospective degree of stabilization attainable is not worth the difficulty of attaining it, and that it would be better to try to achieve economic stabilization by some other means.

The third argument is concerned with the economic possibility of stabilization by monetary means. As has been mentioned in an earlier section, economists have had little difficulty in verifying that monetary policy can influence interest rates and credit conditions, and great difficulty in detecting the influence of the latter, or of the quantity of money itself, on economic activity. Nevertheless, very few economists would be prepared to assert, and certainly none has ever attempted to prove, that monetary policy has no influence whatever on the economy. The most plausible view, on the basis of research to date, is that monetary policy has an influence on the economy that varies in magnitude and in timing and is by no means easily predictable. This in itself would suggest that the use of monetary policy for short-run stabilization might do more harm than good, the disturbance resulting from unintended or unanticipated effects of monetary-policy actions outweighing the intended beneficial effects. Further, recent theorizing on these matters sug-

gests that one reason why the influence of monetary policy is difficult to detect is that enterprises and individuals make their plans on the basis of expectations about the normal state of the economy, including the normal state of credit conditions, and that these expectations adjust only slowly to changes in the way monetary policy is conducted. This line of thought readily leads to the conclusion that the vigorous pursuit of monetary stabilization policy may be not only not very effective in the short run but of decreasing effectiveness over time, since the economic decision-units at which monetary policy is directed will learn to manage their affairs so as to avoid being disturbed by changes in monetary policy; and to the further conclusion that vigorous use of monetary policy may impede the long-run growth of the economy, by adding to the uncertainties of economic decision-making and reinforcing speculative pressures that tend to keep long-term interest rates high.

All three of these arguments lead to the conclusion that the attempt to achieve economic stabilization by traditional monetary means should be abandoned, and that the objective of stabilization should be approached in some other way; none of them, however, excludes the possibility, explored in the next section, that a useful improvement in stabilization might be attainable by the use of selective credit controls. All three also imply, though with varying emphasis, that monetary policy ought to be directed toward the creation and maintenance of a stable long-run monetary environment for the economy. The first argument would suggest that since the monetary authority is likely to be a bad judge of what the current state of the economy requires in the way of monetary policy, it should be given the simpler task of concentrating on the long-run monetary requirements of a growing economy. The second argument would suggest that the central bank is especially equipped by tradition, experience, and institutional role to promote and police the development of the country's financial institutions and to maintain orderly conditions in its security markets—particularly to cushion the disturbing effects of governmental fiscal and debt operations. The third argument would suggest that the central bank can contribute most effectively to both short-run stabilization and long-run growth by following a definite, well-understood and publicized, consistent policy in its monetary operations, one to which it is committed sufficiently long ahead for borrowers and investors to be able to plan with confidence.

The difficulty with recommending that monetary policy be directed to creating and maintaining a stable long-run monetary environment is to give this recommendation a concrete content. Two concrete proposals have been advanced and canvassed in recent years. One is the

Radcliffe Committee's proposal that monetary policy should seek to stabilize long-term interest rates at a level appropriate to the long-run balancing of savings and investment at a high employment level. The other is the proposal advanced by various American economists, that the money supply should be expanded at a constant rate based on the long-run growth rate of demand for money. The difference between the two proposals reflects partly a difference between the British and American institutional systems of monetary control—the British system concentrating on changing interest rates and the American on changing bank reserves and the quantity of money—and partly a difference in basic monetary theory, which resolves essentially into a difference over empirical facts. The Radcliffe proposal assumes either that fluctuations in the economy originate predominantly in changes in the demand for money that could be counteracted by changes in the amount of it supplied, or that the demand for output is insensitive in the short run to changes in interest rates; the alternative proposal assumes that fluctuations in the economy originate predominantly in changes in the demand for output that do not alter the demand for money, and that interest rates have a negligible influence on the quantity of money demanded. Since fluctuations may originate in both monetary and real disturbances, and both the demand for output and the demand for money are likely to be responsive to changes in interest rates to some extent, adoption of either proposal would entail some possibility of destabilization by comparison with an ideal stabilization policy. In the case of real disturbances, the Radcliffe proposal would eliminate both the stabilizing effects on expenditure of automatic increases in interest rates in booms and decreases in interest rates in depressions and the further stabilization that could be effected by countercyclical monetary contraction and expansion. The alternative proposal would eliminate the possibility of counteracting monetary disturbances, and in the case of real disturbances would allow fluctuations in interest rates to induce increases in velocity in booms and decreases in velocity in depressions, these changes in velocity serving to accommodate a fixed stock of money to a varying level of output and activity. The destabilizing effects of either alternative, it can be argued, would be small by comparison with the destabilizing effects of active monetary stabilization policy as conducted in the past, and by comparison with the gains from a more stable monetary environment.\*

The Radcliffe proposal was a recommendation to the central bank and the economic policy authorities; the American proposal is some-

\* The last half of this paragraph has been revised as a result of discussion with Alvin Marty.

times intended to be translated into legislation binding the central bank to expand the money supply at a specified rate. Such a statutory restriction on the central bank's freedom of action is alien to the tradition of British central banking, and presumably could not be contemplated; nor is the state of knowledge concerning monetary behavior sufficiently advanced to permit the devising of a rule that would not run the risk of becoming inappropriate. The spirit of the two proposals could, however, be expressed in a recommendation to revise the Bank Act to make the Bank's primary responsibilities those of fostering the growth of the country's monetary and financial system, and maintaining a stable monetary environment in Canada, and to impose on the Bank the obligation not only to devise its policy with reference to those objectives, but to announce and explain publicly what its monetary policy is and will be for some reasonable time into the future. Whether the policy was to be expressed in terms of interest rates on certain government securities, or in terms of the rate of expansion of the money supply, could either be specified statutorily, or left to the Bank's discretion.\*

### *New Controls Over Credit*

The preceding section dealt with three alternative approaches to the future use of monetary policy—acceptance of a lower expected standard of performance with respect to economic stabilization, determination to improve that performance in the future by reform of the system of monetary management, and alteration of the objective from economic stabilization to the creation of a stable monetary environment. Each of these approaches is consistent with the recommendation that the traditional techniques of monetary management be reinforced by the introduction of various kinds of selective controls over the granting and use of credit. It can be argued that even though the degree of stability achievable by monetary policy is not high, it would be higher if the monetary authority had the power to strike more directly at sources of instability, or that a more determinedly scientific approach to stabilization should be empowered to use techniques that analysis of the sources of instability suggests might be more effective than orthodox techniques; or that the use of selective credit controls could contribute significantly to stabilization without disturbing expectations

\* The recently revived technique of a fixed Bank rate is a device for committing the Bank to pursuing a stable policy in the very short run, and changing it only at intervals and by degrees to which the money market is accustomed. The position discussed in this subsection is essentially that a technique of this kind should be developed on a time-scale appropriate to the financial planning of the productive sector of the economy.

and increasing uncertainty as much as would the use of orthodox monetary policy.\*

The purpose of this section is to explore the merits and drawbacks of various types of selective control over credit. Such selective controls can be divided for discussion into four types—"moral suasion," controls over bank behavior, controls over other credit institutions, and controls over particular types of borrower. Since the use of selective controls in any form raises some issues of a general nature, and since this paper cannot embrace a discussion of all the specific kinds of selective control that might possibly be considered, discussion of the four types of selective control just mentioned is preceded by a brief statement of some of the general issues.

#### (a) Some General Issues

Any attempt to use control of the money supply and credit conditions to stabilize the economy, whether the method employed is "general" or "selective," must necessarily operate indirectly. What matters for economic activity is the level of spending, not of borrowing in general or in certain specific forms, and monetary or credit control must operate through whatever influence the quantity of money, interest rates, or the availability of credit in general or in certain selected forms has on the level of spending. This means that selective credit control can only be effective to the extent that would-be spenders cannot resort to alternative financial institutions or alternative sources of finance than those over which control is exercised; and a primary question about any proposed device of selective credit control is the extent to which it can control actual spending, as distinct from merely altering the form in which spending is financed. The answer to this question obviously depends not only on the particular device under consideration, but also on the length of time over which the device is intended or required to be effective. Over the course of time, would-be borrowers deprived of access to their customary sources of finance will learn to resort to alternative sources, or to manage their affairs so as not to be dependent on their previous sources; similarly, competition among lenders will in the course of time develop substitutes for institutions and types of lending resort to which is restricted by selective control.\*\* Thus

\* The argument here would be that the use of selective methods explicitly recognizes that the circumstances are abnormal, and therefore minimizes the disturbance to long-run expectations. The validity of this argument clearly depends on selective controls being used infrequently and for short periods; if they became a permanent feature of the economic environment, their use for economic stabilization could raise the same problems as the use of monetary policy.

\*\* For example, the pressure of rising interest rates against legal limits on the interest



heavy and sustained reliance on selective controls may be self-defeating, and may have the long-run consequence of reducing the efficiency of the financial system and the economy by fostering the substitution of inherently less efficient for inherently more efficient financial institutions and practices.

Because the efficiency of selective controls depends on their frustrating the plans of would-be spenders who are dependent for finance on the specific credit institutions or forms of credit subjected to control, selective controls are inherently discriminatory between spending units. Should this consideration be a matter for serious concern? It can be argued—the contention that “general” monetary control is non-discriminatory to the contrary—that “general” monetary policy is equally discriminatory, since it in fact operates in part through the rationing of credit among borrowers by banks and other lenders. It can also be argued that any policy of economic stabilization is inherently discriminatory in the sense that it will entail frustrating the plans of some economic units (consumers or firms), and that the distribution of frustration among the units will necessarily be to some extent fortuitous. The practical question therefore is whether the inequity involved in any particular device of selective control is tolerable, in conjunction with the contribution to stabilization it makes.

To put the argument of the two preceding paragraphs a rather different way, the important economic fact is not so much that selective controls discriminate against some types of economic units, as that they discriminate against established efficient methods of financing. And the important economic question is not so much whether they are effective enough to justify their inequity, as whether the leverage gained by discriminating occasionally against efficient financing methods is worth the possible long-run loss of economic efficiency that this discrimination may produce.\*

The possible long-run distorting effects of the discrimination implied by selective controls are particularly important in the case of selective

---

rates payable on deposits and chargeable on loans has led the chartered banks to develop new deposit instruments and loan forms that enable them in fact to exceed these limits. At the same time, these and other restrictions on the banks' freedom to compete in the deposit and loan market have fostered the growth of other deposit-taking and loan-making institutions, such as the trust companies and the finance companies.

\* There is a close analogy between the use of selective controls on credit and the intermittent use of specific taxes such as capital levies or tariff surcharges. Both raise questions of equity, which have to be resolved by reference to established standards of equity, and both, if frequently resorted to or prolonged, may distort the economy into an inefficient structure.

methods of control applied to the operations of the chartered banks. In effect, the obligation imposed on chartered banks to maintain a minimum non-interest-yielding cash reserve in the form of Bank of Canada notes and deposits constitutes a tax on the chartered banks, levied in return for the privilege of conducting a banking business. Other restrictions on the chartered banks' freedom to determine the composition of their assets, such as the minimum liquidity ratio and other proposed devices to force chartered banks to hold government debt, constitute additional taxes—as do legal restrictions on the rates banks may charge. The use of such restrictions and variations in them to assist stabilization policy may in the long run retard the development of the banking system and foster the development of other less efficient institutional arrangements for conducting business the banks are best equipped to handle. In a concentrated banking system like the Canadian one, the use of selective controls directed at the banks may also encourage the banks to develop arrangements among themselves similar to those of cartels and combines, and oblige the central bank to accept such arrangements, as compensation for the loss of profit opportunities resulting from selective controls. Thus the distortions resulting from discriminatory treatment of banks may be aggravated by the distortions resulting from monopolistic practices.

One further comment is in order. Since discrimination is generally regarded as ethically undesirable, there is a natural tendency to condone or recommend it particularly in cases where the activities or economic units against which it is directed can also be considered as ethically or morally undesirable. Specifically, there is a strong tendency in discussions of selective credit controls to favor controls on the finance of speculation in stocks and real estate, on the grounds that speculation is a morally reprehensible activity, and on consumer finance, on the grounds that it is immoral for wage and salary earners to pledge their future earning power. Both types of financing can in fact be defended as rational activities which can contribute to the improvement of economic efficiency and welfare in the same way as any other kind of borrowing—speculation by leading to a more efficient allocation of assets among uses, instalment buying by leading to a more efficient allocation of consumption over time. If nevertheless it is considered that they should be restricted on moral grounds, the presumption should be that they are equally immoral whether the economy is booming or slumping, and should be dealt with by permanent measures.\* The only

\* One important reason for the condemnation of speculation, in addition to the usual sober citizen's dislike of seeing someone else get something apparently for nothing, may be the realization that present tax laws give the speculator an enormous

possible economic argument for countercyclical selective control of them is that they contribute extraordinarily to economic instability. This cannot be readily demonstrated for speculation in stocks and real estate, which involves trading in existing assets; though it can be argued in the case of consumer credit, which finances the purchase of goods.

(b) Moral Suasion

For the purposes of this paper moral suasion has been classified as a type of selective credit control. Actually it occupies an awkward middle ground between the unobjectionable straightforward provision of information by the central bank about its own analysis of the economic situation and the best interests of private enterprises, and the use of explicit selective controls on credit, since it attempts to persuade economic decision-takers by one means or another voluntarily to take actions that the central bank wants them to take but cannot force them to take. Since the actions involved generally amount to some form of rationing of credit, and since the persuasiveness of the central bank ultimately derives from its powers of control over the money supply, moral suasion can however be assimilated more closely to selective credit control than to the proffering of disinterested objective advice.

The use of moral suasion by the central bank inevitably involves some conflict with the immediate economic self-interest of the institutions at which it is directed, which institutions must be persuaded to comply either on the general ground of responsibility to the community at large or on the narrower ground of good relations with the central bank. The extent to which institutions can be persuaded to act against their immediate self interest on these grounds obviously depends on a variety of factors, including the extent to which they can afford the loss of profits or of goodwill (in the first case) and the extent to which the central bank has power to discipline them (in the second case). It follows that moral suasion is more likely to be effective when directed at the chartered banks and other heavily concentrated sectors of the financial system and the economy than when it is directed at sectors characterized by keen competition among a large number of small firms. The more monopolized a sector is, the more dependent it is on governmental goodwill, and the more its activities are prominent in or open to public discussion, the more amenable it will be to control by moral suasion.

---

differential advantage over the citizen who earns his income by regular work. The appropriate remedy is not to try to hamper the speculator, but instead to remove the tax advantage by treating speculative capital gains as income.

These considerations suggest the first reservation about the use of moral suasion. Its effectiveness depends on the extent to which economic decisions are concentrated in the hands of a few units, which consequently can afford to allow what are essentially political considerations to override economic calculation. Correspondingly, reliance on it implies at least tacit approval of concentration of economic activity in a few decision-taking units, and assumption of some governmental responsibility for rewarding compliance with moral suasion by favors of some kind. The recognition of responsibility is usually a reciprocal relationship. It may be considered only realistic to recognize that economic control in Canada is concentrated; and it may even be argued that such concentration is desirable on various economic grounds. But it should be recognized that the use of moral suasion does raise the question of whether economic concentration is desirable, and that this question is a controversial one.

A second question relates to the objectives at which moral suasion is likely to be directed. Judging by past experience in Canada and elsewhere, moral suasion is likely to be directed at or canalized into restraining types of lending or spending that according to conventional financial thinking are unsound or morally somewhat shady, such as loans for speculative purposes or for consumer spending. Restraint of this kind may have little effect in controlling the true sources of instability, which often are simply excessive spending on thoroughly respectable projects. More generally, moral suasion raises the question of how far the monetary authority, in collaboration with responsible financial institutions and leading corporations, is competent to judge better than the competitive market process (or possibly an economic planning agency) what types of expenditures are in the national interest and what types are not.

A third question relates to the time lag inevitable in the use of moral suasion. For moral suasion to work, not only must the monetary authority and the government be persuaded that the economy is getting out of hand, but the financial and business community to which moral suasion appeals must also be persuaded. This presupposes that the need for action is apparent to all concerned; and this in turn ensures that action will only be taken with an appreciable lag.

On the other hand, there are two considerations favoring the use of moral suasion. One is based on the assumption that private enterprises, both financial and nonfinancial, are poor forecasters and poor interpreters of their own economic interests, and moreover react to economic changes with considerable inertia. Consequently, it can be argued, the adoption by the monetary authority of a definite simple line on the

nature of the contemporary economic situation and what action it calls for will be welcomed by the financial and business communities, and will speed up the change to policies that private-enterprise institutions would willingly follow if they were better informed and more flexible. This consideration amounts to accepting the proposition that in a complicated world, salesmanship has to substitute for perfect knowledge and wisdom, and assumes that imperfect guidance is better than none. The second consideration is based on the assumption that financial institutions are involved in intricate professional-client relationships with their customers, and that corporation management is built on a delicate balance of power among different departments, so that the application of the correct economic decisions is greatly facilitated if reference can be made to the overriding authority of the central bank's opinion. For example, it is frequently asserted that a directive or policy statement from the central bank makes it easier for commercial banks to refuse their customers loans while retaining their goodwill; and it is conceivable that the financial-planning departments of big corporations may be similarly strengthened in their resistance to overoptimistic expansion plans emanating from the production and sales departments. These considerations, of course, implicitly assume that the judgment of the monetary authority is both reasonably reliable, and expressed in terms that both are plausible and can readily be translated into action by the relevant private-enterprise institutions. Clearly, these assumptions limit the extent to which moral suasion can be relied on to improve the performance of economic-stabilization policy.

### (c) Control Over Chartered Banks

One of the reasons why orthodox monetary policy operates slowly and imperfectly in restraining a boom is that at the start of the upswing the chartered banks are typically holding a relatively high proportion of government debt and a relatively low proportion of loans. As the upswing proceeds, and the demand for loans grows, the banks can satisfy this demand even though monetary policy is restraining the growth of their total assets, by running off their holdings of government debt in order to finance the expansion of loans. In effect, this process transforms idle bank deposits into active deposits, owners of idle balances being persuaded by a rise in interest rates to surrender these balances to the banks in exchange for government securities formerly held by the banks, and the banks relending the balances to borrowers who wish to spend them. In a different terminology, restriction of the money supply by monetary policy is partially offset by an induced increase in the velocity of circulation.

It can be argued that the effectiveness of monetary policy would be significantly increased if the central bank had the power to prevent the banks from running off their holdings of government securities, for example by being empowered to impose a variable minimum ratio of "more liquid assets" to deposits, or a variable maximum ratio of general loans to deposits. Since the use of such powers would involve obliging the banks to hold more government securities than they would otherwise choose to hold, it could be argued that the granting of them would have the additional advantage of helping to keep down the cost of the public debt by partially insulating the government-securities market from the effects of restrictive monetary policy.

The quantitative magnitude of the influence on both aggregate spending and interest rates achievable by use of such powers depends on the extent to which spenders who normally finance themselves by bank loans have access to other sources of finance, or possess assets that can be sold or pledged to finance spending. The restraining effect on expenditures (and interest rates) would be greatest if everyone refused a bank loan had no alternative but to cancel his spending plans; even in this case some of the effect would be offset by the influence of lower interest rates in inducing larger expenditures by spenders not dependent on bank loans. The restraint on expenditures (and interest rates) would be virtually zero if all potential borrowers from banks had the alternative of financing expenditures by selling off holdings of government bonds. In general, the restraint achievable depends on the deterrent effect on would-be borrowers from banks of the higher cost of alternative means of finance. It is generally agreed that some groups of would-be spenders—notably small businesses and consumers—are sufficiently dependent on bank finance for the denial of bank loans to force them to cancel or curtail their spending plans. Thus, providing the banks do not channel their loans to such groups at the expense of other groups having access to alternative sources of finance, the powers of control under discussion could increase the effectiveness of stabilization policy to some significant extent.

Assuming that this kind of selective control of chartered-bank lending could contribute to stabilization, whether it should be employed depends on three sets of considerations. First, its use is an alternative to more vigorous and alert use of monetary restraint; instead of preventing the banks from lending as large a proportion of their total assets as they wish, the monetary authority could achieve the same effect on loans by restricting total bank assets more severely. Preference for the selective over the general method of control of bank loans must therefore be derived from an empirical judgment that the central bank

cannot or will not apply general monetary restraint quickly and subtly enough—that is, it cannot anticipate the banks' switch from government securities to loans—or from the view that a more active monetary policy would have undesirable destabilizing effects on the economy, or from the judgment that the government-debt market should be protected so far as possible from the impact of monetary restraint. In the second place, the concentration of the restrictive effect on spenders who are dependent on bank finance may be regarded as both unfair and economically undesirable. In particular, it is frequently argued that restriction of bank loans bears unduly heavily on small businesses, with effects deleterious to economic growth and favorable to economic concentration and monopoly and the control of Canadian enterprise by American capital. These effects, so far as they can be demonstrated to exist and to be avoidable by other methods of stabilization, have to be weighed against the improvement in stabilization achieved by selective control of bank lending. Finally, forcing the banks to hold more government securities and less loans than they would like amounts to imposing a special kind of tax on bank earnings; whether this tax amounts to a net burden or not depends on whether it is assumed that total bank assets would be the same with or without the selective controls, or that in the absence of controls the central bank would restrict total bank assets more severely. In either case, some intricate questions about the effects on the banks' earnings and competitive position are involved.

Essentially similar considerations to those last mentioned are involved in proposals to supplement existing methods of control over bank deposits by giving the central bank power to alter the reserve ratio the chartered banks are obliged to maintain, either by direct variation of the required ratio or by requiring the banks occasionally to hold additional reserves in the form of "special deposits," on which interest may or may not be paid.

In a modern central-banking system, the required reserve ratio serves two functions. First, it fixes the "expansion multiplier"—the number of dollars by which the commercial-banking system can expand deposits on the basis of a dollar increment to reserves. Second, it imposes a tax on the commercial banks, equal to the loss of interest on the portion of reserves they would not hold if they were not obliged to. This tax, whose burden rises and falls with the general level of interest rates, can be regarded as the price the banks must pay to the central bank, and indirectly to the government, for the services of the central bank and the privilege of operating a banking business. Its level influences in the short run the division of bank earnings between the banks and the

government, and in the long run the allocation of resources to the provision of banking services.

The use of variable reserve ratios rather than open-market operations with a fixed ratio to control the volume of bank credit can accordingly be recommended on two grounds. The first is that the central bank's control over bank deposits is closer, the higher the reserve ratio; and that close control is more desirable, and the burden of a higher reserve ratio on the banks more bearable, in the boom than in the slump. This argument assumes, plausibly, that banks will work closer to the minimum reserve ratio the higher that ratio is. The second argument is that raising required reserves in a boom will tend to restrain the growth of bank loans and the rise of interest rates in the same way as would requiring the banks to hold government debt directly, since reserves are an indirect form of public-debt holding. The factual assumption here is questionable, since taxing the banks by forcing them to hold larger reserves may increase their desire to hold loans rather than securities. On either argument acceptance of the recommendation involves the same considerations as before, a balancing of likely effectiveness in stabilization against considerations of equity and economic efficiency.

There is, however, a special set of circumstances in which the power to vary reserve requirements or to require the banks to hold special deposits may have particular advantages. A country on a fixed exchange rate may easily experience a rapid inflow of short-term capital; if the monetary authority wishes to prevent such a capital inflow from generating a multiple expansion of the domestic money supply, it may have considerable difficulty in doing so by open-market sales of securities, since the sales required may be extremely large. The desired insulation of the domestic monetary system could be secured more readily by requiring the banks to hold additional deposits at the central bank as reserves against the increase in foreign-owned deposits—in effect, the multiple-expansionary effect of an acquisition of foreign assets by the central bank would be offset by an increase in reserve requirements.

#### (d) Control over Other Credit Institutions

In the past seven or eight years the argument has commonly been advanced that monetary control of the economy has been weakened by the development of financial intermediaries which offer the asset-owner assets which are close substitutes for bank deposits. The presence of these intermediaries, it is argued, means that an effort to tighten credit conditions simply leads asset owners to transfer their assets from the



form of bank deposits into the form of substitutes for bank deposits; since the liabilities of financial intermediaries are backed by a fractional reserve of bank deposits, the effect is an increase in the total of money and close money substitutes that can be provided on the basis of a given amount of chartered-bank reserves provided by the central bank, so that the intentions of monetary control are frustrated, whether monetary control is conceived of as working through the total amount of money or through the amount of credit extended by financial institutions. Consequently, it is argued, effective monetary control requires that these financial intermediaries should be subjected to the same kind of cash-reserve requirement as are the commercial banks.

The importance of this argument depends on how far in fact monetary restriction leads to a transfer from bank deposits to the liabilities of financial intermediaries rival to banks. The empirical evidence produced so far does not suggest that such shifts are an important cause of frustration of monetary policy, or that the presence of financial intermediaries is a source of instability. To this proposition there is one important exception: the finance companies. In boom times the demand for instalment credit is so great, and so insensitive to the cost of instalment credit, that finance companies can offer very high yields to attract funds from alternative forms of liquid investment; by so doing, they provide finance for consumer purchases that add to the pressure of demand on available productive resources and so contribute to economic instability. Finance companies, however, are not generally considered to be close rivals to commercial banks in the same sense as other savings and deposit-accepting institutions; and proposals for controlling their activities are usually directed at controlling the terms of instalment finance, rather than the lending capacity of the companies. For this reason, such proposals are dealt with in the following subsection, on control of specific types of borrowing.

So far as other financial intermediaries are concerned, there would seem to be no empirical case for empowering the central bank to exercise control over their activities similar to that exercised over the chartered banks. There may, however, be a case on grounds of equity or financial efficiency for subjecting near-bank institutions to reserve requirements similar to those now imposed on chartered banks. The purpose of such a change would not be to improve the central bank's power to pursue economic stabilization—as already mentioned, there is little reason for believing that the central bank's control is weakened by the presence of financial intermediaries, and indeed so long as the public does not switch easily from bank deposits into close substitutes the presence of intermediaries may on the contrary increase the leverage

of the central bank on economic activity.\* On the contrary, the purpose would be to burden the intermediaries with the same taxation as the minimum cash-reserve requirement now places on the chartered banks. Whether this would constitute an improvement in equity and efficiency is a controversial question. As already mentioned, in return for this taxation the chartered banks receive certain services from the central bank, and enjoy the privilege of conducting a banking business. How far the services and the privilege are worth the tax paid for them is an extremely intricate question, as is the question of what equal conditions of competition between banks and near-banks would entail.

#### (e) Controls over Specific Types of Borrowing

The foregoing subsections have been concerned with controls over specific types of lending institutions. This subsection is concerned with the alternative type of selective credit control, which is directed at specific types of borrowing, rather than at lending by particular institutions. The argument for controls of this type is that certain kinds of borrowing finance types of expenditure that are of especial importance in the causation of economic instability; and the case for such controls must rest on demonstration that instability can be reduced—that is that instability of the relevant types of expenditure can be reduced—by controls on the financing of such expenditure. Given that certain types of expenditure can be identified as contributing to instability, the problem raised by such proposals is how far control of the finance of such expenditure can mitigate instability. This problem is a serious one, because on the one hand there is no sure way of identifying a dollar of borrowing with a dollar of expenditure, and on the other hand the same expenditure can be financed in a variety of ways, some of which may be difficult to control. Specifically, an individual or enterprise with a wide enough variety of assets or activities can always find a legitimate way of raising borrowed funds, regardless of the purpose for which the borrowing is intended; and similarly, if the demand for credit for some purpose is keen enough, the financial system can, given some time, always find a legitimate way of satisfying the demand.

\* The presence of financial intermediaries supplying assets very similar to bank deposits and holding a fractional reserve in the form of bank deposits means that the economy's total stock of "liquidity" or "money services" rests on a smaller fractional base of central-bank liabilities than it would if these intermediaries were not present. Consequently, so long as the public's division of its monetary assets between the various alternative forms, and the cash ratios observed by banks and competitive financial intermediaries, are reasonably stable, a given change in the central bank's liabilities will produce a larger absolute change in the public's stock of monetary assets when financial intermediaries are present than when they are not.

Three main types of borrowing are commonly assigned a special role in the generation of economic instability: instalment borrowing, particularly consumer instalment finance; borrowing for new capital investment; and borrowing for stock-market and real-estate speculation. Accordingly, it may be argued that economic stabilization could be more efficiently secured by empowering the central bank, or some other governmental agency, to control the terms on which consumer instalment credit is available, to license borrowing for new capital investment, and (or) to prohibit borrowing for speculative purposes or to control the terms of such borrowing.

So far as consumer instalment credit is concerned, it can be argued on the basis of the evidence that consumer purchases financed by such credit have been a destabilizing factor in recent economic fluctuations. It can also be plausibly argued that consumer instalment buying is relatively insensitive to changes in the rate of interest incorporated in instalment-credit terms, but is sensitive to the down payment required and the period over which repayment is spread (as incorporated in the amounts of the instalment payments). Finally, it can be argued that the inequity and economic inefficiency involved in curtailing consumers' ability to pledge their future earning power are of a lesser order of importance than the inequity and inefficiency of similar restrictions applied to productive enterprises. Consequently, it can be argued, control of the down-payment and maturity terms of consumer instalment credit offers the prospect of a significant contribution to economic stabilization at a relatively small cost in terms of inequity and inefficiency.

On the opposite side, it can be argued that the use of controls over the terms of instalment finance places an inequitably heavy burden on the members of the community who are dependent on the earning power of their labor, as contrasted with those who possess property on which they can borrow, or whose prospective earning power is sufficiently high and certain to enable them to borrow on their personal credit from a bank. It can also be argued that any substantive use of such powers of control will foster evasion either directly or through the development of techniques for renting the services of consumer durables rather than selling the goods themselves on credit; this has in fact been the American and English experience with controls on instalment finance. Finally, there is the possibility that the control of purchases of consumer durables through control of the terms of instalment credit will set up replacement or "echo" cycles in the purchase of such goods, which will aggravate the problems of the authorities concerned with economic stabilization in future.

According to accepted economic theory, the main source of fluctuation in economic activity is fluctuations in the volume of business investment, and one promising way of promoting economic stabilization is to stabilize the level of business investment. A possible approach to stabilizing business investment is to try to stabilize the amount of new borrowing for the purpose of business investment, by controlling access to the new capital market by the licensing of new capital issues, as was done in the United Kingdom for a long period.

Capital-issues control as a means of controlling new investment is however severely limited, especially in a country like Canada where firms have ready access to foreign capital markets. From a broad economic point of view, of course, the effect of control over access to the domestic capital market in inducing would-be borrowers to borrow abroad is not in itself objectionable, since restraint on new domestic capital issues would usually be introduced when the supply of domestic savings fell short of the demand for them, and foreign borrowing would tap foreign supplies of savings; still, the need to resort to foreign borrowing might unduly favor foreign control of Canadian enterprises. If, on the contrary, capital-issues control comprised both domestic and foreign flotations, it would raise problems both of interference with the activities of subsidiaries of foreign companies and of handicapping Canadian enterprises competing with foreign enterprises in the domestic and world markets. The main problem with capital-issues control, however, is that control of new capital issues is a remote and doubtfully effective way of controlling investment expenditure: the modern corporation can both finance itself by appropriations of current earnings, and plan its external financing to maximize its freedom with respect to the timing of its investment expenditures. It is probably safe to say that capital-issues control in the United Kingdom had little substantive influence on investment once physical controls over materials were abandoned, and that in fact it was never a major influence on investment, but only a device for ensuring orderly queuing of new issues in the capital market. More generally, capital-issues control is not a very promising device for control of investment, though it can be a useful financial adjunct of investment planning enforced by other means.

The third type of control over specific types of borrowing commonly recommended is control over borrowing for speculative purposes, especially stock-market and real-estate speculation. As previously argued, it is extremely difficult to establish that such speculative borrowing contributes to economic instability, since it involves the purchase of existing assets and not of currently produced goods. The most that can be argued is that the expenditure of speculative profits by

speculators who sell out to more optimistic speculators contributes to aggregate demand, and that a bull market for equities may cheapen the cost of new capital to corporate enterprises and stimulate new investment. How far the excessive optimism of the boom is fostered by increases in stock and real-estate prices caused by purchases financed on credit is an unresolved question; so is the question of how far it is possible to restrain increases in aggregate demand by impeding speculation through restricting the availability of credit to finance it. Anyone with assets can speculate without the assistance of loans from a bank or a broker, and anyone with personal credit can obtain funds that can in fact be used for speculation. There is therefore considerable doubt whether control of loans for stock or real-estate speculation can either prevent speculation or, even if it can do so, contribute much to economic stabilization.

The case is different with speculation in stocks of physical goods, and a somewhat better case could be made out for selective control of loans to finance the accumulation of inventories. Unfortunately, speculative inventory accumulation is difficult to distinguish from the increases in inventories necessary to efficient production at a higher level; and in any case inventories can be financed by other means than borrowing.

#### *Concluding Observations*

This paper has had two major purposes: to survey the alternative positions that may be taken with respect to the future conduct of monetary policy and the types of recommendations to which they lead, and to examine the possibility of increasing the power of monetary stabilization policy by the adoption of various types of selective credit control. Three alternative positions on future monetary policy have been distinguished: acceptance of a lower standard of performance, recommendation of changes designed to make monetary stabilization policy more effective, and recommendation of abandonment of short-run monetary stabilization policy in favor of creation of a stable monetary environment. In the author's own judgment, the third alternative has the most to commend it; however, if Canada remains on a fixed exchange rate the limitations on the freedom of domestic monetary policy which that entails probably will necessitate the adoption of the first alternative, or at best a mixture of the first and second alternatives. A variety of selective credit controls has been examined. Given the concentration of control in the Canadian financial system and economy, more intensive use of moral suasion might help stabilization policy, and the granting of powers to the central bank to control the more

liquid assets or loans ratio of the chartered banks might also be useful and defensible. The author, however, has a prejudice against extension of the central bank's authority in these directions, on the grounds that it involves increased dependence on the central bank's judgment of complex economic problems, and tends to support economic concentration and monopolistic practices in the financial sector and in the economy generally. Turning to controls over specific types of borrowing, a reasonably good case can be made out for empowering the central bank to fix the down-payment and repayment terms of consumer instalment-credit contracts. While an even better case could be made out for regularizing the flow of private-investment expenditure, it is extremely doubtful that capital-issues control could be used effectively for this purpose. Finally, it is in the author's judgment highly questionable whether controls on borrowing for stock-market and real-estate speculation could contribute anything significant to economic stabilization.

PUBLICATIONS OF THE  
INTERNATIONAL FINANCE SECTION

---

The International Finance Section publishes at irregular intervals papers in three series: *ESSAYS IN INTERNATIONAL FINANCE*, *PRINCETON STUDIES IN INTERNATIONAL FINANCE*, and *SPECIAL PAPERS IN INTERNATIONAL ECONOMICS*. All three of these may be ordered directly from the Section.

Single copies of the *ESSAYS* are distributed without charge to all interested persons, both here and abroad. Additional copies of any one issue may be obtained from the Section at a charge of \$0.25 a copy, payable in advance. This charge may be waived to foreign institutions of education or research.

For the *STUDIES* and *SPECIAL PAPERS* there will be a charge of \$1.00 a copy. This charge will be waived on single copies requested by persons residing abroad who find it difficult to make remittance, and on copies distributed to college and university libraries here and abroad.

Standing requests to receive new *ESSAYS* as they are issued and notices of the publication of new *STUDIES* and *SPECIAL PAPERS* will be honored. Because of frequent changes of address and the resulting waste, students will not be placed on the permanent mailing list.

The following is a complete list of the publications of the International Finance Section. The issues of the three series that are still available from the Section are marked by asterisks. Those marked by daggers are out of stock at the International Finance Section but may be obtained in zerographic reproductions (that is, looking like the originals) from University Microfilms, Inc., 313 N. First Street, Ann Arbor, Michigan.

ESSAYS IN INTERNATIONAL FINANCE

- † No. 1. Friedrich A. Lutz, *International Monetary Mechanisms: The Keynes and White Proposals*. (July 1943)
- † 2. Frank D. Graham, *Fundamentals of International Monetary Policy*. (Autumn 1943)
- † 3. Richard A. Lester, *International Aspects of Wartime Monetary Experience*. (Aug. 1944)
- † 4. Ragnar Nurkse, *Conditions of International Monetary Equilibrium*. (Spring 1945)
- † 5. Howard S. Ellis, *Bilateralism and the Future of International Trade*. (Summer 1945)
- † 6. Arthur I. Bloomfield, *The British Balance-of-Payments Problem*. (Autumn 1945)

- † 7. Frank A. Southard, Jr., Some European Currency and Exchange Experiences. (Summer 1946)
- † 8. Miroslav A. Kriz, Postwar International Lending. (Spring 1947)
- † 9. Friedrich A. Lutz, The Marshall Plan and European Economic Policy. (Spring 1948)
- † 10. Frank D. Graham, The Cause and Cure of "Dollar Shortage." (Jan. 1949)
- † 11. Horst Mendershausen, Dollar Shortage and Oil Surplus in 1949-1950. (Nov. 1950)
- † 12. Sir Arthur Salter, Foreign Investment. (Feb. 1951)
- † 13. Sir Roy Harrod, The Pound Sterling. (Feb. 1952)
- † 14. S. Herbert Frankel, Some Conceptual Aspects of International Economic Development of Underdeveloped Territories. (May 1952)
- † 15. Miroslav A. Kriz, The Price of Gold. (July 1952)
- † 16. William Diebold, Jr., The End of the I.T.O. (Oct. 1952)
- † 17. Sir Douglas Copland, Problems of the Sterling Area: With Special Reference to Australia. (Sept. 1953)
- † 18. Raymond F. Mikesell, The Emerging Pattern of International Payments. (April 1954)
- † 19. D. Gale Johnson, Agricultural Price Policy and International Trade. (June 1954)
- † 20. Ida Greaves, "The Colonial Sterling Balances." (Sept. 1954)
- † 21. Raymond Vernon, America's Foreign Trade Policy and the GATT. (Oct. 1954)
- † 22. Roger Auboin, The Bank for International Settlements, 1930-1955. (May 1955)
- † 23. Wytze Gorter, United States Merchant Marine Policies: Some International Implications. (June 1955)
- † 24. Thomas C. Schelling, International Cost-Sharing Arrangements. (Sept. 1955)
- † 25. James E. Meade, The Belgium-Luxembourg Economic Union, 1921-1939. (March 1956)
- † 26. Samuel I. Katz, Two Approaches to the Exchange-Rate Problem: The United Kingdom and Canada. (Aug. 1956)
- † 27. A. R. Conan, The Changing Pattern of International Investment in Selected Sterling Countries. (Dec. 1956)
- † 28. Fred H. Klopstock, The International Status of the Dollar. (May 1957)
- † 29. Raymond Vernon, Trade Policy in Crisis. (March 1958)
- † 30. Sir Roy Harrod, The Pound Sterling, 1951-1958. (Aug. 1958)
- † 31. Randall Hinshaw, Toward European Convertibility. (Nov. 1958)
- † 32. Francis H. Schott, The Evolution of Latin American Exchange-Rate Policies since World War II. (Jan. 1959)
- † 33. Alec Cairncross, The International Bank for Reconstruction and Development. (March 1959)
- † 34. Miroslav A. Kriz, Gold in World Monetary Affairs Today. (June 1959)
- † 35. Sir Donald MacDougall, The Dollar Problem: A Reappraisal. (Nov. 1960)
- † 36. Brian Tew, The International Monetary Fund: Its Present Role and Future Prospects. (March 1961)
- \* 37. Samuel I. Katz, Sterling Speculation and European Convertibility: 1955-1958. (Oct. 1961)
- \* 38. Boris C. Swerling, Current Issues in International Commodity Policy. (June 1962)
- \* 39. Pieter Lieftinck, Recent Trends in International Monetary Policies. (Sept. 1962)



- \* 40. Jerome L. Stein, *The Nature and Efficiency of the Foreign Exchange Market.* (Oct. 1962)
- \* 41. Friedrich A. Lutz, *The Problem of International Liquidity and the Multiple-Currency Standard.* (March 1963)
- \* 42. Sir Dennis Robertson, *A Memorandum Submitted to the Canadian Royal Commission on Banking and Finance.* (May 1963)
- \* 43. Marius W. Holtrop, *Monetary Policy in an Open Economy: Its Objections, Instruments, Limitations, and Dilemmas.* (Sept. 1963)

## PRINCETON STUDIES IN INTERNATIONAL FINANCE

- † No. 1. Friedrich A. and Vera C. Lutz, *Monetary and Foreign Exchange Policy in Italy.* (Jan. 1950)
- † 2. Eugene A. Schlesinger, *Multiple Exchange Rates and Economic Development.* (May 1952)
- † 3. Arthur I. Bloomfield, *Speculative and Flight Movements of Capital in Postwar International Finance.* (Feb. 1954)
- † 4. Merlyn N. Trued and Raymond F. Mikesell, *Postwar Bilateral Payments Agreements.* (April 1955)
- † 5. Derek Curtis Bok, *The First Three Years of the Schuman Plan.* (Dec. 1955)
- † 6. James E. Meade, *Negotiations for Benelux: An Annotated Chronicle, 1943-1956.* (March 1957)
- † 7. H. H. Liesner, *The Import Dependence of Britain and Western Germany: A Comparative Study.* (Dec. 1957)
- † 8. Raymond F. Mikesell and Jack N. Behrman, *Financing Free World Trade with the Sino-Soviet Bloc.* (Sept. 1958)
- \* 9. Marina von Neumann Whitman, *The United States Investment Guaranty Program and Private Foreign Investment.* (Dec. 1959)
- \* 10. Peter B. Kenen, *Reserve-Asset Preferences of Central Banks and Stability of the Gold-Exchange Standard.* (June 1963)
- \* 11. Arthur I. Bloomfield, *Short-Term Capital Movements under the Pre-1914 Gold Standard.* (July 1963)

## SPECIAL PAPERS IN INTERNATIONAL ECONOMICS

- \* No. 1. Gottfried Haberler, *A Survey of International Trade Theory.* (Revised edition, July 1961)
- † 2. Oskar Morgenstern, *The Validity of International Gold Movement Statistics.* (Nov. 1955)
- \* 3. Fritz Machlup, *Plans for Reform of the International Monetary System.* (Aug. 1962)
- \* 4. Egon Sohmen, *International Monetary Problems and the Foreign Exchanges.* (April 1963)
- \* 5. Walther Lederer, *The Balance on Foreign Transactions: Problems of Definition and Measurement.* (Sept. 1963)

Mr. JOHNSON. For purposes of discussion, the five bills I have read can be divided into two groups: H.R. 9686 and H.R. 9687, respectively, to provide for the payment of interest on U.S. Government deposits and reimbursement of commercial banks for services performed and to eliminate the prohibition of interest on demand deposits; and H.R. 3873, H.R. 9631, and H.R. 9685, respectively, to provide for the retirement of Federal Reserve Bank stock, to increase to 12 the number of members of the Federal Reserve Board and introduce other constitutional changes, to provide that interest received by the Federal Reserve Banks on U.S. Government obligations be covered into the Treasury as miscellaneous receipts, and to authorize appropriations for the expenses of the Federal Reserve Banks and the Board of Governors.

I approve of both groups of bills in principle, because I believe that the banking system ought to operate on competitive principles and that monetary policy should be coordinated with other economic policies under the responsibility of the elected government of the country.

The first two bills, as I understand them, are intended to restore the influence of competition in two areas of commercial banking operations in which heretofore arbitrary governmental price fixing has been the rule, in the one case to the disadvantage of the Treasury as a large depositor and in the other to the disadvantage of the private bank customer. Both changes are, in my opinion, desirable. The prohibition of interest on demand deposits was incorporated in the Banking Acts of 1933 and 1935 with the intention of inhibiting banks from engaging in as risky business as they might be tempted to do by the necessity of competing for deposit by paying interest on them. There is no a priori reason to assume that prohibition of payment of deposit interest will make banks more cautious in their lending and investment policies, nor does an exhaustive analysis of the empirical evidence bearing on this question, conducted by George J. Benston, of the University of Chicago, substantiate the claim. Moreover, the language of the Federal Reserve Act on this point—

No member bank shall, directly or indirectly, by any device whatsoever, pay any interest on any deposit which is payable on demand—

is virtually unenforceable and evidently not enforced; the effect of the prohibition has been to lead banks to compete by other devices ranging from free checking and other services through variable compensating balance requirements on bank loans to the offer of various gifts, methods of competition which are socially wasteful and likely to have regressive effects on the distribution of income. Not only should the prohibition of interest payments on demand deposits be terminated, but so should the powers of the Reserve Board and the FDIC to control interest rates on time deposits, which equally serve no useful social purpose. According to the same logic of efficiency in a competitive economy, the Treasury should receive the market rate of interest on its deposits with the banks, and pay reasonable service charges to the banks to cover the costs to the latter of managing the deposits, rather than simply canceling the one against the other as is the present practice.

The three bills in the other group aim at fundamental constitutional changes. H.R. 3783 would recognize that the original conception of the Federal Reserve System as an institution for reserve pooling by members has long been a mere fiction, the function of the system now

being largely to control the volume of deposits in pursuit of economic policy objectives. It would also facilitate monetary control by somewhat reducing the burden of membership on member banks and so encouraging widespread membership in the system. This conclusion assumes that 6 percent is below the normal yield in bank capital.

H.R. 9685 would have the effect of subjecting the Federal Reserve System's expenditures to congressional control, by obliging the system to seek appropriations instead of expending as much as it sees fit of the healthy profits earned from the interest-free issue of notes and reserve deposits against interest-bearing Government debt before turning the residue over to the Treasury. I must confess to mixed feelings about this proposal. On the one hand, one senses a certain atmosphere of freedom from financial restraint in the way the Federal Reserve System staffs itself and issues its publications; and there is the remote possibility, exemplified by the 1961 dispute in Canada between the Governor of the Bank of Canada and the Minister of Finance, that the Federal Reserve might use the funds at its disposal to propagandize the public on its own behalf in a policy dispute.

On the other hand, there is a strong tendency, here and elsewhere, for legislators to insist on underpaying their top civil servants, to the detriment of the quality of the service and the efficient performance of public business; while congressional control of appropriations sometimes permit the hounding of public officials and inquisition into the detailed conduct of public business to no apparently useful purpose.

H.R. 9631 is obviously the most important of the five bills, since its effect would be to transfer control of monetary policy to the Administration, provide constitutionally for the coordination of monetary, fiscal, and debt-management policy, and render the Federal Reserve System financially accountable to Congress. As indicated by the general argument of the preceding section, I am in favor of the objectives of this legislation, and particularly of the coordination of monetary, fiscal, and debt-management policy through the appointment of the Secretary of the Treasury as *ex officio* Chairman of the Federal Reserve Board.

The past history of the relations between the Treasury and the Federal Reserve contains numerous examples of conflicts between these facets of economic policy, conflicts of which it cannot be said that either party was always espousing policies consistent with economic stability; and it would contribute to the efficiency of economic policy for these conflicts to be reconciled in the formulation of policy rather than erupt in the execution of inconsistent policies. Such provision for the coordination of monetary and fiscal policy is especially necessary under present circumstances, when the pursuit of domestic objectives must be reconciled with restoring equilibrium in the balance of payments.

The bill does, however, contain a variety of detailed provisions which may or may not constitute the best method of achieving the general objective of the legislation, but on whose merits I am not competent to judge. I might mention, however, that I have some reservations about the usefulness and functions of the Federal Advisory Committee: it seems to me that a body of 50 assorted members, appointed for a term of 1 year and meeting only occasionally, might constitute a helpful source of information about the various sectors of the economy and a sounding board for ideas originating in the Federal

Reserve Board, but could hardly acquire the knowledge of policy problems and the internal cohesion required to fulfill the initiatory role envisaged for it in the bill.

I shall confine my comments on recent monetary policy to a few brief remarks.

Monetary policy since 1957 displays the pattern of overreaction followed by excessively sharp reversal to which I have referred in a previous section; in addition, it displays the increasing subordination of domestic objectives to balance-of-payments objectives that is the necessary consequence of the weak international position of the dollar. I shall not document this assertion by a detailed chronicle of monetary policy, since other presentations before this committee will have done so or will do so; but I would like to call attention to the contractions of the money supply—currency plus demand deposits, seasonally adjusted—from July 1959 to June 1960 and from January to August 1962, whose severity, given the prevailing conditions of undesirably high unemployment, was undoubtedly motivated by concern about outflows of gold, and to the slow rate of increase of the money supply—in relation to the longrun historical average—in the first half of 1963 and the slight contraction in the period June to August, which were associated with an adverse turn of the balance of payments and the danger of a capital outflow. These restrictive episodes in each case were followed by recession or a slowing down of the rate of expansion, in which they undoubtedly played some casual role.

Over the period from December 1960 to December 1963 the money supply has increased at an annual average rate of 2.9 percent, a rate well below the longrun historical average for the economy, and this low rate of increase, which must I think be attributed ultimately to concern over the balance-of-payments problem, has clearly played a part in inhibiting the achievement of satisfactory levels of activity and employment. Since August 1963 the money supply has been increasing at a much faster rate—a 6.2-percent annual rate for the month ending December 15. This change to a more expansionary policy I interpret as having been made possible by the elbowroom provided by the rise in short rates in mid-1963, the influence of the proposed interest equalization tax on foreign borrowing in the United States, and, I suspect, agreement on the part of the European countries to help to support the dollar through several more years of deficit and their acquiescence in a U.S. policy of domestic expansion; but the expansion that has actually occurred I would attribute to a policy of attempting to prevent interest rates from increasing further, at a time when demand was expanding, in part under the influence of past and prospective tax reductions.

The change to a higher level of short-term interest rates, made necessary by the danger of capital flight, was accompanied by a renewed announcement of the policy of tilting the yield curve so as to prevent or inhibit increases in long-term rates. The possibility of achieving divergent movements of short and long rates by monetary policy seems to me, on the evidence of recent economic research on the term structure of the public debt and its sensitivity to changes in the maturity composition, extremely limited; and long rates have in fact been following short rates upward.

Some analysts would regard the upward movement of long rates as portending a slackening or decline of economic activity. I am not sure on this point. For one thing, the investment credits and provision for accelerated depreciation will have increased the private rate of return on investment projects to which they apply, and so made a given level of long rates less restrictive than it would have been before these tax changes; for another, the expansionary effect of the impending tax cut, combined with continued monetary expansion, would permit long rates to rise consistently with economic expansion. The balance-of-payments situation and the commitment to the present value of the dollar in fact oblige the economic policy authorities to adopt a policy combination that expands domestic demand and activity while raising interest rates sufficiently to improve, or at least prevent a serious deterioration of, the capital accounts of the balance of payments.

As I have mentioned, recent monetary policy exemplifies not only the growing subordination of monetary policy to the balance of payments problem but the pattern of overreaction to economic change followed by excessively sharp reversal of policy characteristic of discretionary monetary policy as currently practiced. This pattern is, in my judgment, attributable to the concentration of the Federal Reserve on money market conditions, interest rates, and member bank reserve positions as the objects of monetary rates, and member bank reserve positions as the objects of monetary control.

While I have expressed reservations about the desirability of a rigid rule of monetary expansion as a specification of a proper monetary policy, it seems to me that the performance of the Federal Reserve as an agency of economic stabilization would be considerably improved if it were to devote less attention to monetary and banking conditions and more to the effects of its policy actions on the quantity of money and its rate of change. Thank you.

The CHAIRMAN. Thank you, Professor Johnson. Now we will hear from Professor Villard. You may proceed in your own way.

#### **STATEMENT OF PROF. HENRY H. VILLARD, COLLEGE OF THE CITY OF NEW YORK**

Mr. VILLARD. Thank you, Mr. Chairman. I am Henry H. Villard, chairman of the Department of Economics of City College.

As I see it, the basic problem that we face is that when the economy is close to full employment, we are faced with the necessity of choosing among alternatives. It is this which we have not yet learned to do.

The alternatives I have primarily in mind are employment and growth on the one hand, and inflation and balance-of-payment difficulties on the other. In my opinion, as the level of total spending in the economy is increased to reduce unemployment, we will typically increase the rate at which additional compensation is likely to be demanded by the factors of production and the resulting increase in prices can usually be expected to increase our balance-of-payment difficulties.

For, as I see the matter, if I may be permitted to reduce a by-no-means-simple problem to its barest essentials, we have fundamentally to determine what it is now fashionable to call the proper "trade off" between employment and inflation. On this matter I happen to have some rather strong opinions. For my guess is that a more expansion-

ary monetary and fiscal policy might well reduce unemployment by not less than 2 percent of the labor force, or one-third of the present level, and that the resulting increase in output—because of the concomitant reduction in on-the-job unemployment—might well increase the national income by not less than 5 or 6 percent—or by at least \$25 billion. On the other hand, because I believe that recent increases in prices stem mainly from the administered character of much of our present pricing of the factors of production—often referred to as the “cost push”—and are, therefore, substantially independent of the “demand pull” induced by additional spending, I rather doubt that a 5- or 6-percent increase in the national income would raise the rate of increase in consumer prices from the 1.25 percent that we have averaged over the last 5 years to much over 2 percent. Once again to put a quite complicated matter in the baldest possible terms, as I see it, in order to reduce the rate of increase in prices by hardly more than 1 percent a year we have recently been wasting perhaps 5 percent of our productive potential. When I take into account that continuing unemployment has caused labor leaders to question seriously the value of automation and is turning many of the unemployed into unemployables, I find what I estimate to be the recent “trade off” between unemployment and inflation a very poor bargain indeed.

What I have just presented are guesses with which many able economists will strongly disagree. I am least interested in trying to persuade you to accept my particular estimate of the “trade off,” which may or may not be right. What I am very much interested in stressing is that a decision is currently being made—and being made more by omission than commission. For at present the overall decision is the result of an unplanned amalgam of substantially independent decisions by the Federal Reserve System in regard to monetary policy, by the Treasury and the Congress in regard to fiscal policy, by the Council of Economic Advisers when it suggests guidelines on desirable price increases—and by everyone in the economy in a position to administer prices. Thus, as I see the matter, we are in regard to overall economic policy in a situation quite similar to where we were in regard to security policy not so long ago, and I offer the thought that the solution may well be similar: the establishment of a National Economic Council to include representatives of the Federal Reserve System, the Treasury, the Council of Economic Advisers, and other interested Government agencies.

This is obviously not the place to spell out in detail the way in which a National Economic Council should operate, but there are two thoughts I would like to offer. First, I conceive of the Council, in relation to the President, as having a primary advisory and coordinating role. For in my judgment—paraphrasing Clemenceau—overall economic policy is too important a matter to be left to economists or bankers, to the extent that the Congress can be persuaded to delegate its constitutional powers, they should be delegated to no one less than the President.

Second, I urge in the strongest possible terms that the Congress delegate more operating responsibility for economic policy to the President. Under the Constitution, power over both the money supply—or monetary policy—and taxes and expenditures—which together constitute fiscal policy—is vested in the Congress. Fifty years ago operating control over monetary policy was wisely delegated by the

Congress to the Federal Reserve System. But thus far the Congress has been completely unwilling to make any significant delegation of its powers over expenditures and taxes. I believe what is most needed today—and is far more important than any possible change in the Federal Reserve arrangements—is for the Congress to delegate to the President, and through him to the Council, the power to vary, within limits carefully specified by the Congress, rates of expenditures and taxation. For the Congress cannot effectively concern itself with the day-to-day operation of the economy.

I take it that the immediate concern of this committee is how well the 50-year-old delegation of short-term control over monetary policy to an independent Federal Reserve System is working. I have two somewhat contradictory thoughts on the matter. On the one hand, I think there is likely to be general agreement that arrangements to isolate the Reserve System from undue influence by bankers or by the Secretary of the Treasury in pursuit of low interest rates are both desirable and have by and large been successful. Thus I am not in favor of efforts to increase the influence of the Secretary of the Treasury over the system or, for that matter, the influence of the Congress. On the other hand, I am strongly in favor of arrangements which would insure the coordination of monetary policy with general economic policy as determined by a National Economic Council. This means that, in the event of irreconcilable conflict, I would favor subordinating the System to the President, operating through a council such as I have proposed.

If, under such delegation, the President were to abuse his powers, say to obtain low interest rates for the Treasury, the electorate would then know whom to hold accountable for any subsequent inflation. In short, I am prepared to compromise the independence of the Reserve System in order to achieve overall coordination of economic policy. But my regard for the quality of those heading the System is such that I would be inclined, before making drastic changes, to see whether the coordination of monetary policy with general economic policy could not be achieved by persuasion rather than compulsion.

On the specific bills I find myself in close agreement with Professor Harold Barger, of Columbia University, who is scheduled to appear before you on March 10.

I have seen his statement although he has not yet appeared before you.

First, I share his conclusion that, because of the importance of membership in the Reserve System, H.R. 3783 should not be enacted unless coupled with a measure to require all commercial banks to become members of the system. Again I share with Professor Barger his conclusion that it would be undesirable to increase the size of the Board, include the Secretary of the Treasury, or expand the size of the Federal Advisory Committee.

I further agree with him on the desirability of abolishing the Open Market Committee and obviously on the need to achieve coordination of monetary and general economic policy though I am less certain than he is as to how best this can be done in the absence of a National Economic Council. Finally, I feel as does he that audit by the General Accounting Office is not needed. I am not clear as to whether the pur-

pose of the proposed audit is to uncover possible waste or subject the system to more congressional pressure. I feel certain the waste, if any, is trivial, so that I would oppose an audit for this purpose unless perhaps GAO audits are applied uniformly to all Government expenditures, including those of congressional committees. As I have already made clear that I do not believe that the Congress is well equipped to make short-run decisions on economic policy in general or monetary policy in particular, I am also opposed to more congressional pressure on the system either indirectly through a GAO audit or directly by insisting on annual appropriations, as is provided in H.R. 9685.

On the remaining bills before you I continue to find myself in agreement with Professor Barger. I approve in principle of H.R. 9686, providing for the payment of interest on Treasury deposits with offsetting compensation for banking services rendered the Treasury; my only reservation is whether enough is involved to justify the book-keeping that would be required. I see no reason why, if economically justified on a competitive basis, interest should not be paid on demand deposits, as permitted by H.R. 9687. And I support the Kilburn-Robertson bill—H.R. 8505—to eliminate the penalty rate on discounts secured by ineligible paper, as proposed by the Reserve System.

I have saved H.R. 9749, which requires the Reserve System to make sure that the yield on Federal bonds does not rise above 4.25 percent, for final comment because it seems to me to epitomize the problems we face. For we are all in favor of the Government borrowing at reasonable cost and we are all opposed to inflation. But, most unfortunately, there are times when these two objectives are contradictory: should market conditions cause the price of Federal bonds to decline to the point at which they yield more than 4.25 percent, all that the Reserve System can do to support bond prices is to create additional money, which will in turn typically add to inflationary pressures. It seems to me that the choice between higher interest costs and inflation can only be made as a part of overall economic policy—which is something that, within the delegated range, I believe the President should decide with the help council I have proposed. In my judgment for the Congress to mandate by statute a particular interest rate regardless of all other considerations makes no sense whatsoever. Thank you.

The CHAIRMAN. Thank you, Professor Villard. I would like to ask you specifically about these bills and these will just be a few questions in order to make the questioning short.

Now, about the one to retire the so-called Federal Reserve Bank stock, would you favor that, Professor Johnson?

Mr. JOHNSON. Yes, sir; I would.

The CHAIRMAN. You would favor that?

Mr. JOHNSON. Yes.

The CHAIRMAN. What about you, Professor Villard?

Mr. VILLARD. Only if it were accompanied by some effort to compensate the banks for the loss of profitability. I would not like to see the attractiveness of the Reserve System reduced by the measure. Otherwise, I have no objection to it.

The CHAIRMAN. Do you not think the fact that they get their checks cleared free of charge would be a sufficient attraction to stay in the system? You know that costs the Government about \$125 million-plus a year.



Mr. VILLARD. Well, it does not seem to have been an adequate attraction to bring all banks into the system.

The CHAIRMAN. Nonmembers get it through their corresponding banks, you know.

Mr. VILLARD. I realize that——

The CHAIRMAN. Suppose we were to change the law, so that they could get their checks cleared only if they belonged to the system?

Mr. VILLARD. Well, any device which gives us a coordinated monetary system is one that I favor.

I do not strongly object to the repealing of—the retiring of the stock. It does seem to me though it should be viewed as part of the overall organization of the system.

The CHAIRMAN. You look upon it as an attraction?

Mr. VILLARD. This is what I understood from, I believe, Mr. Martin's testimony, that he felt it was an attraction. I do not really know which way it is.

The CHAIRMAN. Now, do you believe, Professor Johnson, that we should take the representatives of the banks off of the Open Market Committee? In other words, make it strictly a committee or a board composed of people who are public servants representing the public only?

Mr. JOHNSON. My answer to that question, sir, is "Yes."

The CHAIRMAN. You favor that?

Mr. JOHNSON. Yes.

The CHAIRMAN. What do you think about it, Professor Villard?

Mr. VILLARD. I also favor it, sir.

The CHAIRMAN. Yes, sir. Now, the next one is about having the Federal Reserve turn over to the Treasury the interest on its holdings of Government securities and get its appropriation from Congress. Would you favor that, Professor Johnson?

Mr. JOHNSON. I would be in favor of it, sir, though I do not know quite how much there is in it.

The CHAIRMAN. What about you, Professor Villard?

Mr. VILLARD. I would have some reservations. In fact, I think I am opposed to it.

Let us say that I do not think it is desirable for the Reserve System to have to come to the Congress for annual appropriations. This is simply part of my feeling that the Congress should not be in a position to apply pressure on day-to-day decisions of the monetary authority.

The CHAIRMAN. Yes, sir. Now, I would like to ask each of you gentlemen this: when the Open Market Committee buys Government bonds, and it now has approximately \$34 billion worth, the Open Market Committee, in effect, trades Federal Reserve notes, currency, money, for these Government obligations. In other words, it transfers one Government obligation for another Government obligation.

Do you think that those obligations that are bought with Government money should remain outstanding and the taxpayers should be compelled to pay interest on them when they, in effect, have been paid for once by the transfer? What do you think about that, Professor Johnson?

Mr. JOHNSON. I have a little difficulty getting used to that way of looking at it, sir.

The point of open market operations is to influence the economy by changing the proportions of interest-bearing debts, and deposits of the Federal Reserve and currency, in the hands of the public.

If the amount of money outstanding increases and the amount of debt in the hands of the public decreases this means that the Government (taking the Federal Reserve and the Treasury together) has less interest to pay. My understanding is present arrangements do provide for the return of surplus—

The CHAIRMAN. Yes, sir, that is correct.

Mr. JOHNSON (continuing). To the Treasury.

The CHAIRMAN. Yes. I will not pursue that point because it would involve quite a bit of discussion and more time than I am allowed at this time. So if I want to pursue it I will do it later on. I see your point all right.

But I think the point is reached where these outstanding bonds are not needed; \$34 billion certainly is not needed for open market operations. A much smaller percentage could be used that would suffice for the reasons that you just stated which, of course, are valid reasons, I recognize that.

Mr. JOHNSON. Well, I would like to put this point, Mr. Chairman: In fact, we create a lot of technical difficulties with monetary management by having the Treasury issue the debt as a gross total and then have the Federal Reserve buy and hold some of it in order to alter the composition outstanding among the public.

If we look at the Government operations as a whole, it might facilitate matters if the Federal Reserve was able to issue interest-bearing obligations instead of having to buy and sell Government bonds.

The CHAIRMAN. I see. Do you favor, Professor Johnson, the General Accounting Office auditing the Federal Reserve System?

Mr. JOHNSON. Sir, that is a matter on which I do not have an opinion because I do not know the details of the organization.

The CHAIRMAN. Would you favor that, Professor Villard?

Mr. VILLARD. No, I do not believe I would, sir. I do not think it would serve any particularly useful purpose.

The CHAIRMAN. Now, how do you gentlemen feel about eliminating the prohibition against the payment of interest on demand deposits?

Professor Johnson, how do you feel about that?

Mr. JOHNSON. I am all in favor of that, sir, and I would like to extend it to the elimination of all restrictions on time deposits.

The CHAIRMAN. How do you feel about that, Professor Villard?

Mr. VILLARD. I feel exactly the same way.

The CHAIRMAN. Now, how do you feel about these funds going into the banks, private banks, and what is known as the tax and loan accounts?

First, do you believe it is necessary to have those tax and loan accounts at all? You know, the bankers are putting up an awful fight, claiming that they are losing money all the time.

I have never known people to fight so hard to keep on losing money, but they claim they are losing money. Do you feel that they should pay interest on the difference between what it actually costs them and what the account is worth to them, Professor Johnson?

Mr. JOHNSON. Well, in my statement I argue in favor of the payment of interest and the payment of compensation for services.

However, Professor Villard has raised one question as to how far this amount of accounting is worthwhile, and that is obviously a factual question.

In principle I am in favor of interest being paid on loans and charges being made for bank services rather than mixing them up together in one bundle in the hope that one will compensate the other.

The CHAIRMAN. I will yield to Mr. Brock.

Mr. BROCK. Thank you, Mr. Chairman.

Mr. JOHNSON, I did not quite understand this. Would you say once again what your feeling was to 9749, which would amend the Federal Reserve Act to provide for a ceiling on Government bonds?

Mr. JOHNSON. I am sorry, Mr. Brock, but I was not given a copy of that bill and unless you press me on it I had rather not express a judgment on it. If you press me, I will.

Mr. BROCK. Well, in general, could we put it this way: Do you think it is wise for the Congress to enact legislation putting a limit on the amount of interest or the yield of Federal Government bonds?

Mr. JOHNSON. No, I do not think that would be wise because what constitutes a high interest rate or a low interest rate varies from time to time and, under present circumstances, as I mentioned indirectly in my paper, the current interest rates may well be low.

Given the tax incentive to business investment and so forth they may be low, whereas in the past they would have been extremely high.

I do not feel that we can predict what a reasonable level of interest rates will be. I agree with the intention of helping to minimize the cost of public finance, but I do not think that it is appropriate to try to do that by fixing a ceiling on the interest rate on Government debt.

Mr. BROCK. In other words, if I follow you through with this thought, it is possible, as Professor Villard has stated or has indicated at least, that if you put a ceiling on Government bonds then you could increase the inflationary tendencies which were already inherent in the rising market?

Mr. JOHNSON. Suppose we have a situation like this: Suppose that for one reason or other the profitability of investment gets extremely high. We then find that interest rates tend to drift up to that 4.25 percent ceiling because of the pressure of the demand for funds.

To legislate that the Federal Reserve must keep the interest rate at that level means, in effect, that it is obliged to buy all the bonds offered to it.

Now, this would involve the creation of money which might contribute greatly to inflationary pressure, and I feel that if you want to make a choice between low interest costs on the Government debt and resisting inflation you should be free to do that in light of the circumstances at the time.

Since this legislation is intended to be a permanent feature of the system we cannot tell whether it will prove a serious obstacle to the policy or whether, conversely, it might prove completely ineffective.

Suppose, for example, the opposite situation existed, where interest rates were low, this restriction would be meaningless and contribute nothing to cheap Government financing which, I understand, is the main motive of the bill.

Mr. BROCK. Well, the main motive of the bill is cheap Government financing, perhaps, but also it is, as I understand it, to insure that the people in the country get a reasonable rate of interest——

The CHAIRMAN. A reasonable rate of what?

Mr. BROCK. Cheaper money.

The CHAIRMAN. I think there is a difference between the cost that the Government should pay for interest and what the economy in general should pay for interest.

I do not think the Government should pay as much because it is the Government's credit that is used to create money, and I think the Government's interest rate, if it was left up to me, that is, I would make it around 3 percent and hold it there.

Mr. BROCK. Well, what——

Mr. CHAIRMAN. And the Fed can do that if they want to. They can make it 2.99 or 3.01, and hold it right there if they want to, and they have.

Mr. BROCK. That is right.

Is it not true, Mr. Johnson, that if we were to adopt such a policy of a fixed maximum on the yield that—let's take your initial illustration, where we had a strong inflationary tendency within the country, and we were trying to save the Government money on this, we could raise the cost to the individual American citizen quite considerably through inflation not only in its borrowing but in all prices, and thereby create a situation where you would have done quite a lot of damage to the economy as a whole. Is that not true?

Mr. JOHNSON. I find it difficult to sort out the different ideas involved in your statement, sir.

The effect of a ceiling of this kind under inflationary conditions would be that the Federal Reserve System would be involved in buying Government debt in exchange for the creation of money. In effect, what would happen would be that the Government would be saving not so much because it was getting low interest rates but because interest-bearing debt was being turned into currency by people who did not want to hold it at that low interest rate.

This, in turn, would mean inflationary conditions. It would not necessarily be effective at all in holding down interest costs on private borrowing.

Mr. BROCK. It might be the reverse, might it not?

Mr. JOHNSON. Initially, yes. It would depend on how fast the Federal Reserve bought the debt, but it would mean, in effect, that you were depriving yourself of the use of monetary policy to help to curb the inflation.

And this would seem to me undesirable in principle. So far as the Government financing costs are concerned the Government does get a better rate than people in general precisely because it is the Government.

If one wants to reduce the cost of public debt to the Government then one might think of all sorts of ways of doing this, for example, raising reserve requirements on banks which would mean automatically that they would have to hold larger reserve deposits which, in turn, would mean that the Federal Reserve would hold the Government debt and the interest on that would go back to the Treasury.

There are many ways of doing this if that is what you want to do, but I would not like to see the hands of the monetary policy-makers tied by an obligation to maintain an interest rate which was chosen without any regard to the circumstances in which they might find themselves.

Mr. BROCK. If we had adopted a national policy of stable prices and economic growth and full employment, which are all admirable goals, and we had this interest ceiling at the same time that we had inflationary pressures, might it not be required for the Congress to enact legislation to hold prices at a certain level, in other words, price and wage controls, in order to—

Mr. JOHNSON. Well, this is carrying the argument a step further.

First of all, you debar yourself from using monetary policy to stop the inflation and then you try to stop it by controlling prices, but attempting to stop an inflation by controlling prices, while you continue to expand the money supply, is an attempt to doctor the symptoms and not the disease itself, and it is very likely if that went on very long people would find ways of dodging and you would get all the problems you get when money ceases to be trusted.

People resort to other means of exchange and generally the economy becomes very inefficient.

Mr. BROCK. Is not this really—although I think the conditions justify the situation, but is it not true that this basically is what happened during World War II, when we had tremendous demands, tremendous money, and yet we had price controls?

Is it not illustrated by, or the problems involved illustrated by, what happened after World War II, when we took off the wage and price controls and we left the ceiling on the Government bonds and we had a tremendous surge in prices, some 70 percent, in—

Mr. JOHNSON. That is right, but you have to be careful there because to some extent the manifestations of higher prices were already present but obscured by the controls.

It was not simply that everything was going nicely and then you took off the price ceilings and trouble began. The trouble was piling up behind those price controls.

But this illustrates a point I made in my statement, incidentally, that at the time when a restrictive monetary policy is desirable to stop the inflation in fact you did not have such a policy. You had a low-interest-rate policy during the war which did contribute to the subsequent inflation.

Mr. BROCK. Both of you commented on, to a limited degree, the provisions which would authorize the appropriations process rather than the present procedure of a Fed taking interest from Government obligations.

Would you comment, Mr. Villard, or Professor Villard, on what effect it would have on our money supply if the Federal Reserve were prohibited from taking these Government bonds?

In other words, if these \$33 or \$34 billion were not held by the Fed but had to be sold to the general public what effect would that have?

Mr. VILLARD. Well, it is a bit hard to answer in the abstract, in the sense that it is conceivable that one could change arrangements so that the effect would depend on the arrangements that one made to compensate for the sale.

But is your question in terms of general sale or recapture of the interest on these bonds? It seems to me——

Mr. BROCK. No, it is not related to the interest so much as it is to the money supply.

In other words, when these bonds are purchased by the Federal Reserve they are put in actually—actually, they are credited—a deposit is credited from which you can expand the money and——

Mr. VILLARD. Obviously they could not be sold to the general public without decreasing the money supply.

An open-market operation consists of buying or selling Government bonds and an open-market sale means decreasing the money supply. Any program of just selling bonds to the general public would cause a drastic decline in the money supply.

Mr. JOHNSON. May I comment on that, sir?

Mr. BROCK. Yes.

Mr. JOHNSON. The question is whether you think of getting rid of these Government bonds, retaining the present reserve ratio or not.

If you assume the reserve ratio to be stable and you sell the bonds, it would involve a drastic contraction of the money supply and increase the interest rates on Government debt and, in general, would have adverse effects on both the economy and the Treasury.

However, you could contemplate, in going about this, another way which would be to combine the sale of the bonds with a reduction in reserve ratios. This, in effect, has been the general trend of Federal Reserve policy in the postwar period, to expand the money supply to meet the needs of growth by reducing reserve requirements.

The effect of this has been that the public has held the bonds rather than the Federal Reserve. And one might argue that this is desirable.

Certainly, the banks would argue that it is desirable to have lower reserve ratios and let them hold the bonds. But the consequences for the cost of the debt would tend to be to raise it because the fact that the Federal Reserve holds only Government bonds, or mostly Government bonds, means that when money or assets are held by them it goes into the Government debt, whereas when the banks have the disposal of the money the Government debt must compete with private debt.

I cannot quite see the objective from which you are exploring this particular proposal. One could, if one were worried about the interest cost only, simply convert a large block of Federal Reserve holdings of interest-paying debt into non-interest-bearing debt.

This would be a perfectly feasible change and would involve no monetary consequences. It would only affect the allocation of the interest received on Government debt between two branches of Government.

Mr. VILLARD. But might I comment that inasmuch as the earning of the Federal Reserve System, over and above its expenses, go back to the Government it does not make too much difference what one does at the margin in regard to the \$33 billion that the System holds.

If it holds more it simply means it will return more to the Government so long as the amount of its expenditures are set. So it does not seem to me that converting the debt one way or the other is of any particular significance.

Mr. BROCK. Well, may I proceed with this for 1 more second?

The CHAIRMAN. Yes.

Mr. BROCK. Well, if this is the case then you, I think, Professor Villard, argued against the appropriation process, but if we were to not pay interest to the Fed on this \$33 billion, in effect, do you not have to go to the appropriation process?

Mr. VILLARD. You very definitely do, but what I am really saying is that it does not make any difference what you do over and above that portion of the debt which compensates for the cost of operating the Federal Reserve System. That goes back to the Treasury in any event, so that making, for example, part of the debt held by the Federal Reserve System noninterest bearing would not change the picture.

The appropriation matter is, of course, the same question as to whether you believe the monetary authority should have to come in annually for an appropriation from the Congress.

There is a case for it, but I do not feel that this is a desirable change, or that they have in fact misused the money even though it is substantially without any close control, or that they have used it in an inappropriate fashion.

Mr. BROCK. My time has expired. Thank you.

The CHAIRMAN. Mr. REUSS.

Mr. REUSS. Thank you, Mr. Chairman.

Pursuing just briefly the point that you have been discussing with Mr. Brock, you gentlemen have suggested that if Congress, by law, required paying off the bond at  $4\frac{1}{4}$  percent or at any other fixed percentage, if we then got to full employment or something near it, there would be an increase in the money supply unrelated to the needs of the economy which might well be inflationary.

Could not that evil day be somewhat postponed at least by taking compensatory action with respect to the legal bank reserve requirements—that is to say, if Congress passed such a law?

I have some reservation at the moment as to whether it should, but could not the possible inflationary effects of that be deadened, or at least postponed, by Federal Reserve policy of raising the reserve requirements of the banking system?

Would you not be able to peg the price somewhat longer without getting into inflationary problems?

Mr. JOHNSON. I would comment as follows, that it is obviously possible to reduce the cost of the Government debt by obliging the Federal Reserve or the banking system as a whole to hold more of it.

In fact, that was one of the arguments for secondary reserve requirements that have been with us since the war.

That, I think, would be a more feasible way of pursuing the objective of lowering Government interest cost; that is, requiring a part of the market to hold the debt even though it involves a lower return on their money than they could get elsewhere without imposing an interest rate ceiling.

I think, if that is the objective, it would be better to pursue it by creating an artificial market.

It is true that if you fixed the price you could mop up some of the inflationary consequences at least in the short run by forcing the banks to hold a larger and larger portion of it or, as you suggest—

Mr. REUSS. Or the Federal Reserve?

Mr. JOHNSON. Or the Federal Reserve—increase the reserve requirements so that banks have to hold more deposits in the Federal Reserve and thereby enable the Federal Reserve to hold more of the public debt without having a general expansion of credit to the public. That is true.

But it would involve, in effect, imposing a tax on the banks. The obligation to hold higher reserves is an obligation on the banks to forgo yielding assets—

Mr. REUSS. By sterilizing some of their bank assets?

Mr. JOHNSON. Yes; and in the longer run this might mean that banks were seriously impeded in competition with other financial institutions so that you would be eroding the base of monetary control by forcing the economy to develop alternatives to banking as a means of providing the banking services.

If you reduce the profits of banking, obviously you tend to make banking services be provided in some other way.

Mr. VILLARD. Might I comment that I think that the strongest objection that I would have is to the inflexibility involved in it.

I do not dispute the point that you have raised, that there is a range over which—as Professor Johnson just stated—it is possible to offset inflationary effects.

But I would think it would be most undesirable to mandate a matter of this sort by congressional action once and for all; it should be something that is possible to vary as conditions vary.

Mr. REUSS. Going on to a related point, what do you gentlemen have to say about the present ability of the Federal Reserve money managers to control the money and credit of the country?

What the Federal does control, is, if I am not mistaken, a very much smaller figure than the total of savings and loan deposit certificates and various other pieces of paper put out by financial intermediaries.

Do either of you have anything to say on the general question of whether the Federal Reserve may not, in fact, and with the best will in the world be kidding itself and the public about its ability to—

Mr. JOHNSON. Well, Congressman, the fact that the Federal Reserve directly controls only bank credit is not essential because as long as the rest of the system responds to the changes in the base of bank credit the existence of other institutions gives more leverage, rather than less, over the economy.

Now, there has been a great deal of dispute among economists in the past 7 or 8 years over whether the presence of these other intermediaries makes a difference or not, and so far as my best judgment goes, there is not that much change in the economy or substitution of one type of liability for another, and so forth, so that the Federal Reserve does not have all the power it needs through its control of money supply.

Mr. VILLARD. This would also be my opinion.

I would say that there have been changes but they are not of the magnitude or sort that significantly reduce the power of the Federal Reserve to control monetary matters.

Mr. REUSS. Another question: Can you gentlemen think of any way in which we could differentiate between the uses to which credit is put?

I will give you an example of what I mean. In the present state of the economy, with 5-plus percent unemployment, underuse of re-



sources, and so on, we obviously need credit, bank credit and other forms of credit, to enable businessmen to erect new plants, buy equipment, and other capital goods the very creation of which will itself make jobs.

Therefore, if a bank loan is made for that purpose that is fine. If, however, a bank loan is made for the purpose of enabling me to bid up the price on a piece of downtown real estate over here in one of the suburbs I would not think that was particularly good. That does not put anybody to work. It simply adds to the cost of the economy, makes somebody a windfall profit, and so on. Is there any way known to man in which we can steer things in one direction or the other?

What I am getting at, really, is that I would like lots of credit at low interest rates for productive purposes, but I wish there was some way of providing that without at the same time creating too much speculative activity in the stock market, in real estate, and so on.

Mr. JOHNSON. Well, Congressman, I have dealt with these issues at considerable length in the document I have circulated, which I prepared for the Canadian Royal Commission.

The answer that I arrived at is that money is an anonymous material and nobody can tell what it will be used for, so that efforts to prevent lending for one purpose and to favor lending for another purpose are very easily evaded.

So they tend to be pretty useless.

Also it is very difficult to tell just what is a productive purpose and what is not. Take the real estate transaction that you are talking about: It is quite possible that a purchase of a piece of land may be preliminary to the development of a subdivision, and it is impossible, in my judgment, to tell whether such things are speculative or not.

They are speculative in one sense, that they look toward future profits, but they may be looking toward employment and—

Mr. REUSS. If I may interrupt you; of course, if it is the first step in the production of a development of a subdivision, that is fine. If, however, it is merely a change in a 1926 Florida land transaction, then it is bad and not good. As you say, you cannot tell the difference, but—

Mr. JOHNSON. Well, I do not think it is possible to tell the difference, at least until afterwards, which is too late.

I do not think you can devise legislative rules or operating rules which will enable you to discriminate in this fashion. We do have, in our society, a bias against speculators.

Everybody resents seeing somebody make money apparently for nothing.

On the other hand, an exercise of judgment about the future often involves just this kind of activity. It may be also that our tax system gives an unfair advantage to those who operate in that kind of transaction by enabling them to get capital gains treatment, and so forth, but this seems to me to be a question for the tax system rather than the credit mechanism.

Where taxes create incentives for people to play for capital gains or take advantage of the special laws, that is a fault of the tax system, and I do not think it is possible to combat that by the way you conduct credit policy.

Mr. VILLARD. May I comment that it seems to me that it is not merely a question of the distinction between speculation and productive credit. It seems to me that the real problem is more fundamental.

As I suggested in my statement, if one wants to obtain full utilization of resources, then there is almost certainly going to be greater pressure on prices. This is a characteristic of our economy, it seems to me.

And there is no way that I can see that, on the credit side or even adding fiscal policy, that you can avoid the necessity of having to choose between a higher level of spending which, in turn, is essential for a higher level of employment, on the one hand, and the pressure that it leads to for the prices of the factors of production to rise more rapidly.

What I mean concretely, to take the most important factor of production—labor—is that as the economy moves toward full employment, and profits become high, the labor movement feels that it should push harder for wage increases which, in turn, means more rapid price increases.

It is because of the need to choose between these that I urge the establishment of some mechanism for the coordination of overall economic policy.

Mr. REUSS. Thank you.

The CHAIRMAN. Mr. Hanna.

Mr. HANNA. Thank you, Mr. Chairman.

As I gather from your statements, gentlemen, both of you would agree that the functions now carried on by the Open Market Committee could be carried on through some other mechanism. Is that true?

Mr. JOHNSON. Yes.

Mr. VILLARD. That is correct; yes.

Mr. HANNA. It is now equally your view that we might continue to utilize the public debt in the sense directly connected with the supply of money. Is that correct?

Mr. JOHNSON. That is not only correct but it is essential in the way a modern central bank operates, that it must operate in public debt.

The existence of the public debt enables it to operate much more flexibly and impartially than if it had to operate in private debt, as was the case in the old days before the public debt got so large.

It penetrates into every segment of the economy, and is much less concentrated in one part of the economy.

Mr. HANNA. I take it that part of your criticism about the operation of the Open Market Committee is related to the whole idea of the separation per se of the Federal Reserve System as the monetary policy decided.

If we made some other mechanism, and I suspect that, Professor Villard, your suggestion is that there ought to be some kind of a mix—I took it from Professor Johnson that you felt that there ought to be a strong relationship to the Executive.

Mr. JOHNSON. Yes, sir.

Mr. HANNA. Would you agree with that?

Mr. VILLARD. I agree completely. As I tried to state, I think the only person to whom power can appropriately be delegated is no one less than the President.

Mr. HANNA. To the degree that we make changes, it would be making a separate agency directly related to the President or the mix, suggested by yourself, of using the agencies now involved but having

them coordinated and responsible directly to the Executive. Is that correct?

Mr. VILLARD. Correct; yes, sir.

Mr. HANNA. All right. Now, on looking at some of the problems that we have in terms of today's operation, the way we are doing it now, it seems to me that you gentlemen were saying that, in a sense, we are trying to solve our problems of bringing together some warring and, sometimes, let's say, incompatible changes by a kind of jousting, it appears to me.

In other words, Mr. Martin is on one horse—and you can call his white or black, depending on how you want to run the television show—and he seems to be jousting against inflation and for a balance of payments and trying to keep the international monetary situation where we will have a certain position with the dollar.

The Council of Economic Advisers, with their orientation, seem to go for growth and employment and, incidentally, try to get price stability and make a bow toward the balance of payments.

Is it your feeling that out of this jousting we really are not getting as good an answer to these things as we might get if we went at it in some other way?

Mr. JOHNSON. That is certainly my opinion. In effect, we are in the position of attempting to drive a car by putting one person in charge of the steering, another in charge of the rate of engine turnover, and another in charge of the brakes and saying, "Now, fellow, that is your responsibility; you look after the brakes."

Well, naturally, he is going to concentrate on the brakes, and he is going to be disturbed from time to time by changes in engine speed or changes in the steering.

And, in effect, we have a problem facing us of combining full employment, growth, and the balance of payments; we have different people in charge of different pieces of this, and it is wider than just the monetary policy.

For example, the Labor Department has a concern with unemployment. It tends to think of it in terms of the solving of labor problems: more time in school, better training, shorter workweeks, and so forth.

So that we have all these people looking at what is essentially an indivisible problem from a particular point of view, and working at their own policies on it in terms of what they control and what their responsibilities lead them to think are important.

Monetary authority concerns itself with price stability, stopping inflation, and balancing the balance of payments. The Executive, as far as it can, is trying to pursue all of these problems, but it is working with different agencies which are not well coordinated and which take different views of things.

In my judgment, the problems have to be looked at as a related set of problems, and you have to balance these different tools and you have to balance the specific concerns of the particular agencies with their own problems.

Mr. VILLARD. I am in complete agreement. I think it is a question of what I referred to as the tradeoff between objectives which are desirable but contradictory.

One has to decide how much employment one wants to create, given the fact that a very high level of employment undoubtedly puts

greater pressure on prices and causes increases in our balance-of-payments difficulties.

It seems to me that what is urgently needed is an agency where these tradeoffs can be worked out, where the President can decide what the tradeoff is to be in terms of his grand economic strategy. I might add that I think some of the problems that the monetary authority is being asked to do something about are well beyond their competence. I do not mean beyond their technical competence but rather beyond their powers.

I have in mind specifically that, in my judgment, the balance of payments is probably going to be a serious restraint on the level of activity of the country so long as we do not change the arrangements that we have in the direction of providing greater international liquidity, on the one hand, and also, in my judgment, to permit some variation in exchange rates.

Well, that is well beyond the power of the Federal Reserve, and to ask them to cope with the matter, given present arrangements, is going to inevitably ask them to undertake a level of restraint which may not be desirable in terms of other objectives.

Mr. HANNA. I think, from what you gentlemen said, it kind of bears out the basic feeling that I have had; that, in this area, as in many others, there is a basic dependence on what happens. If you do one thing something else happens.

It has also been my view that the relationships are much more important today than the independent units and that, therefore, the thing that has not been encompassed is who is responsible for the relationships. People have been responsible for the components but nobody is responsible for the relationships.

Now, I noticed that, when our industrial complex was faced with this kind of a problem, in the development of the missiles, they developed what they called the "systems analysis" type of approach, in which somebody was responsible for the relationships of the various units and had their eye on the coordination or inner actions. Is it your suggestion that, whereas you really think we ought to be moving in terms of—

Mr. VILLARD. I would even be broader than that and say it seems to me that the analogy should be with the security problem, where a great many agencies of Government were involved with what added up to our national security, and out of that need came the National Security Council. I offered that as a valid analogy. It seems to me that we need an economic council which would coordinate our policies.

There is no doubt in my mind that the rate of increase in wages is a factor which influences the rate of increase in prices which, in turn, influences the degree of overall employment that it is possible to achieve without upsetting the tradeoff ratio between price increases and employment that the Federal Reserve can be expected to accept.

Now, therefore, it seems to me that one has to look at the problem as a whole because, perhaps, the key thing in achieving more employment, which I am sure we are all for, is to devise techniques to prevent this being accompanied by rapid increases in prices and balance-of-payments difficulties—and this is something which needs a very broadly coordinated approach rather than something which is handled piecemeal where it cannot be handled effectively.

Mr. HANNA. Mr. Johnson, you would then say, in terms of what Mr. Villard says, that you agree with him and that coordination is not possible so long as the Fed's or the Federal Reserve is the one place where we have a very important unit which does not have any responsibility now to the President and, therefore, could not be coordinated by the person who reasonably has to do the coordinating, and that is the Executive. Is that correct?

Mr. JOHNSON. That is correct; yes, sir.

Mr. HANNA. Thank you, Mr. Chairman.

The CHAIRMAN. Yes, sir. I would like to ask you gentlemen to comment on this statement: The Open Market Committee has now about \$34 billion in bonds. Suppose we should fix a 4¼-percent rate as the maximum yield for Government obligations, and then suppose bond prices dropped to where someone would have to buy these bonds to keep them at 4¼ percent, as was done, of course, during World War II. And suppose the Federal Reserve should buy those bonds, and suppose the Federal Reserve should increase their holdings from \$34 billion to \$100 billion, or maybe \$150 billion—a half of the national debt.

If proper corrections were made along with these acquisitions, how could that be detrimental to the public interest when, instead of the debt costing \$11 billion a year to service, it would only cost one-half that much? What would be your comment on that, Professor Johnson?

Mr. JOHNSON. Sir, I think you are defining the public interest only in terms of the interest cost to the debt. I think it would be against the public interest if this process involved inflationary development in the economy, which—

The CHAIRMAN. Well, I would agree with you if it involved inflation, but, you see, when you have a car that can go 100 miles an hour, that does not mean that you will not put on the brake, and the same way here.

As you began to acquire these bonds, and if there was danger of inflation, you could increase the reserve requirements of banks, which is a most effective method, I believe. Would you not think that would offset the possible inflationary effect of the acquisition of the bonds?

Mr. JOHNSON. I would agree that it is an effective method, but I have already argued this morning that the consequences of it would be, in effect, to place a tax on the banks and, therefore, on the customers.

The CHAIRMAN. Place a tax on banks?

Mr. JOHNSON. In effect, yes. You would be forcing them to hold no interest-paying deposits—

The CHAIRMAN. No, that is just the Federal Reserve banks.

Mr. JOHNSON. The member banks, yes.

The CHAIRMAN. No, the Federal Reserve banks.

In other words, I am saying that if the Open Market Committee acquired up to half of the national debt, of course, the reserves would be increased in the banks, and it could cause inflation, but you can offset that by increasing the reserve requirements of the banks.

Mr. JOHNSON. That is exactly the point I am making, sir.

If you increase the reserve requirements, you are, in effect, forcing the banks to hold a higher proportion of their assets in the form of non-interest-paying deposits.

Therefore, indirectly what you are doing is taxing the banks in the sense that you are reducing their profits by making them hold these deposits which, in turn, indirectly are Federal Reserve holdings of public debt.

So that the essence of the matter is that the banks are being forced to hold noninterest bearing assets which match the absorption of public debt by the Reserve banks.

Now, one might well believe that banking in the country should not be conducted as it is, mainly that banks should be simply cloakrooms which hold money and charge their customers the full cost of any banking services they get.

At present the customers get services which they do not pay for because the bank makes money on its loans, and these earnings, in part, go to finance services provided to the customers.

Now, that would involve a change in the whole nature of banking which we could argue, but if we do not want to contemplate that kind of a fundamental change in the nature of banking in this country then we have to realize that the effect of this policy would be to tax banks.

To force them either to contract their activities or to pass more of the cost on to the depositors, would be the results, and there are issues of public policy involved in this that would have to be debated.

The CHAIRMAN. I believe your argument is very similar to one that Mr. Eccles made, and you are familiar with his argument on that, that, in other words, we have got to have the banks' services some way and they have got to have profits.

And, of course, I agree that they must be profitable institutions and if they are not allowed to profit this way we would have to subsidize them because we have got to have them, and he used the word "subsidize" one time.

Mr. JOHNSON. Well, I am not prepared to argue that we should subsidize the services—

The CHAIRMAN. No, he was not either, but he said we had to provide the service and if we did not allow them to make it this way that they would have to be subsidized or taken care of in some way. What is your comment on that, Professor Villard?

Mr. VILLARD. Well, I think it is exactly along the lines of what Professor Johnson has said.

It is perfectly true that you can offset the inflationary effects of increased purchases of Government bonds by raising the reserve requirements but to do so reduces bank holding of such assets.

Now, it is conceivable, to run a banking system, for example, in which the banks have no earning assets whatsoever—in other words, the so-called 100-percent reserve approach. But then the banks, in order to be able to provide the services which they are now compensated for out of their earnings, in part on Government bonds but to some extent in other forms, if they were not compensated out of their earnings they would have to pass these charges directly to their depositors.

I do not see any net benefit coming out of this that would be significant.

The CHAIRMAN. The hearings have developed the fact that the Federal Reserve System has almost gone out of business, the way I see it, except the Federal Reserve Bank of New York through its open market operations.

The other 11 banks do very, very little business. At one time a major part of their earnings came from the discount window, but the discount window is not used much now.

The number of transactions in each Federal Reserve district is very low over an entire year, probably not enough to justify the employment of more than three people.

So the question naturally arises of what should be done about this. The check clearings represent a large part of the business of these other 11 Reserve banks.

So, should we consider turning the check clearings over to the banks and let them do it at a price which would probably be greatly reduced from the cost to the Federal Reserve System?

Do you think that the banks could service these checks at a much lower cost, Professor Johnson, than it is costing now through the Federal Reserve?

Mr. JOHNSON. I am really in no position to judge what the cost would be through private enterprise as compared with the Federal Reserve System. But I would agree with the general tenor of your question, which, as I see it, is this, that we now provide a system through which the public gets free clearance of checks between the different parts of the country, the cost of which is borne by the members of the Federal Reserve System through the Federal Reserve check clearing operations.

And it seems to me that the check clearing is not a necessary part at all of a central bank's business. In other countries, they do not provide these services, at least not to the same extent, and there is much to be said for allowing competition to operate in what is essentially a private service.

In other words, it seems to me that the desirability of having free clearance of checks between remote parts of the country is very moot. In some ways it promotes economic inefficiency because if you can transfer money without cost over great distances this tends to disperse the economy and offset other advantages of concentration of economic activity.

So I think I would be in favor of transferring the check clearing functions and letting the banks set up whatever arrangements would be efficient.

The CHAIRMAN. Even though the Government pays the cost, as it does now, it would probably be out more money?

Mr. JOHNSON. That might well be true.

The CHAIRMAN. Before I ask Dr. Villard to comment on this, would you please extend your remarks in the record on what other central banks do concerning clearing checks and rendering services which, of course, you said is something that we are doing for the banks?

Mr. JOHNSON. Well, the banking systems that I am most familiar with are those of the United Kingdom and Canada, and there is the point that their banking systems are heavily concentrated so that you have branch banks, very many branches, and they do their own internal clearing through the branches.

They also have a clearinghouse which does the clearing between the banks.

So that what their central bank mostly does is to transfer deposits on its books between these banks, but most of the check clearing goes

on outside and is organized by the bankers through their clearing-houses.

The CHAIRMAN. Professor Villard, would you comment on this:

Do you consider check clearing a private matter that should be conducted by the private banks themselves or is it a public function that the Government should do through the Federal Reserve and pay for at the taxpayers' expense?

Mr. VILLARD. Well, I would like to pick up the point that Professor Johnson was just making, that there are quite significant differences between a large number of small banks and the banking systems of Great Britain and Canada.

It seems, therefore, that we have got to have some system of overall clearing, and I must admit that I am not clear that private enterprise could clear significantly less expensively.

Certainly, I would not like to see us return to a situation in which, when accepting a check we had to worry about whether the bank was going to honor the check—the sort of thing that occurred in the 19th century—

Mr. HANNA. Mr. Chairman, will you yield right here, because I would like to get this point across to the gentleman.

Is it not true that the check clearing is directly related to the velocity of money in the society, and is it not in our best interest to keep that velocity as high as we can so that no matter what we do we certainly need a very efficient kind of check clearing if we are going to get more velocity?

It seems to me that there are two things that function here: one, the amount of money you have got and how fast it will operate because you can do more with less money if you have velocity. Is that a germane point, sir?

Mr. JOHNSON. I think it is germane in the sense that the argument for returning this function to private enterprise, is that it might well be carried on cheaper and therefore would facilitate more efficient use of money. It is certainly germane to the issues.

Mr. VILLARD. But there may be times when you do not want high velocity, if such velocity creates inflation.

It is very hard to know whether it is desirable to increase velocity until you know what the conditions are. But let me make clear that I am all for the efficient clearing of checks.

I am just not at all clear in my mind about how it can best be done. I have not thought about the matter very much, but I am not at all clear that it can be done better by private enterprise than it can in a system in which each member bank has to hold deposits in one of the 12 Reserve banks. This seems to me in many ways to be an arrangement which facilitates the whole clearing operation.

Now, maybe private enterprise could come up with better alternatives, but it is not immediately obvious to me that this is the case.

Mr. JOHNSON. Well, if I might make a historical comment, the emergence of bankers' clearinghouses and the very origin of them was out of a realization by banks that they did not have to keep trading deposits back and forth with each other but could add them up and cancel them out against each other.

It seems to me, in the argument that you presented against returning the clearance of checks to private enterprise, you are mixing up



very different things because you mentioned the question of whether the check would be honored and so forth.

Now, it seems to me that this is a question of the integrity of the bank, which is handled in other ways. I do not really see that the clearing process does anything about that.

It also seems to me that if the banks were left to themselves they would very quickly come to police each other and make sure that they perform properly. The performance of this function by Government doesn't seem to me to have any particular justification.

It may well use more resources than would be required if it were run on business lines, and it does not seem to be any part of a central bank's function. That function is to control the total reserves available to the banks.

The clearing function does not have anything to do with that. It is simply a question of clearing all transfers between banks down to a net figure, and it is a bookkeeping operation which, I think, could be handled quite efficiently without the Federal Reserve being responsible for it.

The CHAIRMAN. The Federal Reserve banks earn about 1 percent of their cost. How can you justify continuing an organization of 20,000 people, like it is now, with not only presidents being paid from \$70,000 and \$40,000 or in that range, but vice presidents galore, and every one of them being paid somewhere among those figures?

How can you justify continuing that type of service with such a large overhead and with so little in the form of meaningful results? Would you comment on that, Professor Johnson?

Mr. JOHNSON. Sir, I do not regard myself as being here to pass judgment on the justification or otherwise of this kind of thing.

The CHAIRMAN. That is all right. If you do not want to answer it, it is perfectly all right.

Mr. JOHNSON. But I would remark that I think the initial plan for the 12 Reserve banks was a compromise which belonged to a much earlier stage of the country's history, and that there is now really no scope for 12 central banks because, in effect, the market is so well integrated that 1 operating bank is enough.

If the others have developed these other functions, in a sense I would think the purpose was to justify their existence, and I certainly think the question of whether it is worthwhile having this widespread organization with duplication of departments in different parts of the country is justified—I feel, as I say, in my statement, that the Federal Reserve does staff itself rather lavishly for the task that it actually performs and the question as to whether this is justified is well worth raising.

The CHAIRMAN. What are your comments, Professor Villard?

Mr. VILLARD. I must admit that I am less clear that the level of staffing is undesirable. It is certainly something on which I do not feel I am an authority, but I would raise the question, going back to the matter of check clearing, as to whether a privately operated system would be significantly less costly.

If it could be demonstrated that this was the case, and there were real economies to be realized, then I would obviously be inclined to go to a private system, but it is certainly not something on which I am immediately clear and, therefore, I would not want to suggest that it is certain that if we took this function away, or broke it out—

and I agree that it could be broken out, as it is certainly not an essential part of central banking—but I do not know, if it were broken out, that it would save us a great deal.

It seems to me that this is a subject for careful investigation.

The CHAIRMAN. I will read a couple of questions here, and I will shorten my questioning.

The regional Federal Reserve banks spend money on such things as adult community education, advice on manpower retraining, research on mass transit problems, research on regional economic development, and so forth.

Is it possible that the Federal Reserve, its entire building and so on, is duplicating the spending and efforts of other Government agencies?

More important, is it possible that some spending by the Reserve banks gets the Government into activities and areas where Congress has not yet authorized the Government to go and which, when and if Congress decides to appropriate money for these activities, would not necessarily be assigned to the Federal Reserve?

What do you think about that, Professor Johnson?

Mr. JOHNSON. I agree, sir. I think the Federal Reserve banks in various parts of the country do do a lot of things for which there is no obvious reason that they should be responsible.

I feel this is in part the result of an urge on the part of the Federal Reserve System to build itself a political base by performing useful services for its clients in order to encourage a favorable attitude.

Once you set up an institution of this kind and give it funds on a large scale it will attempt to do something which will justify the existence of the institution and so it will get into these things.

The CHAIRMAN. It is perfectly natural that they will; yes. May I suggest, Professor Johnson, that I agree with you, that it is natural that they will reach out and try to justify their existence and they do that largely by insisting and contending that they are carrying out the Full Employment Act.

You know, up until the Full Employment Act passed they did not have too much to hold to about getting out into certain activities that they are now engaged in, but in the Employment Act I think their activities are supposed to be restricted in cooperation and in coordination with other Government agencies. Is that not your understanding?

Mr. JOHNSON. Yes.

The CHAIRMAN. So, they are going out on their own, doing something alone under the Full Employment Act that the Full Employment Act says that they shall do only in coordination with other Government agencies. Is that not your understanding?

Mr. JOHNSON. I had rather let Professor Villard answer that.

The CHAIRMAN. What about that, Professor Villard?

Mr. VILLARD. It seems to me that some of the things may well be desirable. While some people may well want to transfer them from the Federal Reserve System to some other Government agency, I would want to be certain that this would be desirable. I am not, for the minute, commenting on your point that the Congress may not have authorized some of the activities. But the Federal Reserve has a long record of giving us a great deal of useful economic information.

I do not know whether that was something they should have done or not, but I know it is something that I am awfully glad they did.

Now, maybe some other agency should pick up and carry on the index of production, but in the absence of some other agency providing us with this type of information, I would think it would be wholly desirable for the Reserve to continue.

The CHAIRMAN. That is done by the Board and not the banks; is it not?

Mr. VILLARD. That is correct. I was not for the minute distinguishing between the Board and the banks.

I, in general, do not feel too well qualified, as I have not analyzed the operations of the individual banks to see whether they include things which are either not particularly necessary or duplicate what others do. But I will admit that my general impression is that they do not, but it is a question which I do not have a strong basis for answering.

The CHAIRMAN. When minimum bank earnings, after taxes, are about 10 percent of the average bank capital account, this being so, does not the requirement that a member bank of the Federal Reserve must subscribe capital, which pays only 6 percent before taxes, deter banks from joining the Federal Reserve System? What do you say about that, Professor Johnson?

Mr. JOHNSON. Well, in my paper, sir, I made that very point, and it is for that reason that I support the bill, to end this provision.

One might argue that the bank makes much less than 6 percent on other assets; but this particular element of their assets is a part of their equity and the yield on it should be compared with their equity in general and not with the lowest yielding assets which they have.

The CHAIRMAN. Is that your view, Professor Villard?

Mr. VILLARD. Well, I was basing my reaction to this in large part on Mr. Martin's testimony in which he implied that the banks did find that the return on the stock they owned was attractive.

If this is not the case, and the banks would prefer not to own the stock, then I would modify my opinion.

Actually, I do not think that the particular issue of stock ownership can be divorced from the broader problem of the way in which we organize our banking system; I certainly would not like to see anything move us in the direction of making the appeal of State banks greater.

The CHAIRMAN. Would it be all right with you gentlemen if any members of our subcommittee should want to ask you a question, for them to submit it in writing, then you can answer it when you have the transcript?

Mr. JOHNSON. Yes.

Mr. VILLARD. Yes, sir.

The CHAIRMAN. Mr. Brock wanted to ask you some more questions; did you not?

Mr. BROCK. Yes, sir. Professor Villard, I am interested in your statement in which you recommend not the adoption of the bills that are under consideration but a somewhat different approach in which we create, in effect, an overall coordinating policy committee subject to the President.

Now, I noted in your statement here on page 6, that you say this— if under such delegation the President were to abuse his powers, say,

to obtain low interest rates for the Treasury the electorate would then know whom to hold accountable for any subsequent inflation.

This is an interesting theory; but it is not true that, for example, if a President were running for his second term he could create certain policies which, over the short range, would not prove detrimental to the economy, at least in his immediate applications or its immediate applications, but which would be detrimental, say, in 3 or 4 years or even 1 or 2 years, but immediately after an election?

Is it not true that you would create more political pressures for changes in monetary policy overall, economic policy, with the change in the administration, with the advent of some new pressure on the President?

Are you not subjecting yourself to some rather drastic shift according to the winds if you take this position?

Mr. VILLARD. Well, I do not believe so, because it seems to me that—perhaps I should answer it the other way around and say that obviously the President will be subject to political pressures, but what I am concerned with is that he should be the one who makes the basic economic decisions.

Now, in making these decisions he will undoubtedly be subjected to pressures, pressures on the one hand, for example, to reduce the level of unemployment, pressures on the other hand, to prevent an increase in prices.

I think both of these alternatives generate political pressures. I sometimes worry about the fact that the pressure on the President to prevent an increase in prices may be more powerful politically because everybody is subjected to price increases but there are only a relatively small percentage of the population who are unemployed, so that it may well be that he will give too much weight from my point of view to preventing price increases.

But I do not see, in a democracy, any alternative except to give the power to make decisions on basic economic policy to the Executive. This does not guarantee that he will make the right decisions all the time, but I do not think there is any possibility of setting up a group of experts who should have this power.

In fact, I agree with Professor Johnson's point that you would really have to have a fourth arm of the Government composed of experts if you do not want to give the power of the President.

In short, it seems to me that, to the extent that power can be appropriately delegated by the Congress, it must be given to the President.

The CHAIRMAN. Mr. Brock, will you yield for just one other observation, please?

I would like to ask you to consider that in a democracy, as the witness just brought out, elected officials are held accountable.

Now, in your facts as you stated in your hypothetical case, it is true that the Executive would have lots of power and he could create certain conditions, but he has something to lose. He is an elected official.

If he does not do the right thing, the people have a recourse. They can defeat him. They can defeat his party for years to come. There is a great penalty, but if you put it off and let the bankers run it and people who cannot be reached by the electorate, why, they have nothing to lose.

You have no way of getting back at them. I hope you have considered that, Mr. Brock.

Mr. BROCK. I have considered it, Mr. Chairman, and I have also considered that a President, in his second term, is subject to the whims of nobody, because he cannot be reelected and, therefore, is in a position to make decisions which perhaps are not in the best interest of the American people or even preferred by the American people.

The CHAIRMAN. But he would have his own party involved, whether it be Republican or Democrat, and he would have their future at stake.

Mr. BROCK. That is possible, but it perhaps is not the overriding consideration.

Mr. JOHNSON. May I make an observation?

The whole democratic political system rests on the assumption that the political leaders will be responsible to a bigger conception than their own interest, and the two-term limitation has been with us only for a limited time, but I do not think the evidence is that it has made Presidents sacrifice the interest of their country to their own, just because they will not be elected.

It is a continuing thing even though the individual is going to be eligible for reelection or not eligible.

He will still have others around him who will be seeking reelection, and he will have to retain their loyalty by pursuing the interest of the party as a whole.

If we were to act on the assumption that as soon as you elect a man, and he gets into a position where he knows his political future will be limited, he will immediately start to pursue his own interest to the neglect of the longer run continuity, I think you are finished, because everybody is mortal.

Each individual sooner or later comes to the point where his remaining life is going to be short enough where he can do incalculable damage to the country without paying any penalty.

But this will not happen if people who get to be leaders recognize their obligations.

Mr. BROCK. I think we are getting into a broad philosophical area, and I will get away from it as quickly as we can resolve it, which may be 10 or 20 years, but this country was not set up to give weight to your idea that we have to depend on the best possible people in office.

It was set up on a principle of checks and balances, believing that all men are human, and we set up this check-and-balance system in order to insure ourselves against such an abuse.

Now, you are completely falling away from that theory when you say we do not need any controls upon an elected official. Now, my point is that when you have an economic system you need a stable monetary supply.

The purpose of the Federal is not a political purpose. It is a purpose which is designed to insure constitutionality within the same context—the Congress and the Executive, of balance in their responsibilities. I do not think we need to pursue the point.

Mr. VILLARD. Would it be useful for me to comment on the direct points that you are raising?

Mr. BROCK. Surely; go ahead.

Mr. VILLARD. You are thinking that monetary policy or a stable money supply or whatever is something that can be decided in isolation.

I think there was a time when this made a considerable amount of sense, but I think what has happened is that there is today no real role for monetary policy except as a part of overall economic policy.

The real question is whether it is better to give ultimate responsibility for monetary policy to a separate organization or to devise some way of coordinating overall monetary policy with overall economic policy.

Mr. BROCK. I do not think, in the sense of what you are saying, that we are actually arguing.

Perhaps we are oversimplifying each other, because I would not at all advocate that the Federal Reserve be an island unto itself.

It certainly has to operate within the context of an overall economic policy, and I do not object to any effort to increase the coordination. What I object to is the placing of our monetary system under direct absolute control of the Secretary of the Treasury or the President, either one, when he has authority, as he does under this bill, to fire any member at any time just at his whim.

Mr. VILLARD. Well, as I indicated, I have a high regard for the members of the Federal Reserve System, and they are doing what they think is right. So, therefore, I would prefer to see us work through cooperation rather than compulsion.

But I must admit that, if it were to be an irreconcilable conflict, if the Federal Reserve were to come to the conclusion that certain policies had to be followed which were felt by the President to impede the pursuit of what the country needed in the way of an overall economic policy, then I must admit that I believe that some way should be found to enable the President to achieve his objectives.

Mr. BROCK. I do not think we have reached that situation, though.

Mr. VILLARD. But I must admit that I do not think we are so terribly far from it—in the sense that there could be disagreements of a sort which could lead to serious problems unless, in fact, it is understood that the Reserve System is not to pursue goals which are in conflict with those of the Chief Executive.

Mr. BROCK. Let me take this into a specific context, if I may. Mr. Johnson, you mentioned, in commenting on Mr. Patman's statement, that the Fed does have to justify its existence. That it, perhaps, would tend to become a political entity.

Would you compare for me the justification that the Federal Reserve has to make for its existence with the justification that the Postmaster General has to make for his existence as an appointed official by the President?

Mr. JOHNSON. Well, I suspect there is more to that question than I quite grasped.

The CHAIRMAN. Pardon me, Mr. Brock, but we have a bill up on the floor at 12 o'clock and we are first up. We will have to go soon. Would you ask him to answer this in writing for the record?

Mr. BROCK. All right. The question was, if I can repeat it—some of the members have been comparing the Federal Reserve with the Post Office Department. I do not think there is any comparison possible, but my point is that the Post Office or any appointive head of an agency is certainly more prone to try to spend his time justifying his existence because he can be fired immediately if he does not. He has to be political.

Certainly an agency head, appointed at a whim, could be fired by the Executive and he would be more subject to an attempt to try to reconcile his political entity, to try to justify his existence, than a political entity such as the Federal Reserve.

Mr. JOHNSON. I think it justifies itself in a different way, because it tries to devote a great deal of effort in trying to persuade the public that it follows the policies that they have approved and—

(The written answer by Prof. Harry G. Johnson to question by Representative Brock is as follows:)

As I understand the record of the hearings, Representative Brock has asked me to compare the justification for its existence that (in my view) the Federal Reserve must make, with the justification for his existence that must be made by an appointive official such as the Postmaster General. Strictly speaking, the comparison should run between the Chairman of the Board of Governors and the Postmaster General. The members of the Board are appointed for a term of years longer than that of the President, and the Chairman for a 4-year period not coterminous with the Presidency. The Chairman cannot be removed at the will of the Executive, whereas the Postmaster General is appointed by and holds office at the will of the Executive; the Chairman is therefore politically independent of the administration whereas the Postmaster General is a political appointee.

The arrangements just outlined make the Federal Reserve System an "independent" monetary authority. The point I sought to emphasize in my statement is that, even though the System is not subject to political control by the Executive, it is nevertheless responsible to public opinion, since its representatives can be summoned to testify before Congress and can be subjected to questioning of its policies, and the Federal Reserve Act can be amended by Congress if the performance of the System causes sufficient dissatisfaction. The Federal Reserve System and its Chairman are therefore obliged to justify their existence in a different and more indirect way than is the Postmaster General. On the one hand, the System seeks continually to justify its existence to the general public through the performance of research and other services aimed at satisfying regional needs, and through explanation of its policies in terms of economic objectives generally regarded as desirable, such as price stability, employment, and the like. On the other hand, it is frequently found defending itself from criticism by stressing those effects of its policies that cast it in the most favorable light—at one time the rate of increase of the money supply, at another the level and trend of interest rates, at still another the volume of "free" reserves—or by arguing that monetary policy has done all that can be reasonably expected of it and that it is the responsibility of some other instrument of policy—debt management, or fiscal policy—to produce further improvement of the economy's performance. As I argued in my statement, the need of the System to justify itself in these ways helps to obscure the real choices between policy objectives that have to be resolved in some fashion or other.

The CHAIRMAN. We will have to conclude because we have gotten word that we are first up and we will just have to go.

Thank you, gentlemen, for everything that you have said. It has certainly been very helpful to us. Thank you.

We will stand in recess until 10 o'clock in the morning.

(Whereupon, at 11:50 a.m., the committee was recessed, to reconvene at 10 a.m., Wednesday, February 26, 1964.)

# THE FEDERAL RESERVE SYSTEM AFTER 50 YEARS

WEDNESDAY, FEBRUARY 26, 1964

HOUSE OF REPRESENTATIVES,  
SUBCOMMITTEE ON DOMESTIC FINANCE OF THE  
COMMITTEE ON BANKING AND CURRENCY,  
*Washington, D.C.*

The subcommittee met, pursuant to recess, at 10 a.m., in room 1301, Longworth House Office Building, Hon. Wright Patman (chairman) presiding.

Present: Representatives Patman, Reuss, Pepper, Minish, Hanna, Harvey, and Brock.

The CHAIRMAN. The committee will please come to order. Today we are going to hear from two more outstanding economists: Professors Karl Brunner, of the University of California at Los Angeles, and O. H. Brownlee, of the University of Minnesota.

Professor Brunner's prepared statement, which will be put into the record in full, is based on a study he made as a member of this committee's staff on the Federal Reserve's operating procedures and policy criteria and the effectiveness of its policies. His findings and conclusions are, of course, his own. He was not guided by any one of us, and none of us are bound to accept his conclusions. But I am sure we can learn much from Professor Brunner. I am also sure that we will learn a great deal from Professor Brownlee.

Gentlemen, we are glad to have you. You may proceed in your own way. It is my suggestion you put your statements in the record at this point. Then if you want to summarize them—because the more time you give us to interrogate you, the better opportunity we will have to bring out the main points we are interested in.

Before starting, I would like to say that a statement of the salaries of other Government officials in the United States compared with the Federal Reserve salaries will be ready tomorrow, and I will put it in at that time. It is rather an amazing statement. It shows the Members of Congress rather low on the totem pole. But the full statement will be put in tomorrow. All right, Professor Brunner, you may proceed.

## STATEMENT OF PROF. KARL BRUNNER, UNIVERSITY OF CALIFORNIA AT LOS ANGELES

Mr. BRUNNER. Thank you very much, Mr. Chairman, gentlemen of the committee. I shall summarize my written statement in order to emphasize the major points.

My written statement covers some fundamental aspects of our policy arrangements in the monetary field. It deals, therefore, only



indirectly with the specific bills before this committee. But I shall be very happy to answer any questions which bear directly on these bills.

It should be acknowledged at this point that my statement is based on research performed together with Prof. Allan Meltzer. In particular, it is founded on a study which we prepared for this committee. A chapter of this study has already been published and other chapters are currently submitted to this committee.

Rational monetary policy involves several ingredients. The first ingredient covers the effective control of the money supply by the Federal Reserve authorities. The second ingredient subsumes the existences of a systematic relation between the money supply on the one side and the behavior of economic activity and the price level on the other.

Moreover, if we grant discretionary power to the Federal Reserve authorities, a power actually provided by the Federal Reserve Act, a third ingredient must be recognized; namely, the rapid and correct recognition by the monetary authorities of evolving economic situations.

It should be acknowledged quite immediately that the Federal Reserve performed most laudably on this point over the postwar period. It spotted turning points quickly and effectively. I would submit that improvements on this performance are quite difficult to achieve.

Of course, such improvements are not impossible. But I would contend that an allocation of resources designed to improve the performance on this score would yield very small returns indeed when compared with the returns to be expected from an allocation of resources designed to improve the Federal Reserve's performance on the first ingredient mentioned before. What I mean is the following:

Our investigations indicate that the control exercised by the Federal Reserve authorities is quite ineffective and could be substantially improved by a suitable exploitation of the resources already available to the Board. An effective control over the money supply involves two elements: First, we note the existence of a systematic effect of policy actions on the money supply; and secondly, that the Federal Reserve authorities recognize the nature of the process on which they operate.

As a result of our studies we came to the conclusion that the Federal Reserve authorities lack a coherently formulated, carefully assessed and validated conception of this process. The monetary authorities are consequently often led into erroneous assessments of evolving monetary situations. Moreover, they are frequently misinterpreting their own policy behavior.

In order to substantiate this point a number of cases were assembled in my written statement. I shall select one single case for my oral summary:

Two charts were constructed for this purpose. Both charts have been appended to the written statement which was submitted to the committee.

Chart 1 indicates the percentage changes of the money supply between corresponding months in adjacent years. The second chart depicts the growth rate of a magnitude of fundamental importance. In order to give this magnitude a name, we have labeled it the "extended base." It is the sum of two components. The first component is the

monetary base. The monetary base is simply the governmental money directly issued by the authorities. It forms the base on which the banking system has erected a superstructure of assets and deposits liabilities. Furthermore, it is completely determined by Federal Reserve credit, gold stock, Treasury currency, and some minor items.

The second component of the extended base is the cumulated sum of reserves liberated from required reserves, or impounded into required reserves, by changes in legal reserve ratios.

Two reasons explain the fundamental significance of the extended base:

First, it is the most important single determinant of the money supply. It is not the only determinant, but it is the most important one.

If you compare the two charts appended to the written statement you will notice the common sweep of the two magnitudes which clearly reflect their close association. Detailed statistical investigations summarized in our report submitted to the committee confirm this close association and also confirm the dependence of the money supply on the extended base.

Secondly, the monetary authorities completely control this magnitude. It is effectively manipulated by the monetary authorities and effectively summarizes actual policy behavior. It is a useful indicator revealing the actual policy behavior of the Federal Reserve authorities.

Having introduced to you the extended base as a policy indicator of crucial significance and described it as a fundamental determinant of the money supply, I wish to draw your attention to one case listed in my written statement, which exemplifies the fallacious policy assessments frequently advanced by the Board.

The Federal Reserve authorities typically assert that they moved to an antirecessionary policy or engaged in a stimulative policy during all the deflationary phases of the postwar period. Let me confront this assertion with the record of actual behavior.

The first recession began in late 1948 and terminated during the second half of 1949.

Chart 1 indicates that the annual growth rate of the extended base collapsed in 1948 to a negative value and remained negative over the whole recession. The Federal Reserve authorities thus engaged throughout the first deflationary phase of the postwar period in an active deflationary policy.

The second postwar recession began in the middle of 1953 and reached bottom 1 year later. During this period the growth rate of the extended base collapsed by more than \$1 billion p.a., from \$1.4 billion to \$200 million. The Federal Reserve authorities thus moved throughout the recession in a deflationary direction. The growth rate of the base remained at least positive and to this extent policy was less deflationary than in the previous recession.

A more pronounced deflationary policy occurs again in the subsequent recessions of 1957-58 and in 1960-61. During a substantial part of the downswing, even after professing a change in policy toward more ease, policy remained actively deflationary. This fact is clearly revealed by the negative growth rates of the extended base observed in 1957 and 1960.

In summary, we find no evidence to support the contention made by the Federal Reserve authorities that they engaged in a stimulative policy during recessions. On the contrary, we find that during deflationary phases they had either a deflationary policy or were moving in a deflationary direction.

Other examples could be adduced from the postwar period, from last year for instance, or from the interwar period, to reveal the strange discrepancies between professed and actual policy.

This discrepancy results from the absence of a clearly formulated and validated conception. In the absence of such a conception, we cannot expect monetary policy to contribute systematically to monetary stabilization.

Thank you.

The CHAIRMAN. Thank you, Dr. Brunner.

(The statement referred to follows:)

STATEMENT OF KARL BRUNNER, UNIVERSITY OF CALIFORNIA AT LOS ANGELES

AN APPRAISAL OF FEDERAL RESERVE POLICY AND SOME PROPOSALS BEARING ON POLICYMAKING PROCEDURES <sup>1</sup>

A number of changes in our monetary arrangements have been submitted to the committee's attention. These and similar proposals deal essentially with a fundamental issue; viz, the efficacy of the institutional arrangements guiding policy decisions and transmitting the resulting impulses to the pace of economic activity. This problem may be usefully divided for our purposes into two distinct aspects. One aspect covers the relation between the money supply and the behavior of economic activity, expressed by national income. The other aspect pertains to the connection between the behavior of the money supply and monetary policy, exercised via open-market operations, changes in legal reserve ratios, modifications of the discount rate, and conceivably adjustments in the administration of the "discount window." Two conditions are thus sufficient and necessary for monetary policy to form an efficacious instrument: (1) The existence of a systematic connection from the money supply to the rate of economic activity, and (2) the exercise of a firm control over the money supply by the Federal Reserve authorities.

Monetary policy would barely deserve much consideration in case economic activity were not affected by the behavior of the money supply or the Federal Reserve had little control over this magnitude. The position of the Federal Reserve authorities on these issues has been strangely inchoate and ambivalent. One wonders whether they recognize existence and nature of the relation between money supply and national income. But I question even more, whether the Federal Reserve authorities possess a clear and validated conception about the nature of the process which determines the money supply. A firm control over this magnitude requires both the existence of a reliable relation connecting it with policy action and the proper recognition of this relation.

<sup>1</sup>The analysis supporting the following statement has been conducted jointly by the author and Allan H. Meltzer at Carnegie Institute of Technology in a series of papers and in a report for this committee, entitled: "An Analysis of Federal Reserve Monetary Policy-Making."

## THE RELATION BETWEEN MONEY SUPPLY AND ECONOMIC ACTIVITY

On numerous occasions spokesmen of the System refer vaguely to the Federal Reserve's responsibility to keep "credit flowing" and to adjust the "availability of credit." These formulations are usually quite elliptical and replete with shadowy ambiguities. Whatever their meaning may be, however, they suggest a conception which denies the relevant operation of the money supply on prices and economic activity. These suggestions are reinforced by an explicit assertion recently made by a member of the Board, who denounced "the assumption" of a "close coordination between growth in the money supply and growth in gross national product" to be "erroneous."<sup>2</sup>

If this assertion were correct, monetary policy would be an exercise of small significance and monetary arrangements barely worth our detailed attention. On the other hand, if the money supply does contribute to shape the behavior of prices and activity levels, then the nature of effective monetary institutions rationally designed to stabilize the economy deserves a careful investigation. Most particularly, the Federal Reserve's overt attitude bearing on this issue would appear to require serious reconsideration. What do we, therefore, know about the relation between money supply, prices, and output?

There is no room in this statement beyond a suggestive and selective outline of the wealth of evidence attesting to the influence of monetary forces. We note, for instance, that substantial increases in the money supply are typically associated with every major inflation ever observed. Whenever we recognize a large rise in prices, we also note a concomitant increase in the money supply. And so long as prices move rapidly, the money stock also expands. The converse applies with equal regularity. Whenever the money stock increases at a sufficient rate, prices rise and continue to rise unless the money stock is stabilized. The hyperinflations observed yield excellent evidence in support of this contention, and so do the more or less intermittent inflations of numerous Latin American countries.<sup>3</sup>

The behavior of prices and money stock in the Confederacy during the Civil War offers a particularly incisive piece of evidence. The Confederate governments had financed the war to an even greater extent than the Union by issues of new paper notes. In the earlier part of 1864 a determined attempt was made to change the financial arrangements and to hold the money stock in line. Within a very short interval the inflationary momentum was broken and prices even declined. But a few months later, political and administrative convenience overcame financial prudence. The money stock resumed an accelerated growth with a consequent rise in prices.<sup>4</sup> One may also note that receding activity levels typically occurred after the growth rate of the money stock fell below a barrier of 3 percent per annum. Chart I appended to this statement exhibits the relevant observations

<sup>2</sup> 49th Annual Report of the Board of Governors of the Federal Reserve System, 1962. The assertion occurs on p. 71 under the "Record of Policy Action." The assertion was made at the session of the FOMC, Mar. 27, 1962.

<sup>3</sup> The reader may usefully consult the excellent study by Philipp Cagan on "The Monetary Dynamics of Hyperinflation," in: "Studies in the Quantity Theory of Money," Chicago, 1956, edited by Milton Friedman.

<sup>4</sup> The events have been excellently described by Eugene M. Lerner, "Inflation in the Confederacy, 1861-1865"; *op. cit.*

for the postwar period. Other studies have investigated this pattern over many decades.<sup>5</sup>

Some revealing contours emerge from a comparison of several post-war cycles with respect to the behavior of money stock and unemployment rates. The half-cycle beginning with the trough of 1949 and terminated with the peak of 1953 was accompanied by a growth rate of the money stock which persisted for a lengthy period at a high level. The unemployment rate dropped very rapidly from 7.6 percent in February 1950 to a range between 3 and 4 percent at the end of the year. The average rate of decline slowed subsequently, but the decline continued to a low of 1.3 percent in October 1953. The momentum of the persistently high growth rate exhibited by the money stock in 1950, 1951, and 1952 contributed to absorb the available labor resources into current activity. The half-cycle beginning with the trough of 1954 and ending with the peak of 1957 shows a radically different pattern. The growth rate of the money stock expanded to a high rate reached in June 1955, then it faltered, decelerated gradually toward the end of the year and abruptly collapsed at the beginning of 1956. It oscillated during the remaining phase of the upswing around a low level of 1 percent per annum. This pattern is strongly reflected in the behavior of the unemployment rate. This rate moved again sharply downward with the onsetting recovery from around 5½ percent to a range of 3½ or 4 percent in the last quarter of 1955. From this point on, however, contrary to the previous upswing, and in accordance with the behavior of the growth rate of the money stock the decline in the rate of unemployment is suddenly stalled. There followed a period of oscillations around a slightly rising trend of unemployment, eventually aggravated by the downswing of 1957-58.

The half-cycle beginning with the trough of 1958 and terminated with the peak of 1960 supplies further information for our purposes. The growth rate of the money stock increased rapidly from the onset of the recovery to a high level of 4.8 percent per annum in January 1959. It decelerated slowly until June to 4 percent, whereupon it collapsed to a negative growth rate in February 1960. The rate of unemployment, on the other hand, began its decline from a high plateau of 7.7 percent and moved steeply to around 5.7 percent in the last quarter of 1958. The downward trend, strongly attenuated, however, continued to the middle of 1959. Around this time, when the growth rate of the money stock fell away to a negative value, the downward trend in the rate of unemployment vanished.

The above discussion indicates the broad association between the behavior of the money supply and the behavior of the unemployment rate. An accelerating growth rate of the money stock has been typically associated with declining levels of unemployment. Gradual retardations in this growth rate were reflected in the appearance of slower and more hesitant absorption of unemployment, expressed by comparatively larger oscillations of the unemployment percentage around an attenuated trend. Moreover, low or abruptly collapsing growth rates tended to be associated with a stationary or even slightly increasing unemployment trend, accompanied by rapid and comparatively substantial short-run fluctuations.

---

<sup>5</sup> The reader is referred to Beryl Sprinkle's "Monetary Growth as a Cycle Predictor," *Journal of Finance*, September 1959.

These patterns also hold for our most recent experience. The growth rate of the money stock reached a provisional peak of 4 percent in December 1961 and gradually dropped in subsequent months to a low of 1 percent in October 1962. The motion was accelerated in November which brought it to a 4-percent level in November 1963. And the percentage of unemployment? Similar to the previous cases we observe a rapid decline until February 1962. The rate of fall then decelerated quickly and in July 1962 the trend was reversed. The unemployment rate oscillated around a slightly rising trend. A week downward trend was thereupon resumed in the early months of 1963, thus reflecting the impact of the accelerated growth rate of the money stock.

Other studies may be adduced in support of the contention that the money stock does exert a substantial effect on the behavior of economic activity and the rate of utilization of our resources.<sup>6</sup> Lest there be a misconception as to the meaning of the relation between money and income, it should be emphasized that the behavior of economic activity and prices is not solely determined by the behavior of the money stock. In the context of our economic organization both monetary and nonmonetary forces jointly operate to shape the behavior of national income. The peculiar interaction of these sets of forces determines the appropriate range for the growth rate of the money supply. Beyond this range inflation becomes likely and below it deflation threatens, revealed by either falling prices or curtailed output. Control over the money supply yields thus no assurance of paradise. In particular, control over the money supply is not sufficient to eliminate all fluctuations in aggregate activity. But intelligent control over the money supply can be sufficient to eliminate destabilizing impulses generated by the monetary system and maintain the remaining fluctuations in a comparatively narrow range.

#### THE FEDERAL RESERVE AND CONTROL OVER THE MONEY SUPPLY

In 1952 the Joint Committee on the Economic Report published a study which contained, according to a spokesman of the System, the best statement made by the Federal Reserve authorities. The Board acknowledged at the time that its "most important functions" are "those affecting the money supply."<sup>7</sup> On the same occasion the Board acknowledged an obligation to convey pertinent knowledge about monetary events to a larger public. The obligation presupposes, of course, that the Board has systematically acquired a validated knowledge about the monetary process. I submit that the Board has not performed this task. The resulting situation seriously impairs the quality of monetary policy.

<sup>6</sup> The reader may consult Allan H. Meltzer's statement presented to the Committee on Feb. 11, 1964, for some additional material. He is also referred to the following papers: Karl Brunner and Anatol Balbach, "An Evaluation of Alternative Monetary Theories," in *Proceedings of the Western Economic Association*, 1960, and Karl Brunner and Allan H. Meltzer, "Predicting Velocity; Implications for Theory and Policy," *Journal of Finance*, May 1963.

<sup>7</sup> "Monetary Policy and the Management of the Debt. Their Role in Achieving Price Stability and High Level Employment." Part I, Washington, D.C., 1952, p. 246. This report is subsequently referred to as the Patman report. A different view has recently been stated by the presidents of the 12 Federal Reserve banks. They asserted that monetary policy is essentially concerned with the "overall availability of credit." Part I of their answer to question I in the questionnaire appended to the study mentioned in the star footnote.

The existence of a systematic and reliable connection between policy actions and the behavior of the money stock is not sufficient for the execution of a useful policy, even with the explicit recognition that money does affect the pace of activity and the price level. Useful policy also requires a validated knowledge about the nature of the money supply process.

The remainder of this section presents a sequence of exemplifying cases to support my contention that the Federal Reserve authorities lack a coherent notion of the process operated on, that they are frequently guided by fallacious assessments of evolving situations, and even misconstrue the meaning of their own policy behavior. The argument is based on a detailed empirical analysis of the U.S. monetary system to be published in some other context.<sup>8</sup> This analysis guided the selection of the two charts appended to this statement. Chart 1 exhibits the percentage change in the money stock (i.e., currency outside banks and demand deposits adjusted) between corresponding months of adjacent years. The change is located at the terminal month. A 4-percent increase noted for November 1963 thus means that the money stock rose from November 1962 to November 1963 by 4 percent. The second chart (denoted by  $\Delta B + \Delta L$ ) presents the growth rate of the extended monetary base. The monetary base consists approximately of the money directly issued by the Federal Reserve banks and the Treasury. Its volume is determined by Federal Reserve credit, the gold stock, Treasury currency issued and a few comparatively minor items in the balance sheet of Federal Reserve banks. The base effectively summarizes the Federal Reserve's posture bearing on open market and discount policy. In order to obtain a magnitude which completely summarizes the total policy actions, the base is extended by adding the cumulated sum of reserves "liberated" from required reserves (or impounded into required reserves) through changes in the requirement ratios.<sup>9</sup> It can be shown that the extended base forms a unique index reflecting the Federal Reserve's actual policy behavior. In particular, the Federal Reserve authorities can modify this magnitude with the aid of discount policy, open market transactions and changes in legal reserve ratios. Furthermore, the behavior of the extended base dominates the behavior of the money supply. Detailed analysis and evidence supporting this contention have been published elsewhere.<sup>10</sup>

Still, the reader may usefully compare the broad contours of the two charts appended. Changes in the extended base between corresponding months of adjacent years are plotted in the second chart. The changes are again located with the terminal month. The reader will immediately notice the close similarity of the broad contours. As a matter of fact, a more detailed inspection reveals to the reader that the similarity goes beyond these broad contours to some detailed features. The gross correlation between monthly data of annual

<sup>8</sup> Work performed jointly with Allan H. Meltzer at the Carnegie Institute of Technology will be published in a monograph on "Money Supply and Money Demand." The reader may also consult ch. VI of our study, "An Analysis of Federal Reserve Monetary Policy-Making." This chapter will be available in a few weeks.

<sup>9</sup> No justification can be developed at this point for the procedure indicated. The reader will find this justification in the material mentioned under the previous footnote. The reader may also consult Karl Brunner, "A Scheme for the Supply Theory of Money," *International Economic Review*, January 1961.

<sup>10</sup> See footnotes 8 and 9 and the forthcoming paper by Karl Brunner and Allan H. Meltzer on "Some Further Investigations of Demand and Supply Functions for Money," *Journal of Finance*, 1964.

changes in the money stock and monthly data of annual changes in the extended base actually measures 0.82. This means that approximately 67 percent of the observed variability in the annual changes of the money supply can be explained by variations in annual changes of the extended base. This magnitude is not the only determinant of the money stock, but it is the single most important one. Moreover, it is effectively manipulated by the Federal Reserve authorities.

At this point, the stage has been set for an inspection of a sample culled from a large collection of policy statements offered or actions performed by Federal Reserve authorities. The limitations imposed renders this inspection unavoidably sketchy. But it will be sufficient to bring out the major point in sharp focus.

*(1) The support policy in the period after World War II until the peak of 1948*

Until the "Accord of March 1951" between the Board and the Treasury, the Board was obliged to maintain a fixed yield pattern on the market for Government securities. This obligation has frequently been deplored by spokesmen of the System. In particular, more or less serious inflationary consequences were attributed to the support policy. We read thus:

In view of the recurrent heavy demands for funds during the period, these purchases had the effect of monetizing substantial amounts of Government securities, creating bank reserves and laying the basis for excessive credit expansion.<sup>11</sup>

Similar statements were made on other occasions. One may also observe that such statements effectively conveyed the impression to an outside public that the Federal Reserve was forced into inflationary actions under the support policy.<sup>12</sup>

What are the facts? Chart 2 supplies an incisive answer. From October 1945 until June 1947, the growth rate of the extended base collapsed from above \$7 billion per annum to below \$300 million per annum. It rose subsequently and hovered around \$700 million. During 1948, it fell rapidly and crossed to negative magnitudes in the middle of 1948. In the postwar period the Federal Reserve thus actually moved very rapidly in a deflationary direction. This posture is clearly reflected on chart 1 by the behavior of the money stock. Thus, irrespective of serious demerits inherent in a policy of support, it did not, contrary to impressions created by Federal Reserve descriptions, unleash inflationary impulses over the period considered. When Congress granted emergency powers to raise reserve requirements in August 1948, the growth rate had already crossed over into negative values and had been for more than 16 months below the long-run required rate.<sup>13</sup>

<sup>11</sup> Patman report, p. 346.

<sup>12</sup> We note in a recently published book covering Federal Reserve policy: \* \* \* "pegging Government security prices and yields not only prevented the Federal Reserve from using its powers to limit inflation but *actually became a substantial inflationary force itself.*"<sup>59</sup> Daniel S. Ahearn, *Federal Reserve Policy Reappraised, 1951-59*, New York 1963, p. 16. Emphasis supplied.

<sup>13</sup> It should be noted that among the answers to the questions submitted to the presidents of the 12 Federal Reserve banks and to be published in the study mentioned under the star footnote, the following acknowledgement can be found: "From the end of World War II to the time of the accord, open market operations on balance withdrew reserves (in several steps in 1949) from the banking system in an attempt to reduce excessive liquidity." But there is still no explicit acknowledgement that Federal Reserve policy had actually reached a deflationary posture in early 1947. It was the momentum of the previously accumulated money stock which carried the economy further to a peak in November 1948.



*(2) Federal Reserve policy during the recession of 1948/1949*

Economic activity reached a peak in November 1948 and the subsequent downswing continued until October 1949. Spokesmen for the System asserted that policy "shifted gears" in a direction to stimulate the economy. The System was described to have "acted promptly to adjust monetary and credit policy to the changed conditions of early 1949."<sup>14</sup>

How do the facts compare with the asserted "active countercyclical" policy? Once more, the reader is invited to ponder first chart 2 and then chart 1. In November 1948, the growth rate of the extended bases was around minus \$500 million per annum. It dropped even further to minus \$900 million in February 1949, rose slightly thereafter and oscillated around minus \$600 million until the end of the year. A decisive deflationary policy was the dominant mark for the whole downswing. There is no shred of evidence for any "active countercyclical policy." Chart 1 also shows that the money supply closely followed the behavior of the base. The operation of the currency factor, one of the other determinants of the money stock, decelerated its negative growth and led to an earlier upturn than for the extended base.

*(3) The monetary expansion of 1950*

The bottom was reached in October 1949. With the onset of recovery the Federal Reserve's evaluation shifted again. Open market transactions over the period beginning February 1950 and ending with June 1950 "were conducted so as to remove some of the stimulus to credit growth." Moreover, "the volume of bank credit and the money supply had continued to increase despite restraining action by the System". These statements, quoted from the annual report covering the year 1950, clearly convey the impression that Federal Reserve policy was more "restraining" in 1950 than in 1949, when policy was allegedly easy.

What happened actually? The growth-rate of the extended base accelerated over the first 6 months of 1950 by approximately \$850 million. In particular, it crossed the line into a positive range. It hovered and oscillated thereafter until nearly the yearend around \$250 million. In December 1950, it jumped by more than \$1 billion, initiating a pronounced and lengthy acceleration. We thus conclude that policy in the first 6 months was not restraining, it moved on the contrary in an expansive direction. Over the second half of the year, there are definite indications of an attempt "to hold the line."

*(4) The raise of legal reserve ratios in January 1951 and associated policy-assessments*

The outbreak of the Korean War imparted a considerable momentum to the U.S. economy and the Federal Reserve authorities became concerned about the inflationary potentialities. In late 1950 and early 1951, reserves became available to banks from various sources. In order to counter their expansive effect, the Federal Reserve raised the

<sup>14</sup> Annual Report of the Board of Governors for 1949. Even quite recently the Board still maintained that an "active countercyclical monetary policy" prevailed in 1949, "as would be appropriate under the Employment Act of 1946." The reader may find these statements among the answers to our questionnaire previously mentioned. The Federal Reserve authorities also asserted in the Patman report that the dominant policy of "ease" was at worst only "modified" by simultaneously occurring open market sales, p. 292.

legal reserve ratios.<sup>15</sup> Moreover, the Federal Reserve indicated that policy became increasingly "less easy" or "tighter" during 1951. Bank reserves were alleged to become "less readily available than they had been previously". "Reserve positions of commercial banks" were seen to be "under greater pressure in 1951 than in other postwar years." In short, the Federal Reserve's policy was described to be more "restraining" than in previous years. And the facts? Once more, the reader is invited to consult chart II. The growth-rate of the extended base moved around \$1 billion at the beginning of 1951 and accelerated to approximately \$2.2 billion per annum at the end of the year. There occurred thus a tremendous expansion which carried the growth-rate of the extended base to levels not experienced since the middle of 1946. This highly expansive posture mirrored by the growth-rate of the extended base, was effectively transmitted to the money supply.

(5) *Federal Reserve policy during the recession of 1953/1954*

According to the counting of the National Bureau of Economic Research, a peak was reached in July 1953. The lower turning point was passed in the following summer. Looking back over 1953, the Federal Reserve authorities described their own action in the following terms:

In recognition of the change in the economic \* \* \* situation, the Federal Reserve modified its credit policy with a view to avoiding deflationary tendencies. \* \* \* The System began early in May to increase the availability of credit by enlarging the supply of reserve funds.<sup>16</sup>

The Federal Reserve had successfully convinced itself that its policies were actively engaged "to avoid deflationary tendencies." Our observations determine a radically different situation. The growth rate of the extended base moved in January 1953 at a level of \$2.1 billion per annum and dropped throughout the year, with a hesitation in July, to a precarious low of only \$500 million per annum. Whereas the Federal Reserve thought to have "eased policy," the relevant policy indicator and major determinant of the money stock fell by more than 75 percent. The deflationary trend continued in 1954, somewhat attenuated, well into the summer. The actual movement of the policy indicator is again reflected by the behavior of the money stock (chart 1). We notice a persistent and sharp contraction in 1953 continued until April 1954. Once more, some other determinants contributed to accelerate the growth rate of the money stock while the policy indicator was still moving downward.

(6) *Federal Reserve policy during the recession initiated in 1960*

The momentum of the upswing beginning in April 1958 was soon smothered by an increasingly restrictive monetary policy. A peak was eventually reached in May 1960. According to the Federal Reserve's account the "policy of restraint on expansion of bank credit and money which carried over from 1959 was progressively moderated over the first half of 1960."<sup>17</sup>

<sup>15</sup> "These increases absorbed the additional reserves being made available at the time by a return flow of currency, a decline of Treasury deposits at Reserve banks, and Federal Reserve purchases of long-term Treasury bonds from nonbank investors \* \* \*." Annual Report for 1951.

<sup>16</sup> Annual report for 1953. The report also asserts that "The System in late summer and early autumn \* \* \* actively promoted credit ease with a view to avoid deflationary tendencies." A similar statement is repeated for 1954 in the annual report covering 1954.

<sup>17</sup> Annual report for 1960. The report also says about the period following the "early months" of 1960 that "monetary policy began actively to stimulate expansion."

A stimulative policy was thus perceived to hold for 1960. But the reader will notice, when inspecting the appended charts, that the collapse in the growth rate of the extended base, proceeding since February 1959 continued until April 1960. At this point, the growth rate was even negative and below any reasonable approximation to the desired long-run rate of growth. Until September 1960, the growth rate held around minus \$100 million. Policy shifted actually into an expansive gear only in October 1960. The growth rate of the money supply fell with the base throughout 1959. But it reached a nadir in May 1960, thus revealing the operation of other determinants (viz. currency factor) of the money supply, which offset the deflationary behavior of the policy dominated magnitude. An inspection of the actual circumstances thus indicates that the Federal Reserve authorities were pushing on the brakes while claiming to apply judicious pressure on the accelerator.

(7) *The pattern in postwar recessions*

Some general statements were made by spokesmen of the Federal Reserve System bearing on the relation between policy and cyclic phases. We may read, for instance, that in periods of recession "System policy is more likely to become positively stimulative rather than to remain the same." "At such times," it is asserted, the System shifts "to an active antirecessionary policy."<sup>18</sup>

What do the facts actually show? The following listing summarizes the relevant information for each postwar recession. The reader may check by inspection of chart 2.

(a) November 1948 to October 1949: Throughout this period the growth rate of the extended base is negative.

(b) July 1953 to August 1954: The growth rate of the extended bases collapsed from approximately \$1.4 billion per annum to around \$200 million per annum.

(c) July 1957 to April 1958: The growth rate of the base fell below zero until November and stayed around zero until February 1959.

(d) May 1960 to February 1961: The growth rate of the extended base remained negative for the first 3 months of the recession. Even at the end of the year the rate was still more than 50 percent below the desired long-run rate of growth.

These facts yield little support for the contention advanced by the Federal Reserve authorities. Actual policy was either actively deflationary or moving in a deflationary direction, or, as toward the end of 1960 insufficiently expansive.

#### AN EXPLANATION OF ACTUAL POLICY BEHAVIOR

The astonishing discrepancy between actual and professed policy attitudes discussed in the previous sections requires an explanation. Such an explanation has been provided in the study prepared for this committee. It is argued there, that the peculiar circumstances shaping the Board's procedures have channeled attention to the very shortest run evolutions of the credit markets. The Board's conceptions have been decisively influenced by the daily and weekly fluctuations on the

<sup>18</sup> Part 2 of answer to question V supplied by presidents of the 12 Federal Reserve banks.

“money markets.” This short horizon made it very difficult to detect the pattern of systematic associations working in the process. These patterns are drowned by the “random noises,” which typically dominate the shortest-run fluctuations on the markets continuously watched by the Federal Reserve officials. On the other hand, an attention span extending beyond a few weeks and covering at least a month already permits us to focus more sharply on the systematic structure underlying the whole process. But the Board’s routine tends to limit the time span of the attention. This situation entails that substantially greater discretionary power is actually delegated to the Account Manager than is formally acknowledged. Our detailed investigation, summarized in the study indicated above, led us, moreover, to the conclusion that policy changes have frequently been initiated by the Account Manager and were subsequently supported by a suitable consensus of the Federal Open Market Committee.

CHART 1

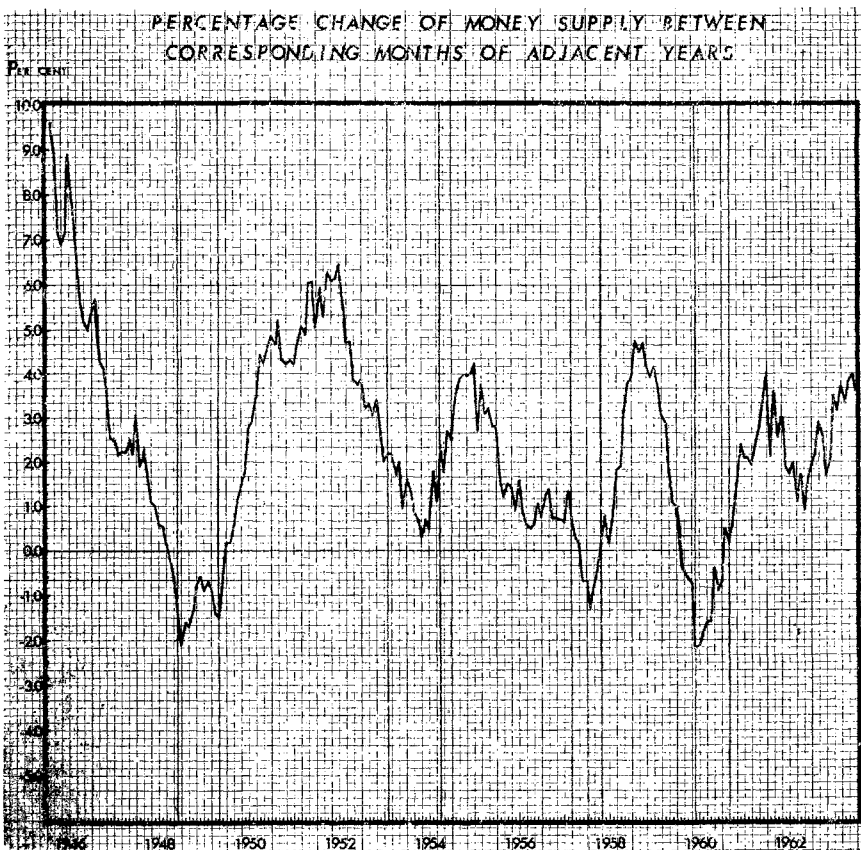

SOME PROPOSALS

1. Continue the growth rate of the money supply achieved by the end of 1963. There are still unutilized resources which could be absorbed into current activity by monetary expansion. This requires a

CHART 2

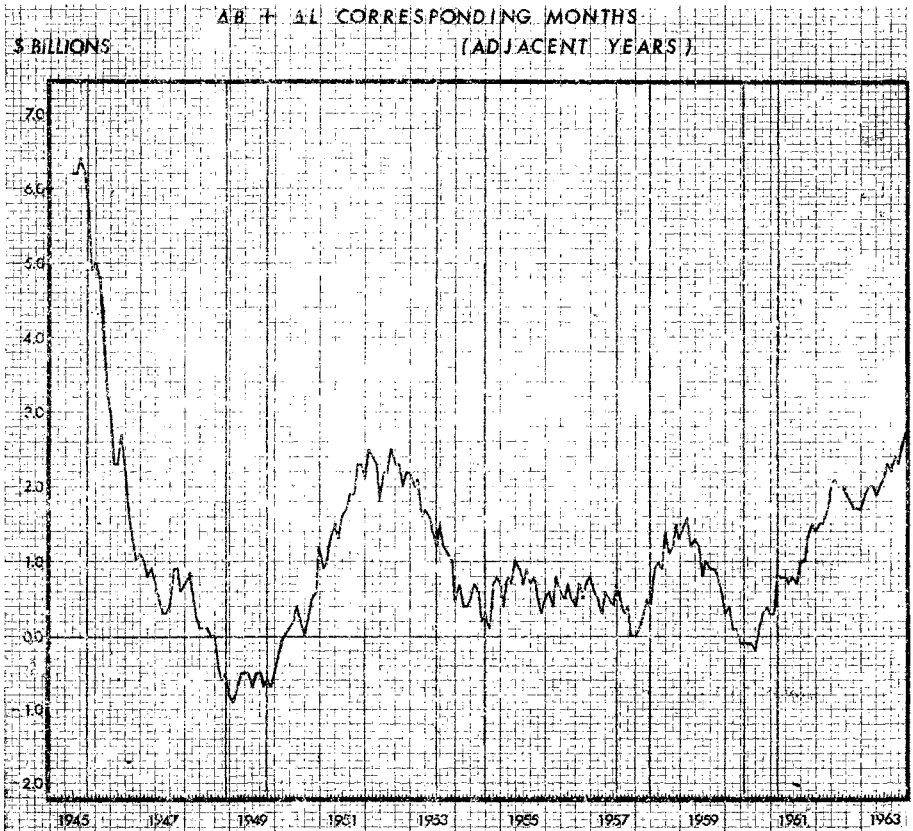

growth rate at a comparatively higher level to be maintained over some time period. It should also be emphasized that expansive monetary policy could not be expected to absorb a major portion of total existing unemployment.

2. Stabilize the growth rate of the (extended) base. The gyrations observed in the past have no rationale. They may be anachronistic residues of confused notions bearing on "needs of trade" and "elasticity." Actually, they only amplify economic fluctuations.

3. Variations in the growth rate of the base should take account of other major determinants of the money supply, in particular, the currency flows between public and banks.

4. More effective utilization of the Board's research facilities. The Board's research division has performed excellently in the collection and preparation of data. But these data were not effectively exploited by the Board. In particular, major policy decisions should not be founded on anecdotal impressions, but on carefully executed and validated pieces of analysis. The Board has potentially the facilities available to broaden its systematic knowledge about the structure of monetary processes.

5. Annual report should carefully explain the effect of policy actions on money supply and credit markets. This requirement would be designed to aid in channeling the Board's attention beyond the "random noises" of the shortest horizon.

6. Abolish the Federal Open Market Committee. This Committee is too cumbersome and unwieldy. There is no indication that it operates to supply decisive guidelines to the Account Manager.

7. Consolidation of policy in the Board and smaller size of Board. The Board should be reduced to at most four members. All policy decisions are to be made by the Board. Furthermore, most of the routine work currently to be dealt with by members of the Board should be delegated to administration officials in the higher echelons. Such delegation would enable the Board to allocate more time to basic policy issues.

8. Adjust length of membership tenure to presidential term with possibility of repeated reappointment.

9. Either abolish discounting or make it a right to be granted every member bank for any desired amount and frequency of occurrence, willing to meet the collateral conditions and the discount rate.

Under the second choice, the discount rate would have to be a "penalty rate." Suitable manipulation of the discount rate, relative to market rates, can effectively modify the Federal Reserve's portfolio of discounts and advances without application of administrative pressures and discretionary procedures.

The CHAIRMAN. Now, Professor Brownlee, you may proceed, sir.

**STATEMENT OF O. H. BROWNLEE, PROFESSOR OF ECONOMICS,  
UNIVERSITY OF MINNESOTA**

Mr. BROWNLEE. Thank you. I will direct my comments more directly to the specific bills which are being considered at the present time.

The CHAIRMAN. Yes, sir; we wish you would.

Mr. BROWNLEE. In general, I am enthusiastic about the proposal to eliminate the prohibition against paying interest on demand deposits. And, of course, I wish you would go further and also remove the ceilings on interest rates to be paid on time deposits as well. I think this is the most important of the five proposals. I also feel that it is desirable for banks to be permitted to treat Government as it treats any other depositor, that is to pay interest on its deposits and also to levy charges for service.

I believe that it is desirable to grant banks membership in the Federal Reserve without requiring that they hold stock. However, I don't consider the difference between this and present arrangements to be very important.

The other two proposals, I take it, are designed primarily to reduce the independence of the Federal Reserve System; that is, you want to take away their independent income so they will have to come directly to Congress for appropriations, and you also wish to make the Chairman of the Board the Secretary of the Treasury.

I assume the latter proposal is designed to try to introduce more coordination between monetary policy and fiscal policy.

I don't think that spectacular changes would necessarily result if these proposals were accepted. I think it is a basic change in our concept of monetary policy rather than an organizational change which is required in order to achieve the results which I think you are seeking.

While I agree that the Open Market Committee has performed much in the way in which Professor Brunner has just described, in general I find it quite difficult to understand what the Open Market Committee is trying to do, meaning what instructions it gives to the New York desk and what procedures it uses to see whether or not its instructions are being carried out.

I also believe that using as targets free reserves can result in exactly the kind of behavior of our monetary supply which Professor Brunner has just described; that is, one can have many different levels of total reserves for any given amount of free reserves, and the first change that ought to be made is to forget about free reserves as a target and look at the total of bank reserves.

I don't think necessarily that making the Secretary of the Treasury the chairman of the board is going to bring about this difference.

I also happen to be among a group led, I believe, by Professor Friedman, of the University of Chicago, and Professor Shaw, of Stanford University, who believes that it would be desirable to follow a policy of increasing our money supply at a constant rate, say 3½ to 4 percent per year, in which case not only should the Open Market Committee be changed, but its function as such could be abolished. We would not need a committee to perform the functions such as the Open Market Committee is supposed to be performing.

I will terminate my oral statement here and permit you more time for questioning.

The CHAIRMAN. All right, sir. I notice you didn't pass on the other bills.

Mr. BROWNLEE. Well, I don't consider myself to be an expert in these areas.

(The prepared statement is as follows:)

STATEMENT OF O. H. BROWNLEE, PROFESSOR OF ECONOMICS, UNIVERSITY OF MINNESOTA

I have been requested to offer my opinions with respect to five bills affecting the organizational structure of the Federal Reserve System and to comment on the desired level of interest rates and money supply at this juncture in economic activity.

In general, I support the proposals to (1) grant banks membership in the System without requiring them to hold Federal Reserve stock; (2) eliminate the prohibition against the payment of interest on demand deposits; and (3) permit banks to pay interest on deposits made by the Treasury and charge for services rendered to the Treasury. I have no strong opinions on the proposals to return interest received by the Federal Reserve banks on obligations of the United States to the U.S. Treasury nor on the proposal to enlarge the membership of the Federal Reserve Board, make the Secretary of the Treasury its Chairman, abolish the Open Market Committee, create a Federal Advisory Committee, and so forth. The latter appear to be designed to make Federal Reserve operations more effective as devices for economic stability, but I believe that reforms in basic policy rather than only

in organization are needed, if the system is to maximize its contribution to the economy.

In order for a central bank to perform its primary functions of (1) providing a market for bank assets, particularly in the event of an increase in the public's demand for cash, thereby avoiding such decreases in the money supply as occurred during the early 1930's; and (2) buying or selling certain assets in accordance with some pre-determined rule in order to alter banks' reserves which in turn will alter the money supply, it is not necessary for the member banks to have any financial interest in the central bank. Rediscounting was performed by large banks in central cities prior to the creation of the Federal Reserve System, and this may be responsible for the conception of a central bank along the lines of a private bank. The requirement that member banks hold stock and share in the profits or losses of the Federal Reserve appears to me to be a silly one.

Many analysts of monetary policy have been critical of the degree of independence of the Federal Reserve banks from the President and Congress, and I assume that the proposals in H.R. 9631 and H.R. 9685 are designed to reduce this independence. Requiring that interest received by Federal Reserve banks on U.S. obligations be returned to the Treasury would eliminate the Federal Reserve's financial independence and force it to obtain congressional appropriations. I see no overriding objections to this providing that the activities of the System rather than its actions are scrutinized in determining appropriations. It would be highly undesirable for a tight-money Congress to approve the budget of the Board and the banks if interest rates happened to be high or to cut it if rates were low, for example.

This change, as well as making the Secretary of the Treasury the Board's Chairman, abolishing the Open Market Committee and creating a large Advisory Committee, will not bring fundamentally improved performance to monetary management. When monetary policy has been tailored to the desires of the Treasury, as it apparently was in World Wars I and II, during the depression of the thirties and in the post-World War II period, it has been basically more expansionary than when the Board has had control. This is not necessarily good, unless we consider inflation to be a good thing. Our principal difficulties, however, have been with the variability of the rate of change in the supply of money. Some of this may have been planned. There are many persons who believe that changes in the money supply can be used to reduce fluctuations in economic activity. However, some of it appears to me to be unplanned. I confess that I cannot determine from the record what the Open Market Committee was attempting to achieve, the directions which it gave to those who were charged with gaining the objectives nor the criteria used to determine if what was obtained was approximately the same as that which was sought. Nevertheless, I am certain that many different levels of total reserves, and hence of the potential money supply, can exist with a given amount of "free reserves"—the target variable used by the Committee. An increase in free reserves can be compatible with an increase or a decrease in the potential money supply. Regardless of its composition, the body in charge of open market operations should operate on total reserve rather than free reserves.

I also believe that trying to smooth out business fluctuations by changing the rate of change in the money supply leads to greater



fluctuations than otherwise would occur. Stated another way, our monetary activities have contributed to economic instability not only because of using the wrong targets but also because of acting as if the future could be known more accurately than we can now predict it. Direct evidence in support of this belief is hard to obtain. But, so is evidence against it. And, the indirect evidence combined with accepted theory favors a policy of increasing the money supply at a constant rate. This permits setting clearly targets for total bank reserves relatively far into the future. The Open Market Committee not only can be abolished; its function can be abolished as well.

I am unreservedly in favor of abolishing the prohibition against the payment of interest on demand deposits, and I also favor eliminating the ceilings on interest rates payable by commercial banks on time deposits, although the latter is not now being considered. These regulations hark back to the depression of the thirties when it was believed that the way to make "safe" banks was to reduce bank competition for deposits and thereby induce banks to make less risky loans. The wholesale failure of banks during the thirties was due more to the irresponsibility or bad judgment of the monetary authorities than to the risks of the investments. This, however, is irrelevant. I would expect no more risks under free interest rate than with rates that are controlled for several reasons.

First of all, a bank interested in maximizing expected profit subject to such portfolio restrictions as are imposed by laws and bank examiners would allocate a given amount of loanable funds among various opportunities in a given way regardless of what it had to pay to secure these funds, just as a profit maximizing business would choose the same bundle of goods to produce from a given bundle of resources independently of the cost of the resource bundle.

Secondly, because interest ceilings prevent the commercial banks from using interest rates in competing with other banks for funds, the commercial banks loan less than otherwise would be the case. More funds are loaned by other types of financial institutions. I do not believe that the loans made by these other institutions are less risky than those that would have been made by the commercial banks.

Finally, although commercial banks are denied the right to use interest rates to compete with each other and with other financial institutions, they can compete in other ways. Advertising, premiums for opening or augmenting accounts and services offered to depositors at fees below their costs are the principal forms of such competition. If it were true that the riskiness of loans were related to the costs of obtaining funds, risk would not be significantly affected by the interest ceilings if cost were not significantly affected.

The social losses which result from the interest rate ceilings imposed on deposits probably are not very large. However, there is little point in incurring them. Present arrangements result in (1) lower service charges on small deposits than otherwise would be the case, (2) higher costs to larger deposits, and (3) a larger component of services in lieu of interest payments. This latter category represents income that is not subject to income tax. Converting some of it to income subject to tax represents an important byproduct of removing the prohibition.

Even though it may discredit the sensible things I have said about interest ceilings, let me conclude my remarks on this subject by saying

that I believe that commercial banks have been permitted to take too few risks and that there have been too few bank failures. The control of commercial banking has made it into an industry comparable in stodginess to the railways (the responsibility for the status of the latter probably can be traced to the ICC).

More failures probably would raise FDIC rates—a feature which would not be welcomed by all bankers. However, just as it is nonsense to grant all auto drivers insurance at the same rates regardless of differences in their abilities to handle cars or to make life insurance rates independent of the states of health of the insured, it is not optimal to charge the same deposit insurance rates to all banks. Rates on deposit insurance could be classified according to risk and the status of the bank be made known to all potential depositors. No subsidy given by “safe” banks to risky ones—as can be the case under existing arrangements—need result.

An unregulated insurance company which was a monopoly would find it in its interest to grade its rates according to risk. In a competitive industry, such gradation would be virtually inevitable. The FDIC appears to be an unimaginative monopoly, partially because it is not interested in maximizing profit, but more important because for most banks insurance with the FDIC is compulsory. Perhaps other insurers should be permitted to enter the field of deposit insurance to help keep the FDIC on its toes.

#### IS THE MONEY SUPPLY SUFFICIENTLY LARGE?

Since the “accord” between the Treasury and the Federal Reserve (1951), the average annual rate of growth in the money supply has been about 2 percent. Percentage increases were considerably larger than this average during the last 3 years as a result of augmenting bank reserves through permitting banks to count vault cash as a part of their reserves and as a consequence of reduced reserve requirements for time deposits. If increases in the money supply were the only demand expanding device, an annual average rate of increase of 2 percent is too small to keep the price level constant with real output growing at 3 percent or more per year (or to keep output growing at 3 percent per year at a price level which cannot be reduced). Federal cash payments to the public exceeded receipts, thereby increasing the Federal debt and adding to aggregate demand. State and local borrowing also increased substantially. The result is a level of interest rates higher than would have prevailed had there been smaller increases in debt and larger increases in the money supply.

I believe that the money supply could have been expanded faster than it was, given the fiscal situations of the various governmental units, without significant price increases. Many persons believe that the real gross national product has been from 3 to 5 percent below that which could be produced without inflation for nearly 7 years. However, I do not hold the Federal Reserve wholly responsible for our monetary policy. The outflow of gold from the United States—as a result of foreign economic aid, military assistance, private U.S. investment abroad particularly in common market countries where it was expected that U.S. produced goods could enter under increasingly less favorable terms, and prices for the dollar that have been too high in

terms of foreign currencies—was given undue weight in determining the desired interest rate levels.

The U.S. economy could function without impairment on much smaller gold reserves than we have. However, steps have been taken to try to diminish the outflow of gold. The most important of these has been toward maintaining sufficiently high rates of interest to induce foreigners not to convert their claims against us into gold rather than adjustments in the fundamental factors. In fact, it has been argued that the short-term rate can be pushed up and the long-term rate down, thereby reducing gold outflows and encouraging domestic investment. Although it is not of relevance to the present discussion, I believe that the spread between long- and short-term rates cannot be altered significantly within the range of action available to the Treasury. Reductions in long-term accompanied by increases in short-term Government debt will be approximately countered by relative increases in long-term and decreases in short-term private debt (including that issued by foreigners).

The cut in Federal taxes will make both the gross national product and the level of interest rates higher than would have been the case had no action been taken. Although I do not know precisely at what level of gross national product the Federal budget will balance, my guess is that it is near the desired value and that increasing the money supply at a rate in excess of 3 percent per year to reduce interest rates would now be inflationary.

For a given desired gross national product, we have a choice between easy money and a tight budget (a surplus) or tight money and an easy budget (a deficit). We have chosen the latter policy. I do not know how important the difference between the two policies would be in terms of economic growth. The course we have chosen pushes consumption and Government spending at the expense of private investment. An easy-money policy—if it is not to be inflationary—pushes private investment at the expense of consumption. Such fundamental choices should be made by the Congress. I hope that it knows what kind of choice it has made.

The CHAIRMAN. Very well. Now, first, I want to ask Dr. Brunner a question.

Suppose, Dr. Brunner, that in the years since 1953 the Fed had used open-market purchases to raise the quantity of money instead of having lowered reserve requirements. Would we have had substantially more inflation, less unemployment, and less economic growth than we did have these past 11 years? In answering you may assume that the money supply's behavior would have been the same as it was.

Mr. BRUNNER. Some of the results accumulated in our research project bear quite immediately on this question, Mr. Chairman. We investigated in particular the response of the money supply to variations in the legal reserve ratios and to open-market operations. The comparatively frequent changes in the legal ratios which occurred in the postwar period fortunately permitted a careful examination of both requirement policy and open-market policy. We found that the money supply responded by essentially the same order to open-market operations of a given volume or to changes in the same volume of required reserves resulting from variations in legal reserve ratios.

In particular, according to the statistical investigations performed, open-market purchases of \$1 billion or a reduction in requirement ratios which liberates \$1 billion of reserves from required reserves, generate essentially the same response of the money supply. It follows, therefore, that the behavior of the money supply actually observed since 1953 could have been obtained under unchanged requirement ratios with suitably chosen open-market operations. Moreover, under the circumstances specified in your question, Mr. Chairman, the substitution of open-market operations for changes in legal reserve ratios would have induced no significantly different experience in either unemployment, inflation, or economic growth.

Open-market operations can thus effectively substitute for changes in requirement ratios. The appropriate future growth of the money supply requires, therefore, no discretionary powers by the Federal Reserve authorities over the requirement ratios. Once the authorities understand the structure of the money supply process, open-market operations supplemented with suitable adjustments of the discount rate are sufficient to assure an adequate control over the money supply and to generate its required long-run growth.

The CHAIRMAN. I will ask you another question. Then I will want the comments of Professor Brownlee.

If we had used open-market purchases to expand the money supply, wouldn't the debt held by the Federal Reserve be much higher today than it is, and so the actual interest paid by taxpayers much less?

Mr. BRUNNER. I didn't quite understand.

Did you address it to me or Dr. Brownlee?

The CHAIRMAN. Well, let me read it again. I am anxious for you to answer this.

If we had used open-market purchases to expand the money supply, wouldn't the debt held by the Federal Reserve be much higher today than it is, and so the actual interest paid by the taxpayers much less?

Mr. BRUNNER. The answer is "Yes." In case the Federal Reserve authorities maintain the legal reserve ratios at a constant level, the required long-run growth of the money supply would have to be achieved by suitable open-market purchases. Such purchases undoubtedly lower the outstanding effective debt, that is, the interest-bearing debt held outside the economy's Government sector.

Under a system of fixed requirement ratios monetary policy would thus unavoidably operate as a built-in retirement process which contributes to reduce gradually the effective debt of the U.S. Government. The order of magnitude of this built-in retirement process can be usefully specified. If the Federal Reserve authorities had maintained the legal reserve ratios since January 1953 at a constant level, approximately \$5 billion more open-market purchases would have been necessary to generate the growth-behavior of the money supply which we actually experienced.

It should be noted in this context, however, that both average growth rate and cyclic behavior of the money supply were inadequate in the postwar period. In particular, the average growth rate was too small from 1953 to 1962. I would contend that the rising rate of unemployment and the retardation of economic growth were associated with this unnecessarily constraining monetary policy. An appropriate policy will have to assure for the next 10 years a growth rate of the money supply averaging 3 to 4 percent per annum. Such a policy would

imply a growth rate of the monetary base between 3 and 4 percent per annum, provided the other determinants of the money supply remain unchanged. The open-market purchases necessary to yield such a growth rate would lower the effective interest-bearing debt of the U.S. Government by approximately \$20 billion over a 10-year period. However, if the currency patterns observed over the postwar years persist, then a larger growth rate of the monetary base may very likely be necessary to generate the required long-run growth of the money supply.

The CHAIRMAN. Would you like to comment, Professor Brownlee, on those questions?

Mr. BROWNLEE. Well, let me see if I understood the first question.

Did you ask, Does it make any difference as far as economic activity is concerned, whether we get the desired money supply through changes in reserve requirements or through open-market operations?

The CHAIRMAN. That is right.

Mr. BROWNLEE. The answer is no, it doesn't, as far as I can see.

The CHAIRMAN. And the second one now.

Mr. BROWNLEE. Well, it depends on what you mean by much. It is true the total debt in the hands of the public would be smaller, and that in the hands of the Federal Reserve would be larger if the money supply could be expanded by open-market purchases. Open-market operations are a way by which we can convert the debt which is interest bearing to debt which is noninterest bearing.

The CHAIRMAN. Let me bring up an entirely new question.

If you gentlemen have not given consideration to it, you may say so.

It occurs to me that when the Open Market Committee takes Federal Reserve notes, and buys U.S. Government bonds they take Federal Reserve notes, which is one Government obligation, and trade them for another Government obligation, an interest-bearing obligation and it it occurs to me that that cancels that debt, when it is acquired. Of course I know the Committee does it for the purpose of having open-market operations. But if we take Professor Brownlee's suggestion, we wouldn't have the type of operation that we have now. We would do it probably a different way.

It occurs to me that that cancels that debt. And if we say it should still be kept alive for open-market operations, should the taxpayers be compelled to continue to pay interest on it? It has been paid once.

What do you think about that, Dr. Brunner?

Mr. BRUNNER. Your question, Mr. Chairman, seems to bear on the issue whether or not the Federal Reserve's open-market purchases effectively lower the volume of interest-bearing debt and thus lower the volume of tax receipts required to finance interest payments.

The CHAIRMAN. That is right.

Mr. BRUNNER. The Federal Reserve banks currently receive interest on their portfolio of Government securities. These earnings appeared usually more than sufficient to cover the Federal Reserve's costs of operation. A major part of the emerging profits seems to have been transferred to the Treasury. This transfer effectively reduced the volume of tax receipts required to finance interest payments on the national debt. The tax receipts still necessary to finance the remaining net payments on the Federal Reserve's portfolio of Government securities must, therefore, be understood as the taxpayers' contribution designed to finance the operations of the Federal Re-

serve banks. The taxpayer thus finances in this manner a Government agency outside the usual budgetary controls provided by our constitutional processes.

The effect of different types of monetary policy on the use of tax receipts for interest payments on the effective debt may be further clarified. If the Federal Reserve authorities had expanded the money supply since 1953 to the extent actually observed by relying solely on open-market operations, the interest payment on the effective debt would currently be lower by approximately \$150 to \$200 million. Moreover, should the monetary base expand over the next 10 years in accordance with the longrun growth requirements of the money supply, the interest payment on the effective debt at the present level could be reduced by approximately \$800 million until 1974. This computation presupposes, however, that the Federal Reserve's operational costs are not expanding *pari passu* with the increase in its portfolio of Government's securities. Apart from salary increases and in the absence of wide-flung ramifications of new activities engaged in by the Federal Reserve System, only a very small part of the \$800 million could be reasonably expected to cover increased operational costs. An appropriate growth policy under constant requirement ratios could, therefore, be expected to lower significantly the volume of tax receipts necessary to cover interest payment on the effective debt.

The CHAIRMAN. Let me change it just a little bit.

Do you believe that the amount that is acquired in the manner I have indicated should be considered a part of the national debt? Why shouldn't we say that the amount of bonds in the Federal Reserve open-market portfolio should not be considered in arriving at the total amount of the national debt?

Mr. BRUNNER. The combination of the Federal Reserve's portfolio of Government securities with the total volume of such securities held outside the Government sector is rather arbitrary and can also be quite misleading. The decisive amount is the volume of U.S. debt held outside the Government sector of the economy. For proper information the debt held by the Federal Reserve System should be listed separately. Such presentation would make it more explicit that the U.S. debt held by the Federal Reserve is either a mere book-keeping device without economic significance or a device to coerce taxpayers to share the operational costs of our monetary authorities.

The CHAIRMAN. Professor Brownlee, would you like to comment on that question?

Mr. BROWNLEE. I think your statement is essentially correct. That is, when we trade non-interest-bearing Federal debt—Federal Reserve debt—for interest-bearing Federal debt, we are in effect canceling that portion of the debt. But what we include as debt, I think, is somewhat arbitrary.

I suppose we actually should include money. But for the most part, we call debt only that portion which bears interest. And it is in this sense that under your proposal, if the Federal Reserve were to turn its earnings over to the Treasury, open-market operations will effectively cancel a portion of the interest-bearing Federal debt.

The CHAIRMAN. I considered a bill at one time—I am not sure I introduced it—to require that in determining the amount of the public

debt, the national debt, the amount of bonds held by the Open Market Committee in the Federal Reserve banks would not be considered.

Now, of course, that would mean if they have \$34 billion now, there would be \$34 billion less national debt on the books.

But if for any reason they would sell \$4 billion, the debt would go up by that amount. In other words, just the amount in the open-market portfolio would be considered not part of the debt.

Would that be reasonable enough, Mr. Brownlee?

Mr. BROWNLEE. Well, why are you interested in knowing the total amount of the debt anyway?

The CHAIRMAN. Well, that has become very important. It is psychological, I know.

Mr. BROWNLEE. Yes. As far as the debt ceiling that is imposed by Congress is concerned, I think you are correct.

One should not include in this the amounts which are held by the Federal Reserve. But I think the important thing is to know where the debt is—that is, how much debt is in the hands of the public, how much is in the hands of the Federal Reserve, and how much is in the hands of other Government agencies.

We speak of a total debt of approximately \$300 billion. Actually, only about half of this is really in the hands of the public.

The CHAIRMAN. Would you like to comment, Dr. Brunner, on the last statement I made about having a debt policy written into the law, that in arriving at the national debt that the amounts of bonds held by the Open Market Committee would not be made a part of the national debt?

Mr. BRUNNER. A clear separation of the Federal Reserve System's portfolio of Government securities from any specification of the national debt may actually contribute to a clearer understanding of monetary problems.

Government securities held outside the Government sector by commercial banks and the public play a radically different role in the monetary processes than the Federal Reserve's portfolio of Government securities. Some of the tables occurring in Federal Reserve publications combine U.S. debt held by commercial banks and Federal Reserve banks as elements of a uniform category. This procedure unavoidably generates serious misconceptions about the role of U.S. debt in the monetary process and beclouds the proper interpretation of the Federal Reserve's portfolio of Government securities. I submit, therefore, that a specification of "national debt" in terms of U.S. debt held outside the economy's government sector would be useful.

The CHAIRMAN. Mr. Brock?

Mr. BROCK. Thank you, Mr. Chairman.

Mr. Brownlee, if I might just cover a couple of points on the specific bills involved.

On the bill which would place the Federal Reserve under the Secretary of Treasury, in effect, as I understand it, you say this will bring no fundamental improvement in performance. In other words, I am interpreting—I would say that you are not particularly in favor of this bill.

Mr. BROWNLEE. Well, I am neither opposed to it nor in favor of it. I am essentially indifferent to it.

That is, I don't think that a Secretary of the Treasury unnamed is necessarily a wiser man than a Chairman of the Federal Reserve Board unnamed because we can find some Secretaries of the Treasury who have been wiser than certain chairmen of Federal Reserve Boards, but one cannot be assured that this will essentially be the case.

And it is a fundamental change in the nature of monetary policy, rather than a change in the organization, which is required, I think, to achieve the objectives which we have in mind.

Mr. BROCK. Well, one of the points you raised here, on this second page—

it would be highly undesirable for a tight money Congress to approve the budget of the Board and the banks if interest rates happened to be high or to cut it if rates were low, for example.

What you are saying is that you are concerned over the political impact it might have on monetary policy.

Mr. BROWNLEE. Exactly. I think it is not the actions as such of the Federal Reserve which ought to determine the size of its appropriation. It is its function as such. And, on this score, I am a little bit wary about requiring the Federal Reserve to come to Congress for an appropriation.

Mr. BROCK. Wouldn't the same thing be true—would it not be subject to political pleasures and whims in the changes of the political climate? For example, if a tight money administration were supplanted by a loose money administrator, or vice versa—would it not be in opposition to your approach to monetary affairs? You want a stable approach. If he were subject to the Treasury, wouldn't this defeat your purpose, when you had a change?

Mr. BROWNLEE. Administratively it certainly appears the way to do this. You know more about what kinds of pressures are brought to bear and are more of an expert on this question than I am.

Mr. BROCK. Well, I am raising the question because I think there are these pressures, and under a situation where there were, don't you think it would be undesirable?

Mr. BROWNLEE. If I were forced to commit myself, I think the answer would be yes.

Mr. BROCK. Professor Brunner, if I may ask you a couple of questions on these charts, please, sir.

You say that the first page, on 1948-49—

Mr. BRUNNER. Pardon me, sir. Are you referring to chart 1 appended there?

Mr. BROCK. Yes.

Mr. BRUNNER. Yes, sir.

Mr. BROCK. You say that this period from 1948 to 1949 reflects active deflationary policies on the part of the Fed.

Mr. BRUNNER. That is what I said, yes.

Mr. BROCK. All right.

Now, would you explain to me what you mean by the peak—the peak of what? This first line, in the latter part of 1948, about November of 1948. It shows a period which you label as a peak.

Mr. BRUNNER. The graph appended to the written statement before you contains also the same vertical line centered on November 1948.

Mr. BROCK. This vertical line here?

Mr. BRUNNER. The vertical line centered on November 1948 and labeled "peak" indicates that aggregate economic activity has reached



a peak at the month specified. The National Bureau of Economic Research has developed an intricate routine to determine the turning points in the pace of economic activity. The specifications worked up by the National Bureau are quite generally used in our profession to locate the upswings and downswings of our economic fluctuations. These very specifications were used to locate the peaks and troughs in the graphs appended to the statement. According to the timetable charted by the National Bureau, economic activity began to decline in November 1948 and reached bottom in October 1949.

Mr. BROCK. Now, following through, the second line is the trough of economic activity.

Mr. BRUNNER. Yes, sir.

Mr. BROCK. Now, you say that the Fed, looking at the trend of your jagged line here—the trend line—

Mr. BRUNNER. Yes.

Mr. BROCK (continuing). Shows a deflationary policy.

Mr. BRUNNER. That is right.

Mr. BROCK. From the peak to the trough.

Mr. BRUNNER. I beg your pardon?

Mr. BROCK. From the peak to the trough.

Mr. BRUNNER. That is right.

Mr. BROCK. In other words, while we were going down we were still exercising deflationary policy.

Mr. BRUNNER. That is right. The Federal Reserve pursued an actively deflationary policy throughout the downswing in economic activity.

Mr. BROCK. All right.

Now, taking the last two pages of the 1960 to 1961 peak and trough—

Mr. BRUNNER. Yes.

Mr. BROCK (continuing). You have from the peak to the trough a fairly substantial increase in the trend line.

Mr. BRUNNER. Chart 1 or chart 2?

Mr. BROCK. This is still the same chart 1.

Going from the peak of economic activity to the trough, you have an expansionary monetary policy.

Mr. BRUNNER. You refer to the growth rate of the money supply depicted on chart 1. This growth rate reached a nadir immediately following the peak of economic activity. But you should notice, sir, that the growth rate was negative, and while it accelerated throughout the downswing, remained negative for a portion of the recession. After the unnecessary collapse of the money supply's growth rate in 1959 and early 1960, it moved at least in the right direction throughout the deflationary phase of 1960-61. Unfortunately, this increase in the growth rate of the money supply was not achieved by courtesy of the Federal Reserve authorities. Inspection of chart 2, which depicts the growth rate of the extended base, clearly reveals that Federal Reserve policy remained substantially deflationary for a major portion of the recession. The growth rate of the extended base, which effectively summarizes the actual policy behavior of the Federal Reserve authorities, remained negative until late in 1960 and was still much lower than the required longrun growth rate at the close of 1960.

The accelerated movement of the money supply initiated in late spring of 1960, and persisting during the downswing, was caused by

the behavior of the other determinants of the money supply. In particular, the reallocation of the public's money balances between currency and checking deposits contributed to retard the decline in the money supply and offset partly the deflationary impulses imparted on the monetary system by Federal Reserve policy. During every recession we note a backflow of currency from the public, a relative decline in the allocation of the public's money balances to currency. This behavior on the part of the public initiated together with some other forces the increase in the growth rate of the money supply in 1960, months before the growth rate of the extended base (on chart 2) reveals a reversal of Federal Reserve policy in an expansionary direction.

Mr. BROCK. All right. Then your statement that the chart reflects deflationary activity in one area, and expansion activity in the other, is not a reflection of the policy of the Fed, but is a reflection of the actual money supply, which has no relationship to the policy?

Mr. BRUNNER. I am not quite sure that I understood your question correctly; I am sorry.

Mr. BROCK. Well, you said during your testimony that the first chart showed a deflationary policy of the Fed.

Mr. BRUNNER. That is right.

Mr. BROCK. But the last chart—which is the same chart, but 14 years later—you say it doesn't reflect any policy at all, that it reflects the actual conditions in the money supply. Now, you are talking apples and oranges, Professor.

Mr. BRUNNER. Are you referring to this period again, sir? To this period in 1960-61?

Mr. BROCK. That is right.

Mr. BRUNNER. In order to clarify this issue, I wish to emphasize once more that chart 2 describes the growth rate of the extended base, summarizing the actual policy behavior of the Federal Reserve. It is also the most important determinant of the money supply's growth rate depicted in chart 1. But you will note, sir, that, while the extended base is the most important, it is not the only determinant of the money supply. A few other factors contribute to shape the behavior of the latter magnitude. Foremost among these other factors is the partition of the public's money balances between currency and checking deposits.

An inspection of chart 2 clearly reveals that, over the first 4 or 5 months of the recession initiated in 1960, the growth rate of the extended base was negative. During this phase, the Federal Reserve authorities engaged in an actively deflationary policy. Later in the downswing, the growth rate of the base became at least positive. During 1961, policy became decisively expansionary, hesitated seriously for some months in 1962, and moved further to generate a growth rate of the base in the late fall of 1963 not achieved since 1952. This prolonged and decisively expansionary policy is quite likely one of the single most important reasons explaining the length and vitality of the current upswing in economic activity.

You indicated correctly that the money supply behaved somewhat differently than the base during the recession of 1960-61. Its growth rate hit a nadir immediately after the peak in economic activity, and many months before the growth rate of the base revealed an attenuation of the Federal Reserve's deflationary policy. The other deter-

minants of the money supply worked to offset the Federal Reserve's policy behavior. In particular the public's currency behavior modified the Federal Reserve's deflationary posture. This modification is effectively revealed by the comparatively early turning point in 1960 for the growth rate in the money supply. A comparison of the two charts clearly exhibits this point.

Mr. BROCK. I appreciate that. I was just trying to clear up a false impression I got.

Mr. BRUNNER. I hope I was responsive to your question, sir.

Mr. BROCK. Yes; I think you were responsive.

Let me follow through, then. What do you think constitutes Federal Reserve monetary policy? Is it the rediscount rate? What particular actions are you using as an index of their inflationary-deflationary activities?

Mr. BRUNNER. Your question involves several parts, and bears on the description of the policy indicator labeled as the extended base and whose growth rate is depicted on chart 2.

Monetary policy is exercised by the Federal Reserve authorities through open-market operations, changes in legal reserve ratios, and variations of the discount rate posted by the Federal Reserve banks. The index used to summarize Federal Reserve policy effectively combines all the policy actions of the Federal Reserve authorities into a single magnitude—namely, the extended base. Open-market operations, changes in required reserves attributable strictly to fiat changes in legal reserve ratios, and changes in the Federal Reserve's portfolio of discounts and advances, are reflected dollar for dollar in matching changes of the extended base. In particular, this crucial determinant of the money supply can be manipulated and completely controlled by the Federal Reserve authorities by means of the three policy instruments mentioned above.

The contribution of these three instruments to the observed behavior of the extended base varied considerably under different circumstances. A few illustrating cases may be selected to exemplify this point. During the recession of 1948-49, the Board lowered the legal reserve ratios in successive steps. This action was effectively designed to raise the extended base by a substantial amount, and was thus properly planned to increase the money supply and counteract the prevailing deflation. Unfortunately, the Federal Reserve authorities also engaged in large-scale open-market sales which lowered the extended base. These sales dominated the effect of the changes in the legal reserve ratios, a fact clearly revealed by the growth rate of the extended base. Contrary to the Federal Reserve's assertions, the open-market sales did not modify a prevailing "policy of ease"; neither did the Federal Reserve actually exert a "countercyclically stimulative" policy. Policy was deflationary at the time, because the positive effect of lower requirement ratios was overwhelmed by the negative effect of open-market sales.

A somewhat different constellation was observed in the recession of 1953-54. Once more, the release in required reserves, accomplished by the reductions in legal reserve ratios, contributed to raise the extended base. But, this effect was again offset by a contraction of Federal Reserve credit. This contraction was reflected simultaneously in the Federal Reserve's portfolio of discounts and advances, and its portfolio of Government securities. Thus, both discount policy

and open-market policy explain the deflationary direction in the movement of the extended base during the recession of 1953-54. Inspection of pertinent data for 1957-58 and 1960-61 would again reveal that both open-market and discount policy shaped the deflationary trend of the extended base for a good part of the recession.

Mr. BROCK. My time has expired.

Mr. BRUNNER. Do you wish me to elaborate further?

Mr. BROCK. I would like very much to follow through, but my time has expired.

The CHAIRMAN. Mr. Pepper?

Mr. PEPPER. I notice on page 3 of the statement of Dr. Brownlee the statement that "the Open Market Committee not only can be abolished, its functions can be abolished as well."

And Dr. Brownlee seems to be of the opinion that it is better to have a constant increase in the money supply rather than have it fluctuating as the Open Market Committee has done with it.

Is that correct?

Mr. BROWNLEE. Yes, that is correct.

Mr. PEPPER. Now, does Dr. Brunner differ from Dr. Brownlee in that matter?

Mr. BRUNNER. Not fundamentally, sir. However, I would reformulate the issue in the following manner. The development by the Federal Reserve authorities of a validated conception about the structure of the monetary process forms the most urgent and primary problem facing us. In this context, the choice between a rule laying down the target growth of the money supply or a framework of discretionary power appears to be of secondary importance. Whether we prefer a rule, or continue the exercise of discretionary powers, intelligent action must be based on relevant knowledge of the monetary process. In the absence of such knowledge, the Federal Reserve would have no reliable information how to achieve a given target growth of the money supply, neither possess any standards to appraise the soundness of its judgments evolving in the context of discretionary powers.

I wish to emphasize that I strongly agree with the stabilization of the growth rate of the money supply implicit in the proposal formulated by Professor Brownlee. Proposals 2 and 3, in the last section of my written statement, yield essentially a similar result. They provide that the growth rate of the base should be stabilized around a constant-trend line. Deviations from this trend should only occur to compensate the effect on the money supply of substantial variations in the public's allocation of money balances between currency and checking deposits.

Mr. PEPPER. May I ask both of you gentlemen if you will comment briefly on these two questions: One, assuming there is to be an agency that will have the power to enlarge and to contract the money supply of the country—now, one, should that agency be governed by some sort of rules or some sort of principles that are laid down by law, let us say; and, two, should that agency have a closer relationship to the Government, be more directly responsible to the Government than the Federal Reserve Board is at the present time?

Will each of you gentlemen comment briefly on those two questions, if you will.

Mr. BRUNNER. Yes, sir, I submit that it would be very useful to formulate some more specific goals guiding the monetary policy of the

Federal Reserve authorities. You will have noticed the gyrations of the growth rate of both money supply and extended base depicted on the appended graphs. It is difficult to see any rationale in these gyrations and simultaneously admit the relevant operation of monetary processes in our economy. Our analysis leads me to contend that such gyrations only contribute to amplify economic fluctuations. A more definite mandate addressed to the Federal Reserve authorities could in my judgment substantially improve the performance of our monetary system. The gyrations in the growth rate of the money supply were dominantly caused by unnecessary variations in the growth rate of the extended base. Removal of the variations in the latter magnitude can be accomplished by an appropriate mandate to our monetary authorities.

You covered also a second point in your question, bearing on the proper relation between an agency controlling the money supply and the Government. I feel that the so-called independence of the Federal Reserve System has been overemphasized on occasion. Monetary policy was subjected to serious political constraints in 1917-20 and also in 1941-47. The control of the money supply is an essential function of Government and should be explicitly faced as a responsibility of our Government. This obligation should be discharged in accordance with the particular function of the branch of government involved: Congress could formulate a more explicit mandate in order to eliminate the gyrations noted on chart II. Moreover, congressional hearings may develop a searching investigation of policy assessments typically made by the Federal Reserve authorities. Such investigations could effectively contribute to force the Federal Reserve authorities to base their judgments more on substantiated analysis and less on personal impressions. The administration, on the other hand, would discharge its peculiar function through appropriate choices of members for the Board.

Mr. PEPPER. Doctor, I am going to have to ask you if you will discontinue your reply, because my time is limited.

I must not trespass upon my colleagues. I think we get your general view. Thank you very much.

Now, Dr. Brownlee, would you comment briefly on those two questions, please, sir?

Mr. BROWNLEE. Well, yes. I think there should be more definite guidelines for the Federal Reserve or for whatever other agency would take over the control of the money supply. And a definite guideline such as increase the money supply this year by 3 percent is something everybody can see. We know whether or not we have 3 percent, 5 percent, or 1 percent.

With respect to the relationship of the monetary authority to the Government, certainly it should not be independent. That is, if Congress wants inflation, it ought to be able to get inflation, or if it wants deflation it should be able to get it. However, I don't think the Federal Reserve has been completely independent.

We talk about the independence of the Federal Reserve, but the administration has exerted a good deal of control over the Federal Reserve; that is, there are periods in which the monetary policy of the Federal Reserve was completely subordinated to the Treasury, and 1945 to 1951 is an example where the monetary policy was to stabilize

interest rates. When you have stable interest rates, you cannot choose any money supply that you want.

However, we are now faced with a situation where if the tax cut goes through we will be faced, I think, with a rather substantial deficit. This implies, in general, a tighter monetary policy than we should be pursuing if we were faced with a budget surplus or with a balanced budget.

It is in this sense that there certainly ought to be coordination between Treasury, or tax and expenditure policy, and monetary policy.

Mr. PEPPER. Thank you very much.

Mr. REUSS. Gentleman, I would like to ask you both a question. But before I do, I would like to clear up one minor item. Professor Brownlee, the second from the last sentence on page 6 of your paper says:

An easy money policy, if it is not to be inflationary, pushes private investment at the expense of consumption.

I wonder if you really mean that—an easy money policy would not push private investment at the expense of consumption in the case of a substantially underemployed economy.

Mr. BROWNLEE. You are correct—in that case. I am visualizing the following case: Let's imagine we wanted the gross national product this year to be \$630 billion. We can achieve the \$630 billion gross national product, we will say, with a 5-percent, long-term rate of interest and a budget deficit of \$20 billion.

We might also achieve it with a 3-percent rate of interest and a budget surplus of \$10 billion. Both these situations lead on a gross national product of \$630 billion, which is what we want.

The first, the high interest rate combined with the budget deficit, will result in more consumption and less investment than the second, a budget surplus combined with a low interest rate.

Mr. REUSS. The difference of policy between the two is that, in the second case, you tax very rigorously.

Mr. BROWNLEE. In a sense, we have a support price program for bonds.

Mr. REUSS. I think we have cleared up our difference. So for practical purposes of February 1964, a policy of relatively easy money would simply expand production, using the production gap that now goes to waste because we don't produce the goods and services that we could, rather than require a cutting down of consumption.

Mr. BROWNLEE. Well, that depends on what happens to the tax bill. If the tax bill goes through, I don't think we can pursue an easier money policy than we are pursuing at the present time without some increase in prices.

Mr. REUSS. An easier money policy, perhaps, but we can avoid going from our present policy to a tighter money policy.

Mr. BROWNLEE. Yes, I think that is right.

Mr. REUSS. Which brings me now to the point I wanted to ask both you gentlemen.

You both seem to be saying—and if that is what you are saying, I agree with you—that we would be better off if we increased our money supply year after year at something approximating the rate at which we would like to increase our gross national product.

In other words, instead of the niggardly increases in the money supply of 1 or 2 percent which we have had in the last decade, both of

you gentlemen would like to see increases in the money supply and in the gross national product on the order of 4 or 5 or 6 percent each year.

Does that do violent injustice to the position of either of you?

Mr. BROWNLEE. If we don't use these particular numbers—if we are not forced to use these particular numbers, 4, 5 or 6 percent—I think the answer is yes.

You are describing my position correctly.

Mr. REUSS. Well, what numbers would you use?

Mr. BROWNLEE. I don't know. I think 6 percent is probably a bit large.

Mr. REUSS. Four percent, however, is fair enough, is it not?

Mr. BROWNLEE. Four percent might be close. I might settle for something smaller.

Mr. REUSS. How small?

Mr. BROWNLEE. Maybe 3 percent.

Mr. REUSS. But not the 2 percent that we have been stumbling along with?

Mr. BROWNLEE. No, we don't have to settle for 2 percent.

However, I would like to qualify the statement which you have made as an interpretation of my position to take into consideration what is happening to the fiscal situation at the same time. That is, we ought to pursue in general a tighter monetary policy when we have a loose fiscal policy, and a looser monetary policy when we have a tight fiscal policy.

We cannot formulate monetary policy independently of our knowledge of fiscal policy.

Mr. REUSS. I recognize that. What I understand you to say, Professor Brownlee, is that you would not go for such a loose, sloppy, slatternly fiscal policy as would require a tightening of our money supply beyond a roughly 3 percent increase rate a year. Isn't that what you are saying?

Mr. BROWNLEE. I would hope that would be the situation. However, if we should by chance achieve a slatternly fiscal policy, then I would want to compensate as much as I could for this by the appropriate monetary policy.

Mr. REUSS. Well, do you think that it's good for the country to have a policy of fiscal slovenliness—cut taxes all the way and spend money like a drunken sailor, and then fix it all up by having tight money? You are not for that?

Mr. BROWNLEE. No, decidedly not.

Mr. REUSS. How about you, Professor Brunner?

Mr. BRUNNER. Thank you, sir. I would certainly agree with Professor Brownlee's concern to achieve a comparatively stable growth rate of the money supply. Monetary policy should be designed to maintain the growth rate of the base within a 3 percent to 4 percent band. Deviations from this band should only occur in response to unexpected variations of the public's partition of money balances between currency and checking deposits. Sustained periods with growth rates beyond the band indicated should be carefully avoided.

Moreover, variations in fiscal policy tend to exert a somewhat attenuated effect on the economy if monetary policy is effectively operating to stabilize the growth rate of the base in order to assure a stable growth rate of the money supply. Our investigations strongly sug-

gest that variations in fiscal policy, occurring in the context of a constant monetary policy, induce comparatively small responses in national income over the longer run. An increase in the deficit accompanied by a simultaneous increase of the base resulting from an accommodating Federal Reserve policy has a radically different effect from a deficit financed by borrowing from outside the Government sector. A stable growth rate of the base would imply that variations in the deficit can only change the rate of borrowing through issues on the open market. While variations in fiscal policy must reasonably be expected to affect the level of activity, the repercussions will remain relatively muted under the circumstances specified.

There is no doubt that we should carefully watch the trade off between monetary and fiscal policy. But I would also contend that a more intelligent arrangement of our monetary policy procedures yield some measure of leeway in our fiscal policy.

Mr. REUSS. Did either of you gentlemen see the recent statement by Chancellor Erhard of Germany? And did either of you, if you saw it, chuckle as I did, when you read that Chancellor Erhard was describing the proposed German economic policy for the year 1964, and after observing that Germany had full employment, no unemployment, and considerable inflationary pressures, concluded that it would therefore be necessary to restrain increases in the money supply.

The Chancellor then went on to say that he was quite caught up with the need for prudence, and that Germany should consequently restrain increases in the money supply for this year to 6 percent, so that they would be roughly equal with the anticipated 6 percent increase in the gross national product. Did either of you happen to see that?

Mr. BROWNLEE. I did not see the statement.

Mr. REUSS. Doesn't this suggest that if the prudent and cautious and fiscally admirable West Germans can talk about the kind of increase in their money supply in order to underwrite and validate a similar increase in their gross national product for 1964, a year in which they have full employment and inflationary dangers, that this country could well take a leaf from that book and make much greater additions to the money supply than we have made on the average in the last 10 years? If this were done, and were accompanied by sensible fiscal policies, there would be a much better chance that this country would enjoy a larger annual increase in its gross national product. Would either of you care to comment on that?

Mr. BRUNNER. A growth rate of 6 percent in the money supply is of course, mild when compared with some previous growth rates. I looked it up in the last days.

Mr. REUSS. It has been greater—10 percent?

Mr. BRUNNER. It was 6.8 percent from 1959 to 1960 and 14.3 percent from 1960 to 1961. The growth rates appear to be substantially smaller for 1962 and 1963.

Mr. REUSS. But doesn't it indicate that our money managers, with their niggardly penny ante 1- or 1-plus-percent increase in the money supply have to bear some part of the responsibility for the fact that we have lagged lamentably behind our West European friends and allies in economic growth in recent years.

Mr. BRUNNER. The comparatively restrictive policies pursued from 1955 until 1962 contributed—according to my judgment—substan-



tially to the retardation of our economic growth and to the rising levels of unemployment. Suitable monetary expansion could reasonably be expected to absorb some of the prevailing unemployment. On the other hand, any attempt to accelerate the money supply until unemployment has reached negligible levels would release serious inflationary pressures. But an admission of such limitations or constraints on the effective use of monetary policy does not remove a range of monetary expansion appropriately designed to lower unemployment without generating inflationary problems.

Mr. REUSS. Dr. Brownlee, you took what I thought was a refreshing view of the function of bankers, as people who are supposed to make loans to keep business moving.

Do you have some specific recommendations, other than that there be adequate increases in the money supply each year, for making our banking community somewhat more dynamic? One thing you seem to suggest is to take the interest ceilings off time deposits.

And did you also suggest that we permit the payment of interest on demand deposits?

Mr. BROWNLEE. Yes; I am decidedly in favor of removing ceilings on interest rates paid by banks.

If you mean, do I favor specific allocations of credit for specific sectors of the economy, my answer is "No," because I think we should use the interest rate as much as we can as a device for allocating credit.

I spent a considerable amount of time recently in South America, where I find that they do ration credit, and the outcome, I find, highly unsatisfactory.

In general, credit rationing is used to keep the dying sectors of the economy alive, and the live sectors of the economy from growing. I think we ought to avoid this as much as possible, as we have. May I make one comment with respect to comparisons of growth rates?

I think we look at the 6-percent figure in some Western European countries, an 8-percent figure in Japan, and 3 percent or less here, and we are inclined to say, "Well, why can't we achieve this 6- or 8-percent growth rate?"

First of all, I think there are quite a few large errors in these measurements, and we shouldn't take them seriously, particularly on a year-to-year basis. If we are going to look at comparative growth rates, they should be over a relatively long period of time, say 20 or 25 years, in which case our rates are probably not going to look as unfavorable as they have in the immediate postwar period. I think the rapid growth rates in Western Europe are partially accounted for by being able to put back into use with relatively little additional capital, capital which was unused before.

Let's take the case of a string of freight cars but no locomotive. We can make the whole thing operative by simply putting in a locomotive, giving a very high rate of return on investment.

This situation no longer exists in Western Europe. And our growth rates, I think, will compare more favorably with theirs in the future.

Mr. REUSS. Thank you.

Mr. Minish?

Mr. MINISH. No questions.

Mr. REUSS. Mr. Harvey?

Mr. HARVEY. No questions.

Mr. REUSS. Mr. Brock?

Mr. BROCK. Professor Brownlee, would you explain to me what you mean by money supply? What consists of the money supply, as you are referring to it in this discussion?

Mr. BROWNLEE. The total currency, plus demand deposits, if there are no restrictions on interest rates that can be paid by banks.

However, given our current restrictions, I would add in some portion of time and savings deposits.

But, generally, currency and demand deposits—the things against which we can write checks, or use to pay our bills at the A. & P.

Mr. BROCK. Now, you suggest that perhaps 3- to 4-percent increase in the money supply would be a figure which we might adopt as something of a goal, overall monetary policy goal; is that correct?

Mr. BROWNLEE. Yes.

Mr. BROCK. Would you explain to me how you intend to go about increasing this money supply?

Mr. BROWNLEE. I could do it by open market operations. This is my preferred procedure. That is in line with the Chairman's suggestion—or in line with the outcome which the Chairman wants to achieve.

At the same time, we are reducing the amount of the interest-bearing debt.

Mr. BROCK. You would do it by open market rather than other techniques?

Mr. BROWNLEE. Primarily open market operations.

Mr. BROCK. How would you handle the reserve requirements of banks if you were using open market operations?

Mr. BROWNLEE. How would I handle the reserve requirements?

Mr. BROCK. Would you have a completely stable reserve requirement?

Mr. BROWNLEE. Yes.

Mr. BROCK. And you would not fluctuate that?

Mr. BROWNLEE. No.

Mr. BROCK. Your rediscount rate would be the same?

Mr. BROWNLEE. The rediscount rate would be the same. Rediscounting is used primarily as a means of permitting banks to borrow temporarily to obtain reserves.

Mr. BROCK. Well, it does give some discouragement, and thereby affects the monetary supply.

Mr. BROWNLEE. Yes. But, again, if I understand correctly the way the Federal Reserve operates, it doesn't permit the banks to rediscount as much as they wish at the given rediscount rate, because at the rediscount window, banks in general are discouraged from rediscounting.

Mr. BROCK. But you would fix a rediscount rate permanently, would you?

Mr. BROWNLEE. Would I fix a rediscount rate permanently? I don't think I am really in a position to answer this question without giving it some additional thought.

Mr. BROCK. Well, let's look at it this way. You defined monetary supply in fairly restrictive terms, with which I would agree. But the volume of loans is certainly a part of the overall supply of money. It affects it.

Mr. BROWNLEE. Well, it shows up in demand deposits primarily.

Mr. BROCK. So either you are going to have a fixed rediscount rate, and use solely open market operations, or you are not, and you are going to counterbalance open market operations with a change in the rediscount rate.

Mr. BROWNLEE. Well, I think rediscounting is sufficiently small at the present time so we can more or less neglect it. I think you are asking me what kind of a role would I like rediscounting to play in the monetary system.

And I don't think I am able, at the present time, to give you a satisfactory answer, because I have not thought about it sufficiently.

Mr. BROCK. Given a consistent fiscal policy, would a monetary policy, envisioning a 4-percent expansion annually—would it fairly well insure a stable economy?

Mr. BROWNLEE. Well, we cannot be sure of a stable economy. But we probably get more stability this way than we do under existing procedures, whereby we try to guess what is going to happen in the future, miss frequently on such guesses, adopt anti-inflationary policies in anticipation of inflation, when deflation actually is the outcome, or adopt anti-deflationary policies in anticipation of deflation when inflation is the outcome. We cannot expect perfect stability. But it is my guess that we get more stability this way than with any other procedure that I can think of.

Mr. BROCK. All right. Let's take the problem we face with financing of the Federal debt. One of the bills we have before us—I have forgotten the number—provides for the amendment of the Federal Reserve Act to provide for Federal Reserve support of Government bonds when market yields equal or exceed  $4\frac{1}{4}$  percent. Would you be in favor of a bill of that type?

Mr. BROWNLEE. Would you repeat that?

Mr. BROCK. What, in effect, the bill does is put a limit on the cost of Government borrowing—it places a limit of  $4\frac{1}{4}$  percent.

Mr. BROWNLEE. I am opposed to this.

Mr. BROCK. May I ask Professor Brunner—are you in favor of this?

Mr. BRUNNER. No; I could not support this bill.

Mr. BROCK. All right. Professor Brownlee, going back to your statement, you were, as I understood it, actually in favor of monetizing the debt. You made some statement to that effect.

Mr. BROWNLEE. I am in favor of monetizing it as rapidly as we can, through such things as open-market operations; yes.

Mr. BROCK. How would you do it?

Mr. BROWNLEE. Well, I think the chairman has already described it for us. We are increasing the money supply annually, we say by 3 or 4 percent through open-market operations.

My guess is that this would involve purchases of Federal securities on the order of a billion and a half dollars per year at the present time. This is not a very rapid rate of monetization of the debt when we consider there is about \$150 billion of it to monetize.

Mr. BROCK. Well, in other words, it could take a hundred years.

Mr. BROWNLEE. That is correct.

Mr. BROCK. What would be the effect—let's say we have no increases, no deficit spending, should the day ever come—if we had no more deficit financing, and we are able to have strictly balanced budgets, no excess of income over expenses or vice versa, at the end of 150

years, and you have succeeded in monetizing the debt, what would be your monetary structure?

Mr. BROWNLEE. Then we can start buying private debt. Open-market operations can consist of buying private bonds in place of Government bonds.

Mr. BROCK. I see. And your controls would consist at that point then strictly dealing in private debt.

Mr. BROWNLEE. Yes, if there is no Government debt to buy. You might wish to buy foreign debt. But I prefer General Motors bonds to the bonds of Colombia or Bolivia.

Mr. BROCK. Well, in the meantime, say 20 years hence, what would be the situation if your Federal Reserve Open Market Committee had, say, \$40 billion in its portfolio? Then let's take a situation in which we had strong inflationary pressures on the economy.

Mr. BROWNLEE. Strong inflationary?

Mr. BROCK. Yes. What tools would they use to control the inflationary pressures?

Mr. BROWNLEE. Well—

Mr. BROCK. Would you ask that they try to have any effect on inflation by price control?

Mr. BROWNLEE. Will you repeat? Certainly they should be able to sell securities as well as purchase them.

However, I think situations in which security sales would be called for are relatively infrequent except in cases of large budget deficits.

Mr. BROCK. Should we get into a situation in which we may be approaching, in which the United States is losing its markets overseas, and have a balance-of-payments problem—now, are you going to, under your proposal—would you have the Federal Reserve take that into consideration in its monetary policy?

Mr. BROWNLEE. Well, I think it depends on the cause of this balance-of-payments deficit.

Mr. BROCK. Well, let's take the current situation.

Mr. BROWNLEE. Well, I think the current situation is one in which the dollar is priced too high.

The dollar is relatively overvalued, and we should have some devaluation in order to cure the exchange problem. We can't use monetary policy to do everything, and it is not appropriate to use monetary policy to try to cure the exchange situation. We ought to have a more flexible exchange rate.

Mr. BROCK. Then in relation to gold or in relation to what standard?

Mr. BROWNLEE. Well, the price of the dollar certainly is too high in comparison with the price of the mark. Perhaps it is too high in terms of the pound. These two are the principal Western European currencies.

Mr. BROCK. It would be difficult to change the price of the dollar unless we took it off the gold standard, would it not?

Mr. BROWNLEE. We are not on the gold standard at the present time. We are willing to sell gold to foreigners, but not to natives.

Mr. BROCK. I remember Professor Heller, when he was before the committee, suggested that if our situation continues to deteriorate, we might have the situation where we would have to go off the gold standard, or at least remove gold as a reserve requirement behind our cur-

rency within this country, and still maintain it for international payments. Is this a logical step?

Mr. BROWNLEE. I see no logic to maintaining our current gold requirements for currency, because we really make no use of them, except to sterilize a fairly good percentage of our total gold.

Mr. BROCK. But if we use it to pay our international obligations, and we guarantee a certain price relationship between the dollar and gold, then when you say a more flexible exchange rate, you are asking the other countries to make their currency more flexible in relation to ours.

You are not asking us to take the difficult step of making ours flexible, are you?

Mr. BROWNLEE. Yes, I am asking us to take the difficult step of making our currency more flexible.

The current price of \$35 per ounce is too low for gold.

Mr. BROCK. The Federal Reserve would have no concern over this balance-of-payments problem. Who should be concerned with fiscal policy, Treasury?

Mr. BROWNLEE. It should not be the concern of the monetary authority, Federal Reserve.

Mr. BROCK. If we were as a matter of fiscal policy to change the value of the dollar, would it not in effect have quite an effect on monetary policy?

Mr. BROWNLEE. If we were to change the value of the dollar?

Mr. BROCK. Yes.

Mr. BROWNLEE. Well, it will change the ratio of internal prices to foreign prices.

Mr. BROCK. It makes the dollar relatively more or less attractive, doesn't it?

Mr. BROWNLEE. Yes, but it won't change the internal price level in terms of dollars.

Mr. BROCK. But it could change the value of the dollar as related to international circles. In other words, there could be a great demand for the dollar overseas. Or we would have an outflux of dollars, or influx—depending upon the fiscal policy of the Federal Government, which is not related to the monetary policy.

Mr. BROWNLEE. Well, it depends upon the price we set for the dollar relative to other currencies.

Mr. BROCK. If we had a substantial change, you would have a substantial change in attitude toward the dollar?

Mr. BROWNLEE. Our goods would become more attractive in foreign markets, foreign goods would become less attractive in our markets, and our balance of payments would become more favorable.

Mr. BROCK. And the attitude toward the dollar would change?

Mr. BROWNLEE. Right. The attitude toward the dollar in foreign countries will change—but for purposes of acquiring U.S. goods.

Mr. BROCK. If there were a substantial change in the attitude toward the dollar, and let's say we had an influx of a tremendous amount of foreign currency, or foreign investments and so forth, if they like our rate of interest, for example, over here, it would have a definite effect upon the monetary supply in this country, would it not?

Mr. BROWNLEE. Well, it will have a definite effect certainly upon total purchases of goods and services in the country.

Mr. BROCK. Which is related to money supply?

Mr. BROWNLEE. Well, it is true this is related to the money supply.

But the causal relationship runs the other way; that is, the money supply effects primarily total purchases rather than the other way around.

Mr. BROCK. What I am getting at, and what seems to be a little inconsistent to me about your theory—and I am not disagreeing, but I am just trying to find out—it seems to me we might be trying to operate in a vacuum, if we try to disassociate monetary policy from fiscal policy. There has to be a causal relationship. And if we get into a situation as you have just described, where there is a change in the value of the dollar, and its appeal to other people, and we have a built-in increase of 4 percent in this country, if we had at the same time that that occurred strong inflationary tendencies in this country, and if we had a strong influx from oversea currencies, we could have a very difficult economic situation, because of inflation.

Mr. BROWNLEE. May I try to rephrase the situation as I think you put it?

Imagine there is a strong increase in demand on the part of foreigners for U.S. goods. This is an inflationary disturbance, so to speak.

Should we not offset this by appropriate monetary change? Is that your question?

Mr. BROCK. I am just asking, isn't there a cause and effect relationship which they should take into consideration?

Mr. BROWNLEE. Well, I think it depends on whether or not this is a permanent change in the demand on the part of foreigners or a temporary change. If it were a permanent change, then certainly we should and could take it into account. If it is a temporary change, I would be willing to ignore it; that is, this kind of thing one year is offset by the opposite kind of thing the next.

Mr. BROCK. Thank you very much.

The CHAIRMAN. Mr. Hanna?

Mr. HANNA. Thank you, Mr. Chairman.

I would like to welcome Professor Brunner here as a graduate from UCLA. I am delighted to see my alma mater being represented in these hearings.

I should like to ask both of the gentlemen this question.

Is it not true that neither the Federal Reserve System nor any of the administrative agencies of the Government who have a responsibility in terms of, say, things like wages, prices, or employment, or growth, can really operate isolated one from the other. In other words, do not these things have some interrelationship. Do not these things interrelate?

Mr. BRUNNER. Your question raises an issue which occurs implicitly in statements frequently made by spokesmen of the Federal Reserve System. Distinct agencies of the Government are seen to be responsible for different aspects of our economy. One agency is concerned with monetary policy and monetary phenomena, another agency deals with employment policy, a third one with price-wage policy, et cetera. In this manner a combination of policies are offered in separate compartments. Association of such diverse policy responsibilities with different agencies unavoidably raises a quest for coordination of the separated and apparently independent policies.

This conception, frequently encountered, requires a careful clarification. Foremost, monetary policy affects via the monetary processes the pace of economic activity and the behavior of the price level. Monetary policy is thus not directed at a monetary aspect of the economy, requiring complementation with an employment policy and price-wage policy. Monetary policy generates impulses which are transmitted to the behavior of employment, prices, and wages. It is, therefore, of crucial importance that monetary policy be framed in a context which acknowledges this effect of monetary processes on the economy. To this extent we require not an interrelation of diverse policies, but an explicit recognition that monetary policy has systematic consequences on the volume of unemployment and the behavior of prices and wages.

But there remains another aspect to your question which does bear on coordinated policies of different agencies. Changes in demand and production conditions continuously generate a reallocation of our human and nonhuman resources. Unemployed resources are an unavoidable byproduct of this reallocation process. The volume of these unemployed resources depends on the reallocation pressures generated by changing demand and supply conditions on the one side and the absorptive capacity of the market process on the other. This kind of unemployment is not insensitive to monetary expansion. But a substantial absorption of such unemployment would very likely require a rate of inflation we prefer to avoid. Other policies supply probably more efficacious instruments to induce an appropriate absorption of reallocative unemployment. Such policies would operate to improve the absorptive capacity of the market process. A variety of institutional arrangements involving retraining, social mobility, information distribution, and so forth, could still be introduced to improve our labor markets. Lastly, a sharp vigil against practices involving restraint of trade would also raise the absorptive capacity of the market process. I conclude thus that employment policy and price-wage policy may be properly listed as separate or independent prongs of our general economic policy, provided they are specifically concerned with the quality of the markets' absorptive capacity. To this extent coordination or interrelation of policies meaningfully exists.

Mr. HANNA. Well, I would take it, then, you would say there is a greater effect flowing from monetary policy into some of these other fields than there is flowing back the other way. But they are not without some effect in the other flow.

Mr. BRUNNER. Our investigations indicate a strongly marked asymmetry. Monetary processes exert a substantially stronger influence on economic activity and prices than the later magnitude exert on the monetary processes. I wish to emphasize this asymmetry because I wonder on occasion whether the Federal Reserve authorities fully recognize the effect exerted by monetary policy on levels of unemployment and the price level. In particular, I wish to assure myself that we do explicitly recognize that monetary policy reaches beyond monetary phenomena and the credit markets.

On the other hand, it should also be acknowledged that monetary policy yields no cure for all problems. Other kinds of policies have to supplement monetary policy. Such policies can effectively improve

the efficiency of the market process and lower unemployment barely responsive to monetary policy without substantial inflation.

Mr. HANNA. Well, then, I think that from what you said I might very well feel assured that to the degree that monetary policy is treated as though it were looking down a tube at our economy, as though it had had a totality all of its own, independent of anything else, that would be incorrect—if we looked—if we have set our monetary policy with the idea that we didn't have to be too much concerned in these other fields, that it would be a mistake. And it would seem to me that if you set one goal in terms of wages and another goal in terms of employment, and then these found themselves up against a conflict with monetary policy, you might be canceling out in some degrees policies that are made by the same government, because they didn't include their own interrelationships.

Couldn't we possibly have a monetary policy that would be exactly contrary to some other policies within these other areas?

Mr. BRUNNER. Such possibilities could certainly arise. I remember a classic case within the realm of monetary-fiscal policy which occurred in Switzerland during the early postwar years. The Central Bank was engaged in an anti-inflationary policy, while the treasury, social security administration, and postal checking system proceeded on a line which tended to offset the Central Bank's policy. But this very possibility of conflict once more induces me to stress the urgency of a carefully assessed and explicit conception concerning the nature of the processes operated upon. Without a validated knowledge about these processes and a relevant interpretation of the different policy actions, it would be impossible to coordinate intelligently the various policies.

Mr. HANNA. I think we had a witness yesterday who suggested that perhaps we need to coordinate in this field similarly as we have done in the military field, in a sense of bringing together under one command these people who necessarily must have policies and move out into the same field of action. Would you feel that this might be a productive move?

Mr. BRUNNER. May I clarify your question, sir? Are you saying that we should combine under one command, for instance, fiscal policy and monetary policy?

Mr. HANNA. Well, there was suggested that there would be under one, if you want to call it command—I think the analogy was made to the military—that at least the policies be clarified through the Executive, since he would be the one person responsible for the state of the economy on all of its fronts, and that there ought to be some kind of central coordination, so that the movement of the economy would have some total relationship, and that we would all be fighting in the same war—they would not find themselves fighting each other.

Mr. BRUNNER. Coordination of policy does not require a single agency concerned with the whole spectrum of economic policy. Such coordination can be usefully achieved by means of a general frame laid out by Congress. This frame may appear in form of a more explicit mandate addressed to the Federal Reserve authorities. This mandate should be specific enough to prohibit the gyrations observed in the growth rate of the money supply, and to maintain this growth rate within a limited range—say, 3 to 4 percent. If this monetary policy were clearly understood, other agencies would possess clear and



reliable expectations concerning the trends in monetary policy, and proceed accordingly to discharge their own policy function.

Coordination of policy in the context under discussion is not so much an organizational-institutional problem as a problem of reliable information based on relevant knowledge. This information and knowledge could be most satisfactorily induced with the aid of suitably explicit frameworks, or guidelines, formulated by Congress. I would contend that coordination of policy achieved in this manner can be expected to work adequately enough. I see no advantage in a single administrative agency covering the whole of economic policy. On the contrary, serious problems are likely to arise under such a concentration of administrative functions.

Mr. HANNA. You think we could do this and still have the flexibility that we need to adjust to the changes?

Mr. BRUNNER. I beg your pardon?

Mr. HANNA. Do you think we could maintain a flexible posture, and still carry out such coordination?

Mr. BRUNNER. Yes, I think so.

Mr. HANNA. That is all, Mr. Chairman.

The CHAIRMAN. Mr. Harvey?

Mr. HARVEY. I have no questions, Mr. Chairman.

Mr. BROCK. I would like to follow up one point.

The CHAIRMAN. You may proceed, sir.

Mr. BROCK. Professor Brunner, in Mr. Hanna's question—I think what you were seeking is that, if we got into a period of, say, economic distress, would we by this approach limit the ability of the monetary policy to respond to need by pumping more money into the economy?

Mr. HANNA. That was in my question about would we impair the flexibility. In other words, I am sure if anybody suggested such an idea that the most obvious defense would be that you would lose this flexibility.

Now, I am not convinced that you would. That is why I would like to have these experts' testimony whether you would or not. If we would, this would be certainly a very strong defense.

Mr. BROCK. Well, I would like either one of you to answer what would be the response of either our fiscal or monetary policy if a situation of deflation and depression were to occur. Are we still under the philosophy that we use pump priming, for example? Would we, rather than increase the money supply, substitute Federal spending for that increase in the money supply? What tools would be used to slow down a recession?

Mr. BROWNLEE. I think that it depends on what caused the recession. Many of the fluctuations that have taken place, particularly in the postwar period, are the responsibility of the Government. If, for example, the recessions were brought about by declines in Federal spending without declines in taxes, or if we maintained the current or proposed tax schedule with no increases in Federal spending over the next few years, then, of course, while this could be compensated for by monetary policy—we are really not tackling the cause when we use monetary policy to try to solve this particular problem.

We were talking about this kind of case when Mr. Reuss was in the chair. We were postulating essentially a sane-type fiscal policy, in which case I think we don't need this overall military-type organization.

To comment on Mr. Hanna's question, I don't think any one person, or any one agency, ought to be responsible for the state of the economy. I don't think we ought to have a wage policy other than we ought to have wages flexible enough so that labor can shift from one sector of the economy to the other.

And the monetary authorities should not have an employment goal, but a gross-national-product goal, in money terms; and this should be translated into a quantity-of-money goal, nothing more. In this sense, the overall military-type organization, I don't think, is really appropriate.

Mr. BROCK. Well, in your proposal of having a fixed rate of increase, somewhere between 3 and 4 percent increase in the monetary supply, you are eliminating monetary policy as a factor in determining the actions we take in a recession or inflation.

Mr. BROWNLEE. Well, I would consider this 3 or 4 percent something like the Constitution. Obviously, it is something that could be amended. First of all, we don't know whether it should be 3, 4, or 5 percent. We will have to do some experimenting to know what goes on.

Secondly, if a situation should come up, where it was obviously appropriate to have a larger or smaller increase, we ought to make it.

Mr. BROCK. Well, let me ask you this: In a recession, obviously—or at least it is obvious to me—but obviously, to me, the demand for loans, the demand for money, decreases in a recession.

Mr. BROWNLEE. Sometimes a recession can be caused by an increase in the demand for money.

Mr. BROCK. "Which came first, the hen or the egg?" is not the point. The point is that during a recession you have a lessening of demand for money. Is this a fair statement?

Mr. BROWNLEE. Well, insofar as income falls, and the demand for money depends upon income, the answer is correct.

Mr. BRUNNER. May I ask a clarifying question, sir? You were referring simultaneously to the demand for money and the demand for loans. It is very important to distinguish sharply these two demand patterns. The demand for money summarizes the response of the public's money balances to changes in market conditions, and the public's wealth position, and the demand for loans describes the response of the public's indebtedness—or rate of indebtedness—to banks to changes the same magnitudes. They play a radically different role in our economy's monetary process.

Mr. BROCK. You are entirely correct. I meant the demand for loans, because—

Mr. BRUNNER. I thought so. Thank you.

Mr. BROCK. The velocity of money also would fall, would it not?

Mr. BRUNNER. Yes.

Mr. BROCK. Isn't this a prime factor in the money supply in the country?

Mr. BRUNNER. No, sir. Velocity has no direct effect on the money supply. Both have one determinant in common—namely, the prevailing interest rates. But this common determinant plays a very asymmetric role. Interest rates decisively shape the behavior of velocity. Some other factors also contribute systematically to affect velocity behavior. Money supply, on the other hand, is only marginally influenced by interest rates. The money supply is dominated by the

extended base, a magnitude emerging from the policy actions of the Federal Reserve authorities.

Mr. BROCK. Well, in the depression days, was the velocity of money high?

Mr. BRUNNER. No, sir. Velocity moves with the cycle. Moreover, the data reveal that the cyclic changes of velocity exhibit, in the average, an order of magnitude similar to the cyclic changes in the money supply.

Mr. BROCK. Well, in other words, in good times your velocity increases.

Mr. BRUNNER. That is right.

Mr. BROCK. In bad times, it decreases.

Mr. BRUNNER. That is right.

Mr. BROCK. So, if you had a stable rate of influx of money—increase in the monetary supply—it would have no positive effect, really, in a depression, because the demand for loans would be nonexistent, the psychology of the Nation would be poor, and the economy would be falling.

Mr. BRUNNER. No, that is not correct, sir.

Mr. BROCK. Well, you just said that it was true—

Mr. BRUNNER. No, sir. There is no doubt about the cyclic behavior of changes in velocity and the money supply, and in particular, also of velocity itself. The evidence is clear on this point. But nothing whatever can be inferred from this observation with respect to the effectiveness of monetary policy. As a matter of fact, these observations are consistent with our hypotheses explaining the behavior of velocity and the money supply, hypotheses implying the continued effectiveness of monetary policy.

Our detailed investigations covering both interwar and postwar periods strongly suggest that the deflationary phase of the thirties did not render monetary policy impotent. In particular, the demand for loans remained sensitive to variations in interest rates.

Monetary policy was not powerless, it was simply not used. The tremendous expansion of the money supply, initiated in 1933, was perhaps the single most important factor contributing to the recovery. It is noteworthy, however, that this expansion was not due to policy actions but resulted from the inflow of gold. Monetary policy contributed nothing to the upswing, but was very likely a major cause of its termination in 1937.

Mr. BROCK. Let me pursue that from a different tack. In the depression days, what if you had a fixed input of money, and as Professor Brownlee has suggested, we used the Open Market Committee—

Mr. BROWNLEE. Open market operations.

Mr. BROCK. Yes, the operations of the Open Market Committee. If there isn't a demand for loans, Professor Brownlee, what effect would it have, if you had an expansionary policy?

Mr. BROWNLEE. If there isn't a demand for loans?

Mr. BROCK. Yes.

Mr. BROWNLEE. Let's go back to your first question. You asked essentially should we use, or should we try to use, monetary policy to offset depressions, or inflation. My answer is "No"—I want to stick to this 3- to 4-percent rate of increase in the money supply, although if there were some really disastrous disturbance of an inflationary or deflationary nature, I would alter this.

In general, if there is a reduction in the demand for loans, this shows up in a reduction in interest rates, and some larger quantity of loans at this lower rate of interest than would have been taken out at higher interest rates. That is, the interest rates adjust the demand and supply for loans. And I would expect relatively small fluctuations in this under the kind of policy which I am proposing.

In answer to your question, obviously you cannot force people to take loans if they don't want to borrow money. But you can induce them to take loans—borrow money—to make purchases at lower rates of interest.

Mr. BROCK. Logically, those that have money would be competing to put it to work, and they would cut their rates of interest in order to attract more borrowers.

Mr. BROWNLEE. Yes.

Mr. BROCK. But if we are going to eliminate—you almost are eliminating monetary policy as a factor—

Mr. BROWNLEE. I am proposing that we eliminate discretion in monetary policy.

Mr. BROCK. That is right. So you would not change your policy to take into account one year, a change in the economic situation.

Mr. BROWNLEE. That is right.

Mr. BROCK. Would you tell me what policy you would use?

Mr. BROWNLEE. First of all, I would not expect drastic year-to-year changes. But in the event we did have a large inflationary shock, I might follow on a tighter monetary policy. However, I would not change my policy, noting that the cost of living index had gone up, say, one-tenth of a point or gone down one-tenth of a point, or perhaps even 1 point.

Mr. BROCK. Well, you are not going to use monetary policy over the short range, then you are going to use fiscal policy.

What fiscal policy would you suggest? A sliding tax rate?

Mr. BROWNLEE. No. Essentially having the tax system such that the budget would balance at the gross national product which is desired. That is, if we want a \$630 billion gross national product, we want the tax system set up so that budget would approximately balance at \$630 billion gross national product.

Mr. BROCK. All right.

If we set out these goals—of course, the function of this committee is to try to determine what procedures are necessary—if we were to set certain basic goals for monetary policy, should we define them by law at a fixed percentage, give them a range from 3 to 4, or should we say that the goal of monetary policy is to provide a fairly consistent rate of increase in the money supply?

Mr. BROWNLEE. I think I would start with the latter. But if I found that the monetary authorities were not following this, then I might legislate a number, such as 3 or 4 percent.

The CHAIRMAN. Mr. Brock, may I interrupt just a minute, please?

Our bill comes up first thing, at 12 o'clock, and we have been notified. If it is all right with you gentlemen, we will ask you in writing any additional questions after you look over your transcript. Will that be all right?

Mr. BROCK. Yes, sir.

The CHAIRMAN. Thank you very much. We will recess until 10 o'clock in the morning. Thank you, gentlemen, very much.

(Whereupon, at 11:50 a.m., the committee recessed, to reconvene at 10 a.m., Thursday, February 27, 1964.)

# THE FEDERAL RESERVE SYSTEM AFTER 50 YEARS

THURSDAY, FEBRUARY 27, 1964

HOUSE OF REPRESENTATIVES,  
SUBCOMMITTEE ON DOMESTIC FINANCE OF THE  
COMMITTEE ON BANKING AND CURRENCY,  
*Washington, D.C.*

The subcommittee met, pursuant to recess, at 10 a.m., in room 1301, Longworth House Office Building, Hon. Wright Patman (chairman) presiding.

Present: Representatives Patman, Reuss, Hanna, and Widnall.

The CHAIRMAN. The committee will please come to order.

At this point I would like to put in the record the statement I mentioned yesterday comparing the salaries of high-ranking Government officials and the salaries of other Government officials working for the Federal Reserve, commencing with the President of the United States, \$100,000. Next is the President of the Federal Reserve Bank of New York, \$70,000, and then the President of the Federal Reserve Bank of Chicago, \$55,000. It gives several pages of the higher salaries in Government. It will be placed in the record at this point.

(The statement referred to follows:)

## WIDE VARIANCES IN TOP SALARIES RECEIVED BY FEDERAL RESERVE BANK EMPLOYEES AND THOSE OF OTHER U.S. GOVERNMENT EMPLOYEES

In our system of government, why do we have an appropriations process? Why do we have authorization hearings, authorization bills, appropriation hearings, appropriation bills, and all the rest of it?

Is it because we do not trust the specific individuals who are put in charge of the agencies in question? Of course not. Is it because the Congress sees fit to interfere with the petty, day-to-day matters that occupy so much of the energy of the agencies and departments? Of course it is not.

We have the appropriations process, with all its cumbersome machinery and sometimes irritating delays, because it safeguards the fundamental right of the people to be governed by their elected representatives.

What happens when an independent agency like the Federal Reserve System gets away from the tried and true American system of checks and balances and proper auditing is pointed up by the list of top salaries of our principal Government officials, including Federal Reserve topkicks.

The inequities are so glaring that I am certain the Congress will want to do something about them. When the American people learn

about these absurd inequities, I am certain that they will insist that the Congress do something about them.

Our staff made a comparative analysis of the highest paid officials on the public payroll of the United States and the Federal Reserve banking system. Just as Government officials are paid by the American taxpayer, so, too, are the officials of the Federal Reserve System. It is interesting to see how many of these high-bracket individuals come from the Federal Reserve banks. It is convincing evidence that the officials of the Federal Reserve System are rather generous in setting salaries for themselves, because, as I have indicated, the ordinary checks and balances do not affect the Federal Reserve people and they do not submit to an audit by the General Accounting Office, as do other Government and semigovernmental agencies.

Let us look at some of these absurd inequities. It will come as a shock to most Americans that the second highest paid salary paid for by the taxpayers, the one right next to the President, goes to the President of the New York Federal Reserve Bank. How absurd that he receives twice as much as the Chief Justice of the United States; twice as much as the Speaker of the House of Representatives; how utterly ridiculous that he receives twice as much as the Vice President of the United States.

How absurd that the Presidents of the Federal Reserve Banks of Atlanta, Cleveland, and Richmond get \$40,000—\$15,000 more than the Secretary of State of the United States, and \$15,000 more than the Secretary of the Treasury of the United States.

The appropriations process is one of the basic and most important tools for the protection of the principles of our American system.

Now, you don't have to have appropriations, because there is an alternative. You can have back-door financing instead, where an agency gets its money through the "back door," as it were, and spends the money without accounting to anyone, and without an independent audit by any other Government agency.

But where is the protection in that? Where is the Congress control over public policy? Where is the people's control over how and where their tax dollars are spent?

It is just like in the old days, when a farmer sent his sons to town for feed and supplies, and he would toss them his purse full of money, without counting it, and he would tell them what to go and buy. And they would go and buy it, and come back, and they would toss the purse back to their father, and he would put it in his pocket without opening it and without counting it to see what was inside and what they had spent.

He was entirely at their mercy, and if they were honest, all right, and if they were not, he had no way of knowing and no protection. And he had no way of knowing how they spent the money, even if they were honest and didn't steal, he had no way of knowing whether they spent it wisely, and paid the lowest price for what they got, and didn't waste it.

Now, that is precisely how the Federal Reserve System, which spent about \$200 million of the people's money last year, that is how the Federal Reserve operates.

How does the Fed get its money? Do they come up here for authorizations and appropriations? They do not. Ninety-nine percent of the Federal Reserve's income last year came from the interest on

their portfolio of Government securities, and that interest, of course, is paid by the taxpayers of the United States. It is Government money and the people's money.

And they take that money—about a billion dollars a year—and they spend what they want, how they want it—last year they spent about \$200 million—and then they turn the rest back to their father. And in 50 years they have never had an independent audit of any kind.

Now, that is back-door financing at its very worst—no appropriations hearings, no safeguards, no congressional control over public policy decisions, no control by the people over how their money is spent, no safeguards against theft, no safeguards against waste.

During the hearings we are holding on the Federal Reserve, witnesses from the Fed have repeatedly made statements that they were insulted that anyone was impugning their individual honesty and competence by suggesting they should have an audit, or come under the appropriations process.

That line of argument misses the point entirely. I am not, never have, and I hope, never will accuse these men individually or collectively of dishonesty and incompetence. No one is making such a charge. The point is that ours is a government of laws not men and we built in safeguards like the appropriations process so that no matter what kind of men run the system, there are still safeguards against misuse of funds and misuse of authority.

If you give a man the authority to make some vital decision like determining the interest rate that will be charged on any loan or debt in the United States, including the public debt, it isn't enough to say, "Well, that's an honest man, I know him, he's a good man and he would never steal a dime." It isn't enough. You've got to say, "Well, I know it's all right, because every year he has to come before the Congress and justify his salary and his expenses to the appropriations committees, and he only spends what they allow him to spend, so we have those safeguards over how he behaves."

So I think this is very bad business, and I think that we should all look very carefully at how the Fed spends its money, which they get from the taxpayers without appropriations from anybody.

*Annual salaries of the principal Federal officials including the highest paid officials of the Federal Reserve System, January 5, 1964*

President of the United States.....	\$100,000
President, Federal Reserve Bank, New York.....	70,000
President, Federal Reserve Bank, Chicago.....	55,000
President, Federal Reserve Bank, Philadelphia.....	40,000
President, Federal Reserve Bank, Cleveland.....	40,000
President, Federal Reserve Bank, Richmond.....	40,000
President, Federal Reserve Bank, Atlanta.....	40,000
President, Federal Reserve Bank, Minneapolis.....	40,000
President, Federal Reserve Bank, Dallas.....	40,000
President, Federal Reserve Bank, San Francisco.....	40,000
First Vice President, Federal Reserve Bank, New York.....	40,000
President, Federal Reserve Bank, Kansas City.....	37,500
Vice President and Senior Adviser, Federal Reserve Bank, New York.....	37,500
Chief Justice of the United States.....	35,500
President, Federal Reserve Bank, Boston.....	35,000
President, Federal Reserve Bank, St. Louis.....	35,000
Vice President, Federal Reserve Bank, New York.....	35,000
Vice President of the United States.....	35,000



*Annual salaries of the principal Federal officials including the highest paid officials of the Federal Reserve System, January 5, 1964—Continued*

President of the Senate pro tempore, when there is no Vice President of the United States.....	\$35, 000
Speaker of the House of Representatives.....	35, 000
Associate Justices of the Supreme Court.....	35, 000
Vice President, Federal Reserve Bank, New York.....	32, 500
Vice President, Federal Reserve Bank, New York.....	31, 500
First Vice President, Federal Reserve Bank, Kansas City.....	30, 000
Vice President, Federal Reserve Bank, New York.....	29, 000
Vice President and General Counsel, Federal Reserve Bank, New York.....	28, 500
Vice President, Federal Reserve Bank, New York.....	28, 000
Adviser to the Board, Board of Governors of the Federal Reserve System.....	27, 500
First Vice Presidents, Federal Reserve Banks of Boston, Philadelphia, Richmond, Chicago, St. Louis, and San Francisco.....	27, 500
First Vice President and General Counsel, Federal Reserve Bank, Atlanta.....	27, 500
Vice Presidents (2), Federal Reserve Bank, New York.....	27, 500
U.S. Representative to the United Nations and Representative in the Security Council.....	27, 500
U.S. Permanent Representative to the North Atlantic Treaty Organization.....	27, 500
Ambassador at Large.....	27, 500
Chiefs of Mission, class 1, Foreign Service.....	27, 500
Vice President, Federal Reserve Bank, San Francisco.....	26, 500
Adviser to the Board, Board of Governors of the Federal Reserve System.....	26, 000
Secretary of the Board, Board of Governors of the Federal Reserve System.....	26, 000
General Counsel, Board of Governors of the Federal Reserve System.....	26, 000
Vice President, Federal Reserve Bank, New York.....	26, 000
Assistant Vice President, Federal Reserve Bank, New York.....	25, 500
Circuit judges, U.S. courts of appeals.....	25, 500
Chief Judge and Associate Judges, U.S. Court of Claims.....	25, 500
Chief Judge and Associate Judges, U.S. Court of Customs and Patent Appeals.....	25, 500
Judges, U.S. Court of Military Appeals.....	25, 500
Director, Division of Research and Statistics, Board of Governors of the Federal Reserve System.....	25, 000
Director, Division of Examinations, Board of Governors of the Federal Reserve System.....	25, 000
First Vice Presidents, Federal Reserve Banks of Cleveland, Minneapolis, and Dallas.....	25, 000
Vice President and Senior Adviser, Federal Reserve Bank, Richmond.....	25, 000
Vice President and Cashier, Federal Reserve Bank, Philadelphia.....	25, 000
Assistant General Counsel, Federal Reserve Bank, New York.....	25, 000
Secretary of State.....	25, 000
Secretary of the Treasury.....	25, 000
Secretary of Defense.....	25, 000
Attorney General.....	25, 000
Postmaster General.....	25, 000
Secretary of the Interior.....	25, 000
Secretary of Agriculture.....	25, 000
Secretary of Commerce.....	25, 000
Secretary of Labor.....	25, 000
Secretary of Health, Education, and Welfare.....	25, 000
Deputy U.S. Representative to the United Nations and Deputy Representative in the Security Council.....	25, 000
Deputy U.S. Representative in the Security Council, United Nations.....	25, 000
Chiefs of Missions, class 2, Foreign Service.....	25, 000
U.S. Representative to the Organization for Economic Cooperation and Development.....	25, 000
U.S. Representative, European Communities.....	25, 000
U.S. Representative on the Council of the Organization of American States.....	25, 000
Special Representative for Trade Negotiations.....	25, 000

*Annual salaries of the principal Federal officials including the highest paid officials of the Federal Reserve System, January 5, 1964—Continued*

Director, Office of Emergency Planning.....	\$25, 000
Associate Directors (2), Division of Research and Statistics, Board of Governors of the Federal Reserve System.....	24, 500
Senior Vice President, Economic Research, Federal Reserve Bank, Kansas City.....	24, 500
Vice President, Federal Reserve Bank, Dallas.....	24, 500
Assistant Vice President, Federal Reserve Bank, New York.....	24, 250
Adviser, International Finance, Board of Governors of the Federal Reserve System.....	24, 000
Director, Division of Bank Operations, Board of Governors of the Federal Reserve System.....	24, 000
Vice President, General Counsel, and Secretary, Federal Reserve Bank, Chicago.....	24, 000
Vice Presidents, Federal Reserve Banks of New York and Chicago.....	24, 000
Assistant to the Board, Board of Governors of the Federal Reserve System.....	23, 500
Adviser, Research and Statistics, Board of Governors of the Federal Reserve System.....	23, 500
Assistant General Counsel, Board of Governors of the Federal Reserve System.....	23, 000
Vice President and Secretary, Federal Reserve Bank, St. Louis.....	23, 000
Vice President and Cashier, Federal Reserve Bank, Chicago.....	23, 000
Vice Presidents, Federal Reserve Banks of Cleveland (2) and Chicago.....	23, 000
General Auditor, Federal Reserve Bank, Chicago.....	23, 000
Medical Director, Federal Reserve Bank, New York.....	23, 000
Economic Advisor, Federal Reserve Bank, New York.....	23, 000
Chief Judge of the U.S. District Court for the District of Columbia.....	23, 000
Legislative Counsel, Board of Governors of the Federal Reserve System.....	22, 500
Vice President and Secretary, Federal Reserve Bank, Minneapolis.....	22, 500
Vice President and Secretary, Federal Reserve Bank, Dallas.....	22, 500
Vice Presidents, Federal Reserve Banks of Cleveland and St. Louis.....	22, 500
District judges, U.S. district courts.....	22, 500
Judges, Tax Court of the United States.....	22, 500
Judges, U.S. Customs Court.....	22, 500
Director of the Bureau of the Budget.....	22, 500
Comptroller General of the United States.....	22, 500
Under Secretary of State.....	22, 500
Deputy Secretary of Defense.....	22, 500
U.S. Representative in the Economic and Social Council, United Nations.....	22, 500
U.S. Representative in the Trusteeship Council, United Nations.....	22, 500
Chiefs of Missions, class 3, Foreign Service.....	22, 500
Director, Office of Science and Technology.....	22, 500
Deputy Special Representative for Trade Negotiations.....	22, 500
Administrator, Agency for International Development.....	22, 500
Chairman, Atomic Energy Commission.....	22, 500
Administrator, Federal Aviation Agency.....	22, 500
Administrator, National Aeronautics and Space Administration.....	22, 500
Director, U.S. Arms Control and Disarmament Agency.....	22, 500
Members of Congress.....	22, 500
Postmaster, San Francisco.....	18, 500
Postmaster, Dallas.....	18, 465
Postmaster, Minneapolis.....	18, 465
Postmaster, New York.....	18, 250
Postmaster, Chicago.....	17, 750
Postmaster, Philadelphia.....	17, 500
Postmaster, Cleveland.....	17, 000
Postmaster, Boston.....	17, 500
Postmaster, St. Louis.....	17, 500
Postmaster, Kansas City.....	15, 990
Postmaster, Atlanta.....	15, 000
Postmaster, Richmond.....	14, 075

In looking over the listing of salaries, bear in mind that those of officers and employees of the Federal Reserve banks are fixed by their respective boards of directors, subject to the approval of the Board of Governors of the Federal Reserve System. Salaries of members of the Board's staff are fixed by the Board. All other salaries listed are fixed by law. This includes the Governors.

The CHAIRMAN. Today, we are going to hear from two more outstanding economists, Prof. Eli Shapiro, of the Graduate School of Business of Harvard University; and Prof. Paul A. Samuelson, of MIT.

Professor Shapiro was a Deputy Director of Research for the Commission on Money and Credit.

Professor Samuelson is the author of the most widely read text on economics and many other works. I am sure we will benefit greatly from today's testimony.

Professor Samuelson, I notice you have a prepared statement and Professor Shapiro, too. They have been submitted to the committee and we have passed them out.

This committee is divided up into eight subcommittees and three of those subcommittees are meeting today, which takes some of our people away, but they are following this testimony rather closely.

We get the benefit of it the next morning. This morning we received yesterday's testimony and tomorrow morning we will receive today's testimony.

The members are very much interested in this and they are giving it careful consideration.

We appreciate your coming down, gentlemen. We appreciate hearing from you and, Professor Shapiro, you may start first. If you would like to just put your statement in the record at the point where you commence, and not read it unless you desire to do so, but emphasize the points that you would like to emphasize, please do so.

Professor Shapiro.

**STATEMENT OF PROF. ELI SHAPIRO, HARVARD UNIVERSITY,  
CAMBRIDGE, MASS.**

Mr. SHAPIRO. Thank you very much, Mr. Chairman.

The CHAIRMAN. All right, Professor Shapiro, you may proceed.

Mr. SHAPIRO. Mr. Chairman, I am pleased to testify this morning on the question of measures affecting the organizational structure of the Federal Reserve System. To be present with an old friend and former colleague merely adds to this pleasure. As I understand from my correspondence with your able clerk and staff director, the committee is also interested in the "tenor of monetary policy" at the present time.

I would like to state at the outset that I regard an examination of possible changes in monetary arrangements in the United States as a desirable and necessary continuous surveillance of the central bank by the Congress to which it is responsible. I firmly believe that structural reforms in our monetary system should be undertaken when the need for such reforms is demonstrated.

I do regret, however, the intrusion of consideration of the "tenor of monetary policy" into these proceedings. I say this because even if the present course of monetary policy were letter perfect, it should not preclude the discussion and enactment of necessary structural changes which might improve the effective discharge of monetary policy in this country in the future.

It is my fond hope and expectation that the stabilization authorities in our society will learn to disassociate permanent, structural changes from short-run cyclical stabilization tactics. For if there is one lesson to be learned from past stabilization experience, it is that many proposals for cyclical stabilization, which by their nature require speedy action, are often bogged down in procedural questions on the assumption that the short-run change is in fact a permanent feature of our legislative code. If our stabilization record in the future is to show improvement over past performance, I believe we must learn this lesson well.

One of the basic proposals before this committee is the need for and desirability of changing the institutional arrangements prevailing in the central banking system in this country. It is regrettable that discussion pertaining to such changes often degenerates into name calling and bandying about of cliches. These tend to obscure the fact that the underlying changes which have taken place in our explicit economic goals, in the array of policy instruments available to attain these goals as well as the changes in the political setting, require that we reexamine the organization of the Government's stabilization agencies.

And let me try to give some examples of what I have in mind.

As an example of the changes to which I refer, when the Federal Reserve Act was passed in 1913, the only explicit goal of economic policy was price stabilization. Since this was the only goal and the only widely accepted instrument for achieving this goal was monetary policy, there was no conflict of agencies and no need for integrating policy objectives.

With the passage of years, however, another major objective of policy; namely, full employment, was introduced into the body politic. During this same period, fiscal policy or the relationship between Federal expenditures and revenues was recognized as a major contributor to the attainment of these goals. As the desire for economic growth was added to the array of goals, both sets of instruments were seen to be useful in achieving these goals. However, the increase in the number of goals gave rise to the possibility of conflicts among them. There thereby arose the need to make choices.

Since policy decisions are made by different agencies and since these decisions require trade-offs to be made among the various goals, our stabilization strategy requires coordination among the agencies to insure the pursuit of a common end. For if one agency takes price stability to be the critical goal and pursues policies appropriate to the attainment of that goal, while other agencies deem full employment or economic growth to be the more important objective of policy, we will observe conflicting policies which may indeed prevent the attainment of any of these goals.

For example, if the central bank, in its interest in price stability, maintains a monetary policy which dampens demand, the fiscal

policy of the Government in attempting to offset this policy will be forced to run larger deficits. With a deficit of sufficient size, it may be possible to offset this restrictive monetary policy.

However, we get a larger deficit than would otherwise be necessary to achieve and maintain full employment and thereby reduce national saving. In addition, the restrictive monetary policy results in higher interest rates and by lessening investment results in a lower growth rate at that full employment level. I cite this example simply to make clear the fact that the independent pursuit of different goals may make more costly the attainment of any one of them.

Just as these goals and instruments have changed over time, so too have our notions of the appropriate structure of the central bank in this country. It is well to recall that the Aldrich Commission proposed a central banking system to be called the National Reserve Association, a corporation with capital subscribed by its member banks and controlled by them. Among the issues fought in the 1912 campaign was the question of the form which central banking was to take in this country.

With their victory in that election, the Democrats pushed vigorously by President Wilson, passed the Federal Reserve Act. The party in power denied the regional Reserve banks the right to be represented on the Board and were responsible for making the Secretary of the Treasury the Chairman of the Federal Reserve Board, thus establishing the principle that the monetary authority was a public body.

In the inevitable compromises attendant on this conflict, a complex structure called the Federal Reserve System was created. Commercial banks were represented as owners of the regional banks. The officers of the latter, in turn, while elected by the commercial banks, were subject to approval by the Federal Reserve Board. Thus banking representation was assured and concessions to the regional needs of the country were incorporated in the 1913 act.

In 1935, the only major overhaul of the Federal Reserve System was enacted. In general the 1935 act centralized power in the Federal Reserve Board. At the same time, Treasury representation on the Board was terminated. The Federal Reserve Board was given explicit power to change rediscount rates recommended by the regional banks and the Board was given sole control over the variable reserve requirement that was enacted. The Open Market Committee, the most influential body of the Federal Reserve System, was to be composed of the regional Reserve banks, of which the New York bank was to be a permanent member.

I should add, in addition, that prior to 1935 the Open Market Committee was constituted, as I recall, exclusively of the regional bank officers, as was pointed out to me earlier this morning. So that in point of fact the 1935 act may be interpreted—

The CHAIRMAN. May I interrupt you there?

Mr. SHAPIRO. Yes, sir.

The CHAIRMAN. It is my understanding that the Open Market Committee, under the act of 1933, was composed of the designated Governors of each of the 12 Federal Reserve banks. It remained that way until the 1935 act.

I believe that is correct.

Mr. SHAPIRO. I believe you are correct, Mr. Chairman. I was referring earlier to—

The CHAIRMAN. Preceding that, they had informal meetings of a group that they referred to as the Open Market Committee—an official group—but recognized by the Board, as I understand it.

Is that your understanding, Professor Samuelson?

Mr. SAMUELSON. I think so.

The CHAIRMAN. All right; fine. Thank you.

Mr. SHAPIRO. While further centralization of central banking was reflected in the 1935 legislation, the regional banks were still left with an important participation in the policymaking role. My review of the evolution of the central bank in this country is meant to suggest that we have no *idé fixé* on what is the “perfect” structure for a central bank.

Control over the money supply of the Nation is a vital operating responsibility for stabilization in our economy. As such it is desirable that the central bank's activities should be harmonious with the other stabilization activities of the Government. How this is done is perhaps less important than that it should be done. At one extreme it has been suggested that the central bank should be a part of the Treasury.

On the other hand, there are those who would preserve the autonomy of the central bank from any Government pressure. Our own central bank occupies a position midway between these extremes. It operates under a congressional mandate which can be charged should the Congress be dissatisfied with the Fed's conduct of policy.

Since the congressional act is broad in scope and provides wide discretion to the monetary authority, there remains a great deal of latitude within which the Reserve System can operate. It is precisely because of this degree of freedom open to the central bank that we must strive to eradicate any elements of doubt about its responsiveness to the public will and the discharge of its obligations as a Government agency.

Because of historical anachronisms, the present structure of our Federal Reserve System contains many vestigial remains which positively do it no good and, in point of fact, lead to suspicion as to its ultimate motivations. Precisely because I am interested in maintaining the presence of a central bank midway between these polar positions, I tend to support the following recommendations on Federal Reserve structure which were put forth by the Commission on Money and Credit.

The FRB Chairman and Vice Chairman should be designated by the President from among the Board's membership, to serve for 4-year terms coterminous with the President's.

The FRB should consist of five members, with overlapping 10-year terms, one expiring each odd-numbered year; members should be eligible for reappointment.

Occupational and geographical qualifications for Board members should be eliminated. Instead, the statute should stipulate that members shall be positively qualified by experience or education, competence, independence, and objectivity commensurate with their responsibilities. Salaries of top officials throughout the Government

should be sharply increased, and in view of the gravity of their responsibilities, FRB members should be compensated at the highest salary level available for appointive offices in the Government.

The present statutory Federal Advisory Council should be replaced by an advisory council of 12 members appointed by the Board from nominees presented by the boards of directors of the regional banks. At least two nominations, not more than one of them from any single sector of the economy, should be presented by each bank. The Board should make its selection, one from each district, in such a manner as to secure a council broadly representative of all aspects of the American economy. Council members should serve for 3-year terms, not immediately renewable. The council should meet with the Federal Reserve Board at least twice a year.

An important internal source of advice should be further recognized and strengthened. The law should formally constitute the 12 Federal Reserve bank presidents as a conference of Federal Reserve bank presidents, to meet at least four times a year with the Board, and oftener as the Board finds necessary.

The determination of open market policies should be vested in the Board. In establishing its open market policy the Board should be required to consult with the 12 Federal Reserve bank presidents.

The determination of reserve requirements should continue to be vested in the Board. In establishing these requirements the Board should be required to consult with the 12 Federal Reserve bank presidents.

The present form of capital stock of the Federal Reserve banks should be retired. Instead, membership in the System should be evidenced by a nonearning certificate for each member bank.

As I envisage the outcome of incorporating the aforementioned changes in the structure of the Federal Reserve System, we would confine voting on the open market committee to the same publicly appointed members who have the only votes when reserve requirements or rediscount rates are at issue. Put differently, the five presidents with present votes would be in an identical position as the seven presidents who attend, offer expert advice, but do not vote.

I would urge a word of caution with regard to this suggestion because I am impressed by the quality of the bank presidents in the regional banks.

There are a remarkable number of trained professional people who have come up through the Federal Reserve System whose judgments and training, I regard as a valuable national asset.

It has been suggested by many thoughtful officials of the Reserve System that the removal of voting responsibility from the Reserve bank presidents might result in their resignation from the System. The cost of such an outcome could be very high since the training and stature of many of these officials is extremely valuable.

Therefore I would urge a very deliberate evaluation of the likelihood of such a prospect before I would enact legislation incorporating recommendations to change the present structure of the open market committee.

In order to free the Federal Reserve Board members from the numerous demands made on their time, thereby enabling them to concentrate on the proper determination of monetary policy, I would urge consideration of a suggestion made by Governor Robertson.

Bank examination and supervision, as well as issues pertaining to bank structure, should be removed from the Board, and given to a newly formed Federal Banking Commission which would perform the functions now done by the Federal Reserve Board, the Comptroller of the Currency, and the FDIC. The latter organizations presumably would disappear.

In addition to these recommendations concerning the Federal Reserve System, I would like to conclude my comments with some suggestions concerning the execution of the policy decisions by the Federal Reserve Board.

The provision of reserves available to the banking system should be determined in a longer run context than appears to be the case at the present time. Preoccupation with the minute variations in the financial markets tends to cause erratic behavior on the part of the Fed, and subjects these markets to uncertainties which, in my opinion, are not helpful either to the outcome of monetary policy or to the effective functioning of these markets.

I believe that the bond market is more viable than is suggested by the Fed's almost minute concern with it. Moreover, the concern with the state of the bond market appears to me to constrain the Fed in pursuing monetary policies which might substantially affect bond prices.

In this sense, I agree with the Commission on Money and Credit report, when it states:

The monetary authorities should make full use of the fact that monetary measures can be varied continually in either direction and reversed quickly at their discretion.

If, in fact, our economic system contains more rigidities than was true in the past, I believe a more active response to projections in the rate of change of economic activity may be desirable. For, if the Fed delays its action in the face of an increasing number of signs of recession, and then later reacts with an overactive policy of increasing reserves, it tends to get the worst of two worlds. That is to say, unemployment is larger than it need be, and the subsequent increase in economic activity tends to be associated with more price rise than is necessary. The latter need not occur but, as I view the postwar record, it has in fact occurred because of the caution exercised by the Fed in putting on the breaks during the upswing. In my judgment, this hesitancy to tighten the reserve positions of the banking system stems from their concern about the response of the bond market to such action.

As I see it, the primary function of the Federal Reserve System is to determine the appropriate level of bank reserves. However, in a banking system with 14,000 institutions, many of which are small unit banks, there should be a mechanism to assure their liquidity.

If the discount window were made a right instead of a privilege, this liquidity would be assured to the individual bank and, in my judgment, the following two advantages would result. By allowing each bank the right to rediscount, the Fed need no longer be concerned about temporary losses of liquidity for individual banks as it pursues a policy of reducing the reserve base. The right to secure reserves might also have the effect of encouraging more venturesome lending on the part of commercial banks, as they would now be protected from



a reduction in liquidity in the event that some of these loans are not payable at maturity for cyclical, local, or regional causes. Insofar as this policy shifted the lending practices of commercial banks toward more venturesome loans, it may contribute to more rapid economic growth.

However, as it is the responsibility of the Federal Reserve System to control the reserve base, any increment to reserves over the target established by the central bank would have to be offset by corresponding open-market sales.

In return for the right to rediscount, a penalty rate, conceivably progressing with the extent of the rediscounting, would be exacted. An alternative mechanism to maintain the control over rediscounting, and to assure control over total reserves to the monetary authorities would be to provide the right of rediscount to a bank only if its assets do not increase while it remains in debt to the Reserve bank.

Finally, while the Fed has an enviable record of providing information to the public, compared with most other central banks, I believe much more could be done in this area. Subject to the constraint that information should be revealed only when it would not compromise the effectiveness of changes in monetary policy, the Board should be encouraged to report in full on its reasons for changes in policy, and on the evidence which was available to it in arriving at its decisions. I am persuaded that such material would enable scholars to examine in detail, and insulated from policy needs, the rich body of data on the operations of monetary policy. The present long lag between action and reporting, and the sketchy nature of reporting, tends to generate rumor, misinformation, and confusion. Thank you very much, Mr. Chairman.

The CHAIRMAN. Thank you, sir. Professor Samuelson, you may proceed, sir; and, after you gentlemen have concluded your statements, then the members of the committee will question you.

#### **STATEMENT OF PAUL A. SAMUELSON, OF MASSACHUSETTS INSTITUTE OF TECHNOLOGY**

Mr. SAMUELSON. Mr. Chairman, I am pleased to testify here this morning particularly, along with my old friend, Professor Shapiro. I should warn you that academic people, like us, disagree. I used to be at Harvard, and I am now at MIT. Professor Shapiro used to be at MIT, and he is now at Harvard. I cannot help but think that one of us has made a mistake in judgment, although possibly two of us have.

I shall merely summarize the highlights of my submission on the assumption that it will be entered into the record in its entirety.

The CHAIRMAN. Yes, sir.

(Professor Samuelson's complete statement follows:)

#### **TESTIMONY SUBMITTED BY PROF. PAUL A. SAMUELSON, OF MASSACHUSETTS INSTITUTE OF TECHNOLOGY**

##### **EVOLUTIONARY FEDERAL RESERVE REFORM**

Consideration of the economic principles of money and credit, the American constitutional system of pluralistic checks and balances, and the experience with central-bank operations in the history of the major free nations, leads me to the following conclusions.

(1) The present Federal Reserve System, the Board of Governors in Washington, and the 12 regional Federal Reserve banks, has evolved toward becoming a tolerably effective central bank—from beginnings in 1913 which, while understandably defective in many important respects, did represent a major reform.

(2) Further evolution is both inevitable and desirable, particularly in making the Federal Reserve at responsible institution in the American political structure. Whatever may have been true in a few countries for a few decades in the 19th century, there can never be a place in American life for a central bank that is like a Supreme Court, or 1831 House of Lords—truly independent, dedicated to the public weal but answerable for its decisions and conduct only to its own discretion, and to the consciences of its men in authority as they each envisage their duty.

(3) Lack of coordination between monetary, fiscal, and debt policies, as determined by the Executive and Congress, with monetary credit, interest, and debt-management policies, as determined by Federal Reserve policy, can lead to short-run crises and to costly longrun ineffectiveness. Yet, at this stage of Federal Reserve evolution, there is nothing to prevent tragic recurrence of such undesirable conflicts. It has been more of a lucky accident than an inherent feature of present legislation and practice that the United States has been able to avoid costly friction; but, not even with our lucky combination of personalities and events has our economy been spared some cost attributable to lack of unified monetary policy.

(4) A central bank that is not responsible is irresponsible, rather than independent. To be responsible means to be responsive. It need not mean being responsive to each month's 50.001 percent of democratic opinion; or being responsive to the articulate minority which at the moment seems stronger than any other minority.

But it does mean being responsive to the changing values, views, moods, and even fads of the American citizenry. It does mean a definite relinquishment of an adherence to certain thought-to-be-eternally sound doctrines, dogmas, and principles. Neither Governor Strong, nor Montagu Norman, nor even Chairman Martin can perform the role of Peter, holding a thumb in the dike against the floods of what is considered to be temporary unreason. The days when continental central bankers could encourage capital flight and even engineer a run against the currency in order to bring an accredited government to heel and to fiscal probity were not good old days. In any case they are not our days.

A clique of discrete, prudent, self-restrained central bankers never had the power or the ability to run international finance well, despite tall tales and romantic legends. What is true is that international cooperation has often been somewhat effective in the past, often for good and occasionally for definite evil (although never consciously for evil).

(5) A jury of competent economic experts, drawn from the principal nations of the free world, would probably counsel the following:

The central bank (i.e., the Federal Reserve) should in the last analysis, but not in its day-to-day operations, be responsible to the Executive. The head people in the central bank can always protest; indeed it is their duty to nag when policies seem wrong. They can resign with a public blast. But when the Executive has lost confidence

in the top people in the central bank, he should have the power to ask for their resignations, with the opportunity for both sides to state their divergent views. The executive branch, in turn, being but one of our three major branches—Congress, the judiciary, and the executive—is subject to all the continuing checks and balances of our pluralistic Republic.

#### MY RECOMMENDATIONS

Speaking as an American economist, cognizant of our peculiar evolution of institutions and practice, I do not now recommend such a drastic change. Perhaps in the coming decades, we may evolve toward a similar system. The most important changes needed now seem to me to be the following:

(a) The 14-year terms of the Board members are too long. Staggered 6-year terms would seem none too short. Perhaps 4 years would be better.

(b) The Chairman of the Board of Governors should definitely be appointed by each new President, and should serve at the pleasure of the President. (Whether he should have to be selected from the Board members is not, I should guess, an important issue one way or the other.)

(c) The present Open-Market Committee gives too much representation to the regional banks, too little to the executive branch. At the most, there should be the President of the New York Federal Reserve Bank and 1 rotating President from the other 11 banks on it. At the least one member designated by the Executive should be on the Open-Market Committee if a committee with its functions, distinct from the Board of Governors itself, is retained.

(d) If an irreconcilable conflict between the Executive and the Federal Reserve were to ensue, it should be made clear that the Federal Reserve must yield, albeit with the right to full protest to both Congress and the public. The sole exception to this ultimate yielding should be in the case that Congress by explicit resolution of both Houses releases the Federal Reserve from its showdown subordination.

I have not tried to spell out the legislative details of the above recommendations and have deliberately left my wording general. The above recommendation, I believe, preserves the proper kind of independence of the central bank. Like the House of Lords, it should be able to delay innovations, to smooth down the volatile changes of public opinion and of thin majorities. But the central bank should never be thought of as an island of isolated power, as a Saint George defending the economy against the dragon of inflation and frenzied finance. As Edmund Burke said nearly two centuries ago:

The age of chivalry is dead—that of responsible, democratic government has succeeded.

Mr. SAMUELSON. First, the present Federal Reserve System—the Board of Governors in Washington and the 12 regional Federal Reserve banks—has evolved toward becoming a tolerably effective central bank, from beginnings in 1913 which, while understandably defective in many important respects, did represent a major reform.

2. Further evolution is both inevitable and desirable, particularly in making the Federal Reserve a responsible institution in the American political structure. Whatever may have been true in a few countries for a few decades in the 19th century, there can never be a place

in American life for a central bank that is like a Supreme Court or 1831 House of Lords—truly independent, dedicated to the public weal but answerable for its decisions and conduct only to its own discretion and to the consciences of its men in authority as they each envisage their duty.

I think that is an alien notion to our traditions and I think it is particularly an inappropriate notion for the present day.

3. Lack of coordination between monetary, fiscal, and debt policies as determined by the Executive and Congress with monetary credit, interest, and debt-management policies as determined by Federal Reserve policy can lead to short-run crises and to costly longrun ineffectiveness.

This has happened in many countries. I dare to think that we have not escaped from it in the United States, and it is germane to the present time.

Yet, at this stage of Federal Reserve evolution, there is nothing to prevent tragic recurrence of such undesirable conflicts. It has been more of a lucky accident than an inherent feature of present legislation and practice that the United States has been able to avoid costly friction; but not even with our lucky combination of personalities and events has our economy been spared some cost attributable to lack of unified monetary policy.

These costs are still with us. They go on all the time, and they are not to be recorded in the newspaper and are not to be measured by crises nor by changes in the legislative structure.

Fourth. A central bank that is not responsible is irresponsible, rather than independent. To be responsible means to be responsive. It need not mean being responsive to each month's 50.001 percent of democratic opinion; or being responsive to the articulate minority which at the moment seems stronger than any other minority.

But it does mean being responsive to the changing values, views, moods, and even fads of the American citizenry.

It occurs to me to quote E. B. White's definition of "democracy." As I remember it, he said, "Democracy is the recurring suspicion that more than half the people are right more than half the time."

And it is an illusion that we can create a body for all time which will protect us from our own mistakes—as Ulysses lashed himself to the mast and put wax in the ears of his shipmates so that he could, at the beginning, act as a trustee for himself when going through the Islands of the Sirens, protecting himself against the temptation when he heard the beautiful music, imploring the men to untie him and let him go on to his destruction.

I think that such a trustee notion was a delusion in every century but is peculiarly so today, and much of what is called the polar view on one side, that Professor Shapiro referred to, stems from a romantic belief in that illusion.

Specifically, real life does mean a definite relinquishment of an adherence to certain thought-to-be-eternally-sound doctrines, dogmas, and principles.

I want to warn you against some of my colleagues who I see will be testifying later. Many of them in their infinite wisdom, and their wisdom would have to be infinite to justify their position, will tell you there can be established once and for all certain sound principles

which can be set down and which can be followed and which ought not to be deviated from except in the greatest of emergencies.

I should like to say, in my fallible ignorance, that for 30 years I have been studying that philosopher's stone of sound principle and every morning, when I have worked hard and thought I have discovered it, by sundown I have discovered its flaws.

Neither Governor Strong nor Montagu Norman, nor even Chairman Martin can perform the role of Peter, holding a thumb in the dike against the floods of what is considered to be temporary unreason.

I emphasize the words "considered to be." Often such diagnoses are correct and often they are not, and when they are not the Nation suffers tremendously.

I do not know who the heroes are of central bank history but if you examine each one who was nominated in turn the results is disillusioning. When I began as a student, Montagu Norman was considered to be the hero. But any review of Montagu Norman must debit against his undoubted successes in the 1920's, his undoubted tragic errors in the 1930's.

Fortunately for the reputation of Governor Strong, but sadly for him, he died before the 1929 crash; the complete record is not there, but it seems doubtful that he could have avoided history.

The days when continental central bankers could encourage capital flight and even engineer a run against the currency in order to bring an accredited government to heel and to fiscal probity were not good old days. In any case they are not our days.

A clique of discreet, prudent, self-restrained central bankers, never had the power or the ability to run international finance well, despite tall tales and romantic legends. What is true is that international cooperation has often been somewhat effective in the past, often for good and occasionally for definite evil, although never consciously for evil.

Let me turn to what a jury of competent economic experts, drawn from the principal nations of the free world, would probably counsel the following:

Now, there would be no uniform consensus among them but, as you look for the central tendency, I think you will find an agreement around the following paragraph. It is not my recommendation to you at this time, I should say.

They would probably say that the central bank, that is, the Federal Reserve, should in the last analysis, but not in its day-to-day operations, be responsible to the Executive. The head people in the central bank can always protest.

That is too weak. They sit on the councils making the decisions.

They have the right to formulate policy. They have the right to protest.

I think I am quoting Montagu Norman back in the 1930's, that it is the duty as Governor of the central bank to nag when policies to him seem wrong.

He can always resign with a public blast. Indeed, in a well-running system the finest hour of the Governor of the central bank is often the hour in which he resigns with a full protest, perhaps bringing down a house of cards or a more solid house about him.

But when the Executive has lost confidence in the top people in the central bank, he should have the power to ask for their resignation,

with the opportunity for both sides to state their divergent views. The executive branch, in turn, being but one of our three major branches—Congress, the judiciary, and the executive—is subject to all the continuing checks and balances of our pluralistic Republic.

Now, that would be the consensus of responsible economic opinion in a random country in the free world.

But I am now speaking as an American economist, cognizant of our peculiar evolution of institutions and practice, and so I do not now recommend such a drastic change. Perhaps in the coming decades, we may evolve toward a similar system.

I would like to stress the evolution of the Federal Reserve though. For even without changes in charter, this has been a pragmatic fumbling procedure of trial and error and correction. Open market operations which we commonly regard as the most powerful tool of the Federal Reserve were not envisaged by the creators of the Federal Reserve System.

And it was more or less in the state of absentmindedness that we stumbled upon them in Governor Strong's era.

The general tenor of my recommendations would be something like the following:

(a) The 14-year terms of the Board members are too long. Staggered 6-year terms would seem none too short. Perhaps 4 years would be better.

I have no strong feelings on the exact details of the change.

(b) The Chairman of the Board of Governors should definitely be appointed by each new President, and should serve at the pleasure of the President. Whether he should have to be selected from the Board members is not, I should guess, an important issue one way or the other, particularly after you shorten the terms of the other members.

May I interject here the unwritten constitutional law of the American system? I can speak as authoritatively on it as anyone, because nobody can speak with any authority on it at all.

According to the unwritten constitutional law, if one had been testifying here 5 years ago or 10 years ago or 15 years ago or 25 years ago he would have said that the Chairman of the Federal Reserve Board does serve at the pleasure of the President because he would have said, "As everyone knows, the Chairman hands in his resignation to the incoming President."

Actually I do not think anybody knows anything about that subject. It is not written in the records anywhere.

It has, as far as I know, never been put to a test and the unwritten constitution is not a constitution that you can depend on. It is not only unwritten but it is unformulated, unlike some parts of the British Constitution.

(c) The present Open Market Committee gives too much representation to the regional banks, too little to the executive branch. At the most, there should be the president of the New York Federal Reserve Bank and one rotating president from the other 11 banks on it. At the least one member designated by the Executive, perhaps the Secretary or Treasurer, should be on the Open Market Committee if a committee with its functions, distinct from the Board of Governors itself, is retained.

If a separate committee of the Board of Governors is not retained then there will have to be created, according to my view, some new committee which has some representation of the executive branch on it.

(d) If an irreconcilable conflict between the Executive and the Federal Reserve were to ensue, and this would happen very rarely, it should be made clear that the Federal Reserve must yield, albeit with the right to full protest to both Congress and the public. The sole exception to this ultimate yielding, and this is what I venture as a possibility, should be in the case that Congress by explicit resolution of both Houses releases the Federal Reserve from its showdown subordination; only in that case would the Executive not prevail in the case of an irreconcilable conflict.

I mention this explicitly because I think no responsible or irresponsible member of the Federal Reserve System would claim that the Federal Reserve System is independent in this caricature sense that I have described "independent." Most representatives of that agency and historians of that agency would feel that the Federal Reserve is responsible ultimately to Congress. And I believe that to be the case, but I think the nature of that responsibility has to be spelled out.

I have not tried to spell out the legislative details of the above recommendations and have deliberately left my wording general. The above recommendations, I believe, preserve the proper kind of independence of the central bank: like the House of Lords, it should be able to delay innovations, to smooth down the volatile changes of public opinion and of thin majorities. But the central bank should never be thought of as an island of isolated power, as a St. George defending the economy against the "dragon" of inflation and frenzied finance. As Edmund Burke said nearly two centuries ago:

The age of chivalry is dead—that of responsible, democratic government has succeeded.

Thank you.

The CHAIRMAN. Thank you, sir.

I would like to comment just briefly before asking questions.

You gentlemen have covered these subjects very fully, more fully than the witnesses I believe that we have had so far, and the members of the committee and I certainly appreciate what you have said. Even if I do not agree with you 100 percent I still value your testimony and I value your statements.

The question on the terms of office is this: Last year Mr. Kennedy, President of the United States, was privileged to select the Chairman of the Federal Reserve Board which, I think, is one of the most important positions in the free world, more important in many ways than the Presidency. He can do more to veto things than the Congress of the United States.

The President was in a straitjacket. He did not have freedom of choice because of the law passed way back in 1935 specifying 14-year terms, and there are only about two selected during a President's first 4 years and then during the first 2 years of the second term, the limit allowed by the Constitution, he can select two more.

In other words, it would be in the last 2 years of a President's second term of 4 years in office that he would be allowed to select a majority of that Board. Now, of course, in his last 2 years in office the President's power in influence declines a lot, we all know that.

So, during the effective term of the President, during the first 6 years, he has a majority that can work against him. Now, when Mr. Kennedy was permitted to select this Chairman of the Board, if he had been given the choice to select anyone in the United States that he wanted, I think it would have been much better, but under the present law he was compelled to take one of those seven members.

Therefore, he did not have freedom of choice. He only had one person on that Board who was selected by him. I believe that was Mr. Mitchell, from Chicago.

And, of course, there was Mr. Martin and all of these other people, but he had to take one of the seven. I do not look upon that as a healthy situation.

Would you comment briefly on that, Professor Samuelson?

Do you think that is a healthy situation? I believe your paper indicates it is not.

Mr. SAMUELSON. As indicated in my submission, I believe that the Chairman of the Federal Reserve Board should be chosen at the pleasure of the President.

The CHAIRMAN. Yes, I noticed that. That is good.

How do you feel about that, Professor Shapiro?

Mr. SHAPIRO. It seems to me I said a similar thing. I do think that there are differences, however, between Professor Samuelson and myself, although I would hardly regard them as substantive differences, for he suggests, as I understand it, a 4-year term for the Board members which presumably means that the incoming President could, in fact, appoint an entirely new Board—

The CHAIRMAN. That is right.

Mr. SHAPIRO (continuing). Upon his arrival.

The CHAIRMAN. That is right. That makes a difference.

Mr. SAMUELSON. Excuse me, but just to correct the record, I spoke of staggered 6-year terms or 4-year terms and did not spell out details.

I did not spell them out because I have no strong opinion—

The CHAIRMAN. But you mentioned 4 years.

Mr. SAMUELSON. Yes, but it does not mean though that you would have to have a new Board on Inaugural Day.

The CHAIRMAN. That is right. Now, really, the basic question here, gentlemen, is whether we are going to have a Board that is independent from Congress and the President, insulated against what they call politics and the electorate or whether we will have a Board that is under the supervision of the Government of the United States.

And they are trying to get over to the country now, "Keep the Federal Reserve out of politics; we don't want politics in the Federal Reserve."

The way I construe that, that is contrary to our form of government. Who put the Federal Reserve and monetary matters in politics?

The framers of our Constitution did it when they said that the Congress shall coin money and regulate its value. Of course, the Supreme Court has held that to coin money means to print money, too.

So, since the framers of the Constitution wrote that into the Constitution, to make it the duty of Congress, I construe that to mean that the monetary power, which is a very important power in any country, should be conducted and administered and supervised by the elected representatives of the people.



Then if a mistake is made or if they go against the public interest they have something to lose. They can lose their seats in Congress. They can be disgraced for life, be ruined in politics.

They have something to lose if they act against the public interest. But if you are going to have a Board that is insulated from politics, they have nothing to lose.

There is no way for the people, who vote, to vote against these people. They are off by themselves.

Do you agree with that statement on politics, Professor Samuelson?

Mr. SAMUELSON. I do essentially. If somebody said that we ought to divorce government from politics and have the executive branch removed from politics, the connotation is that we want to get away from graft, from petty intrigue, and all of those things.

But if somebody said that the Government should be divorced from statesmanship, it would have an entirely different ring. I cannot imagine having a city-manager-type of executive in this country, a man who makes decisions about public expenditures, recommendations about taxation, and so forth.

Similarly, I cannot imagine a city manager, a hired professional—I presume he would turn out to be a banker under those circumstances—given a subcontract to run the monetary affairs of the Government.

This is not a matter of politics statesmanship. It is a matter of responsible responsiveness to the wishes of the people in our Republic, as done with due process of law.

The CHAIRMAN. Do you believe that the Federal Reserve has assumed too much power now?

Mr. SAMUELSON. No; I do not know what the question means.

The CHAIRMAN. Well, here is what it means. They will not pay any attention to the President unless they want to. They feel like they are away from the Government. They feel like they are independent. Independence to them, if I can interpret what they say correctly, means that the President cannot tell them what to do and the Congress cannot either, unless Congress by a specific law instructs them.

They have bankers around them all the time. They should look after the general welfare of all the people, and they should be insulated from any special-interest group that could profit from their actions.

So it appears to me that it is dangerous to permit those who can profit most from the manipulation of the volume of money and the interest rates, to participate in the proceedings that make monetary policy.

What do you say to that, Professor Samuelson?

Mr. SAMUELSON. With all respect, Mr. Chairman, I should like to disassociate myself from the general line of that reasoning. I think I can put my position in the following way, that I give two cheers for the Federal Reserve.

I do not recognize two full cheers for them in your remarks. I do not give three cheers to the Federal Reserve because I think there are certain correctable deficiencies in their behavior.

But I think that my criticisms are perhaps less strong than yours, sir.

The CHAIRMAN. Would you like to comment on that, Professor Shapiro?

Mr. SHAPIRO. Well, I would like to comment in several ways on that.

In the first instance, it seems to me that the notion of an independent Fed, that is to say, independent of everybody but their own willful desires, I would regard as technically inaccurate, for the Congress of the United States indeed can change this by legislation and the Congress of the United States is responsive to the will of the public under the circumstances.

And I would submit that in the event that the Fed indeed did an outrageous thing, outrageous so that a hue and cry was reflected in the mail and correspondence to the congressional Members, that action indeed would be undertaken.

This is one line of argument.

On the other hand, I do believe that by virtue of the broad mandate which the Federal Reserve Board does have, it is in point of fact trying to kid some of us as well by talking about independence about which I think they imply independence of the Executive and for a broad range of problems I regard them as really pretty independent—period.

On the other hand, I do not believe that the Federal Reserve authorities are indeed people with malevolent intent. I think on some issues there are indeed differences in the primacy of goals, and until such a time as we could in point of fact stabilize the primacy of goals, I would regard individual judgments or individual actions as a consequence of a lack of consensus on a particular order of goals.

It is for this reason that I would regard the structural revisions which I suggested as making quite clear that the Federal Reserve authorities are indeed responsible to the public will and, indeed, for the most part, I would regard them as responsive to it.

So I, too, would disassociate myself from the line of argument which is implied by your comments.

I would say one further thing in this regard. I think Professor Samuelson was explicit about in the long run the central bank would be responsive to either the Executive or to the Legislature.

I would subscribe to this position wholeheartedly. I think both of us commented on the evolution of the Federal Reserve System, indicating that in point of fact this direction of movement has indeed taken place.

To revise legislation which starts on the assumption that there is indeed an antipublic desire on the part of the central bank, I would regard as insulting to the central bankers, and I would regard as destabilizing to our body politic at the present time, and therefore the character of the recommendations suggested by me, I think, are in effect much less radical. Despite the fact that I regard them as simply a continuation of that which has already gone on I suspect you will find newspaper accounts of the domination of the Federal Reserve System as a consequence of what I regard as relatively simple and straightforward structural reforms, designed to minimize any suspicion whatever of banker domination by our central bank, one of the most important stabilization bodies in our Government.

The CHAIRMAN. I want to make two comments, and then I will yield to other members.

One is on legislative changes. You know, in a democracy such as our own, there are a lot of people who have bottleneck positions, any

one of whom can say "No" and make it stick, but there is not one person in the United States who can say "Yes" and be absolutely sure. They just cannot do it.

Now, when you go to making legislative changes you first introduce a bill that is referred to a subcommittee. The subcommittee chairman can stop it if he wants to.

Then it passes out and it goes to the whole committee, and the whole committee chairman can have a lot of influence on it, and it can stop there.

Then it has to go through the leadership of the House and then the Rules Committee and those four bottlenecks—that is not all—just those four we see every day.

And then in the Senate it is the same way. So the chances of getting something really meaningful but opposed by an entrenched interest in this country, that is profiting so much by occupying a position that gives them special privileges, are rather remote because it takes only a few to stop things while a majority cannot always actually accomplish things.

So we have those deterrents to changes. So we should not speak of them glibly in that we can just go to Congress and get something done right quick. We just cannot do that.

It is too difficult in a democracy, as it should be. I am not saying that a change should be made. I think it is all right.

Another point is that the people, who handle the money, control the supply to a great extent and interest rates, perform the most important functions of our Government. The people who do that can veto the wishes of the President if they wish to.

They can veto the will of Congress if they want to. They can veto the program of the administration in power regardless of the politics.

They have a lot of power and certainly if you are going to have a board, it occurs to me, to channel these great problems and make good judgments for all of the people, they should be insulated from this special interest group like the bankers lining their own pockets with gold so easily, if they can influence the right decisions and they have not done badly in the past.

And if we are going to say that it is right to do that for the banks, let them have such a tremendous influence on the volume of money and the cost of money, why should we not do the same thing for the railroads, the truckowners, and the people in interstate commerce?

Let them be on the Interstate Commerce Commission or have representation there to fix rates, freight rates, and passenger rates?

Why should we not have the broadcasters on the Federal Communications Commission or have the Commissioners compelled to confer with the broadcasting industry before they can make any change and let them be heard in all important decisions and even vote?

It occurs to me that one would be just as logical as the other.

I will not pursue that because my time is up, but I will yield to Mr. Reuss.

Mr. REUSS. Thank you, Mr. Chairman.

I, too, am very grateful to both of you gentlemen for giving us your help and testimony this morning. I wish you were here for 2 years, as I would like to examine you at length. I will do the best I can with the time that is at our disposal.

Professor Samuelson, would the following be a fair paraphrase of your view of central banking and governmental relationships in the free world today: In most countries which have central banks, a dispute between the chairman of the central bank and the chief of state would require the resignation of the chairman of the central bank. In this country, if there is a dispute between the Chairman of the Federal Reserve and the President, about the only thing the President can do is to resign?

Mr. SAMUELSON. I do not think this has ever been put to the test, sir, but I think it is a fact of structure that in almost every nation of the free world it is beyond constitutional question that, when there is a pitched battle and difference, that the head of the central bank resigns.

I think there are some exceptions, but they are very few. And if you take a candid look at the trend, the changes in legislation in the last quarter of the century and the previous quarters of this century, it cannot be questioned at all that the trend is against the 19th century notion of an insulated central bank with unilateral power as against the Executive.

Mr. REUSS. With respect to our Federal Reserve Board of Governors, as you know, the President must soon appoint someone to one of the seven seats on the Board.

Would it be a good idea to have at least one member of the seven-man Federal Reserve Board of Governors who could discuss Board decisions publicly, whether by dissent or by making known the present thought of the Federal Reserve Board of Governors, much as the late Mr. Justice Brandeis and Mr. Justice Holmes did on Supreme Court decisions of another generation?

Would this be useful?

Mr. SAMUELSON. I think that there would be some usefulness in such a procedure, and I think that under the general recommendations that I have made we would be more likely to have it.

We do learn, late, the minutes of the meetings of the Open Market Committee. These are illuminating to scholars who have waited avidly for their publication. It is remarkable how close to one's surmises they turn out to be, but there are occasional surprises.

I think if you had a member of the executive branch on such a committee, and there was a real problem which the Nation should know about, it would come out very soon.

I do not think that under my recommended reform structure it would be desirable or necessary to try to create or recreate the Chamber of Deputies in the Federal Reserve Board, to have a labor spokesman, an agricultural spokesman, a female spokesman—

Mr. REUSS. You agree with Professor Shapiro that it would be not only necessary but desirable, to have an even more itemized—

Mr. SAMUELSON. Yes.

Mr. REUSS (continuing). List of representation that we have now?

Mr. SAMUELSON. Yes, but if you went to one of Professor Shapiro's poles—the one that never existed, of a truly independent monetary authority—I think you would then have to have on the Board a representation of every significant interest group in the Nation, and you would be creating kind of a dual governmental system.

Mr. SHAPIRO. Could I interject, Paul, that simply at that pole I would say the people who support that view would disagree with you

on the grounds that they want, in effect, to have a body which has some eternal wisdom which ought to be imposed on the body politic.

So that I think for anybody who would support that view, and I find it very hard to conjure up any such representative at the moment, I think that they would argue that they do not want—

Mr. SAMUELSON. But that is precisely my point, that the only conditions under which you could possibly let anyone get away with such a system would be to re-create a Congress within that which you call the independent central bank.

Mr. REUSS. But, getting back to the proposition which I put, taking the Federal Reserve System as it is today, would it be, in your opinion, a useful thing if there were at least one person out of seven who could publicly dissent and debate monetary policies with the majority of six?

Mr. SAMUELSON. May I answer that in this indirect way.

I do not like to comment on absolutely current matters, but let's take the situation as it existed before President Kennedy's election in November 1960.

The Federal Reserve Board then—and it was not a very different Board from what it is now—represented some very able people, drawn from various walks of life, and certainly no competent person would have reason to criticize the motives and abilities of a single member of that Board.

Nevertheless, it was definitely not representative of the central tendency and the dispersion of the middle-of-the-road economic thinking of this country.

Now, there have been only limited changes in that Board in the 4 years that have passed—

Mr. REUSS. Not such as to produce any difference—

Mr. SAMUELSON. I do not think that the difference has been great. In that sense, if you ask me would the addition of such a dissenter such as you described make it a Board more representative of the middle-of-the-road thinking and the dispersion around that middle-of-the-road economic thinking, my answer would be very positively "yes."

Mr. REUSS. What would you think of that, Professor Shapiro?

Mr. SHAPIRO. Well, I would not start with the notion that the President ought to appoint a dissenter. I start with the basic proposition that the President ought to have an opportunity to appoint a member to the Board and, more important, he ought to have the right within his term, at the beginning of his term, to designate the Chairman.

Now, the President may want a dissenter or he may not want a dissenter. Presumably he wants a man with whom he is compatible, presumably whose views are compatible with his as well.

And I would certainly favor that proposition by modifying the inclusion of "dissenter."

I do not care whether he is an assenter or dissenter but at least the President has a channel to that Committee—

Mr. REUSS. I do not believe I made my question clear.

I am asking both of you gentlemen to focus upon the Federal Reserve Board, as it now exists and as it has existed for some time. It has not changed in outlook very much, and I ask you to bear in mind what you have both suggested, that it is a pretty monolithic

board. There is no disagreement within the Board, apparent to the public, at the time decisions are made. Yet on the outside a great many very respected and, by no means, radical economists and financiers, may differ very deeply with the Fed.

My question is, in the light of this would it not be a good thing for the country if one member of the Fed turned out to be a maker of public dialogue on monetary policy?

There is not now such a member of the Fed. Oh, 15 months after the event we may find in the very turgid English of the annual report, that there was dissent but we have no notion of the kind of debate which occurred.

Mr. SHAPIRO. Mr. Reuss, I would say my notion that a full and complete record of both the reasons and the evidence for open market policy decisions, made available and made available quickly rather than latently, with a lag of something like 15 months and then really a report of brief comments would be very helpful in this regard.

And this is indeed why I make the suggestion that I do.

I suppose, being an eternal pacifist at heart, I would respond to your question by saying would it not be wonderful if we had a Board which really had common interests with the President so that you did not have dissenters and the need for dissent, but I appreciate that that is an unrealistic expectation.

Under the circumstances I would like to have a provision made so that the President does have some vehicle to this Board either by an appointment during his term or certainly, at the very minimum, the right to choose the Chairman, so that for any seven or five that were there, when he came into power, he could presumably discuss matters with them and try to choose from among them one whose views are compatible with his own views.

And I certainly see no reason for the secrecy surrounding policy questions with respect to the Federal Reserve System.

I think basically what you are concerned about is that there are understandable differences of opinion, and there ought to be a vehicle for a responsible party on the Board to make known his differences so the public is informed about differences that exist on the Board on any specific issue.

I do not know whether it is inherent in the Board or inherent in the selection process, but it seems to me that we have had some very strong Chairmen on the Federal Reserve Board in its history, and somehow or other one does not find an awful lot of direct information which would suggest the character of dispute or differences.

This would be, I think, extremely helpful for at the moment I am only subject to the availability of rumor, sometimes assertions on the part of people in the regional banks, who are trying to indicate that they are fighting. But it is hard for me to learn what they are fighting about and how valid their arguments are.

Well now, this ought to be available so one could check the points of view and the evidence on which different points of view are made for I think we do have lots of talent in the regional banks who, I am told, are causing more and more difficulty at the Board meetings.

But I do not know this to be a fact.

Mr. REUSS (presiding). Thank you.

Mr. SAMUELSON. May I interject a brief caveat there?

Mr. REUSS. Yes.

Mr. SAMUELSON. There are certain needs for privacy in the decisionmaking process when you are operating an open market operation on Government bonds.

And while I think that 15 months, as the maximum delay, is too long, I do not think that good policy requires that there be a televised version of each meeting of the Federal Reserve Board.

Mr. REUSS. Well, of course, nobody was suggesting that and actually my question involved an area broader than just open market operations.

For example, we have had hearings here for weeks and every representative of the Federal Reserve in Washington comes up here and sings exactly the same song.

Now, this suggests that this thing is a monolith, that members of this organization somehow lose their individual personality.

And my question is: Would it not be a useful thing if somebody in the Fed publicly disagreed with others in the Fed on these fundamental questions of economic policy?

Would not we be a better country if this happened? Your answer to that question was, Professor Shapiro, I gathered, yes.

Mr. SHAPIRO. Yes, except that let me repeat my concern, that I just do not want to appoint dissenters for the sake of dissenting.

There are differences of a point of view and perhaps it might be interesting to appoint one of the academicians that you bring down here who is peculiarly free with his advice in terms of not having to pay the price for seeing that advice executed, put on the Board, and see—study him experimentally in terms of his behavior patterns.

Is there something in the central banking process that does this or is it that the process is really very complicated and that the issues are not at all as simply and straightforward as some of us would have you believe?

Mr. REUSS. I agree that my proposal for public dissents would increase the number of public utterances, but I think that would be better than the "me tooism" that engrosses the organization today.

Professor Samuelson?

Mr. SAMUELSON. Mr. Chairman, I do not know how much time you want to use up on this particular question—

Mr. REUSS. Mr. Hanna, this is largely out of your time. Would you bear with me?

Mr. HANNA. Yes.

Mr. SAMUELSON. I think, to get a man which is or who is essentially associated with one strong policy which is entirely different from that of the majority so that you can predict that he will dissent on every vote would be an absolutely futile procedure.

It might bring some publicity to bear upon the matter, but Justice Brandeis was not a great dissenter because he often dissented, but rather because he dissented in a certain way and on certain issues and because he dissented early in a direction that history decided was the correct side.

Mr. REUSS. My complaint though is that almost nobody dissents on anything.

Mr. SAMUELSON. Yes. Now, may I go to the problem of the unanimity of the Board when confronted by the enemy, the family toward the parent?

The Board is responsible to Congress, so naturally, as we must all feel toward our parents, there is a certain element of fear involved.

It is not feasible even within the executive branch——

Mr. REUSS. Fear of the parent or fear of reprisals by the other children?

Mr. SAMUELSON. Well, that is my point. It is not feasible within the executive branch or at least it does not make for a good way to run a railroad to have each general and admiral completely a free wheeler on his own in the Defense Department testimony.

Now, if I may comment on the problem within the Board—and now I cannot stand on the grounds of solid fact, documented, but will merely say things that every schoolboy knows—there was an issue in the Board at the time of 1952 and for some time afterward of “bills only” or “bills preferably.” For once, there did develop a cleavage of opinion within the System on this issue.

That was healed gradually over time. It would be only human nature and only in accord with the nature of every institution if, at some point in that conflict, the people involved who were on the losing side should suddenly discover that it is not expedient to continue to be on the losing side; and so then, against their own convictions, they began to change their opinion.

Now, I cannot document this with microfilms or pumpkins, but I am sure that there were such people in the Reserve System who felt themselves silenced because of feared reprisals from the other children and also from some of the older children in the family.

My image of the real politic within the Federal Reserve System is somewhat different from that of Chairman Patman who has left the room.

I think there have been many times when the provinces have been more nearly right than the center, but that the focus of power has been going toward the center, toward Washington, rather than toward the 12 regional banks; and that sometimes the people out in the provinces have been more on the side of the angels, as I interpret the side of the angels, than the people in the center.

Mr. REUSS. Thank you very much. Mr. Hanna?

Mr. HANNA. Thank you, Mr. Chairman. I could not help but recall, when I listened to your testimony, Professor Samuelson, a comment that dogma is deadly and truth is illusive.

To that I have tended to graft on that at times of rapid change dogma is more surely to be deadly and illusiveness of truth is bound to be more intense.

It seems to me that the more protected an institution is and the more important its functions are the higher the probability is that there will emerge some kind of dogma and that the justification of whatever actions they take will be against the framework of that dogma, as perhaps a choice against the illusive chase of truth.

And there is going to be less patience with the judgments that are admitted to be unsure and subject to admission of error, and I think perhaps we are as much to blame for that as the people we put in these kinds of institutions for these rather awesome duties, because they can be sure that our judgments or their judgments are going to be pretty harsh, too.



So I think that perhaps we participate in this sort of thing and, therefore, I think that the critical analysis should be directed toward the kind of institution we have made, in its essence, and I think that is the kind of critical approach that you gentlemen are making as against what the Chairman's position seems to be.

But I wondered, looking at that, is it not basic here that one of the reasons that we cannot have the members of the Board too independent is that their actions are in no sense independent of politics?

In other words, let's say that we try to make the members of the institutions separate from politics but we cannot separate decisions they make from politics; can we?

Mr. SAMUELSON. You cannot separate your policy from politics, in my opinion, but there is one thing that is true and let me illustrate by a problem that has come up again and again.

If you read brokerage letters, the financial page, and the political pages, you will read—in a year like 1956 or a year like 1960—that interest rates will not tighten because this is an election year and the party in power wants to be reelected and, naturally, the Federal Reserve which was thought in those years on the whole to favor the party in power, will do something about it and politics will enter in and that will change the betting odds on the bond market. That is rot. That just is not factually the case.

I thought this rot in advance of the time when this was a matter of discussion. The Federal Reserve, if you fully examine what it did, if anything, tightened money—which is supposed to be bad politics for the administration in question, both in the 1960 election and the 1956 election period.

I think that it did this because, in its fallible judgment of the business cycle situation, leaning against the wind called for a continuing tightening, or countenancing of natural tightening.

So, in that sense, there is a divorce of Fed practice from petty politics.

Mr. HANNA. I was not speaking of politics in a petty sense because I am rather sensitive about doing that, as a politician, but I was thinking of politics more in the fact that no matter for what reason they did what they did it would have an effect upon the political situation.

That is what I am talking about. I am not talking about their motives or anything about that.

For instance, supposing, as Dr. Shapiro suggests, that perhaps by looking at the bond market they make a decision to do something that they think, looking at the bond market, seems to be dictated.

Well, the effect of what they do does not flow back strictly to the bond market, if that happened to have been their point of reference.

What I am suggesting is that the effect of that decision has a much broader spectrum of cause and effect, involving the position of the President who might be running for office, the position of the Labor Department and that may be trying to effect the policy of employment, and the position of the Treasurer in terms of his trying to effect some policy there.

Now, am I wrong about that?

Mr. SAMUELSON. No; I agree completely with you.

One of the problems, for example, that the central bank has to wrestle with in any country is what is the proper compromise if a

compromise is necessary between complete stability of the price level and the complete attainment of 96 percent of the labor force employed.

Now, that is a policy issue. I think it is ridiculous to think that this could be jobbed out on a subcontract to some independent group to make a decision.

By the way, they do not make a decision about the whole thing, but they make a decision about one part that impinges very importantly on the outcome. The result has been that we have gone along with the image of an adversary procedure, where it is the business of the Federal Reserve, the central bank, to worry about the price level, as if that was its brief, and its mandate; while it is supposed to be the business of somebody else, I suppose the executive branch—you cannot call it the Treasury because the Treasury does not decide these things—to determine what the unemployment rate will be and what the rate of growth will be.

You cannot divorce these two.

But if you try to, you will get something like what we have had in recent years; namely, a biasing of policy toward fiscal ease which means a low-capital-formation economy, because we keep tighter money and we offset it by a looser fiscal policy.

I am here leaving the international balance-of-payments problem aside for a moment, even though you can leave it aside only for a moment.

What we see in the tax bill is an example of that. We are encouraging the use of resources by tax reduction in the direction of current consumption, even though it is true that there are aspects of the tax bill which have a bearing upon capital formation. And the Federal Reserve is prepared to—in fact, it has warned us that it is prepared to—mop up any inflation that may result from that by tightening money and credit, which means putting the tourniquet around capital formation.

Well now, under such a procedure, where I can only move the white man in chess and you can only respond with the black man in chess, you are not going to get the optimum from anybody's point of view.

Mr. HANNA. Let me say that all I can do is be astounded by your brilliance since yesterday that was the same analysis I made except I was talking about jousting between knights.

Mr. SAMUELSON. If I may say so, I am not a bit astounded by your brilliance.

Mr. HANNA. Well, Professor Shapiro, would you comment on the other aspect of the same thing, about our getting in a position of a buyoff between one policy as against another?

In other words, that is really what it seems to me that it amounts to, is it not, that we get to a point where we have to—I mean, how much growth are we going to get as against how much risk of inflation?

Are we not put in that kind of a position?

Mr. SHAPIRO. Mr. Hanna, I will respond to your very pertinent question in just a moment.

I would like, however, for the record, to clarify a statement made in my earlier presentation which might, indeed, have been misinterpreted.

When I commented on the present occupation of the Fed with the state of the bond market I did not mean to imply that the Federal Reserve authorities were concerned with the income and wealth of commercial banks or bond dealers, I think in—

Mr. HANNA. Oh, I understand that.

Mr. SHAPIRO. I think, in complete integrity, they regard this market as one which needs minute care, a view which I do not share for precisely the reason that I believe an enterprise society has very large elements of strength, and it is only in that context that my earlier remark ought to be interpreted.

With respect to the tradeoffs, the question that you posed earlier, I think my response to your comments would be, as fairly as I can do it—I would think that the Federal Reserve authorities are preoccupied with stability of the price level in such a way that when compelled to make a choice they tend to err in the direction of price stability, whereas I would personally regard getting to the utilization of our full capacity as a primary goal in our society.

Now, these are reasonable differences. I would assume that they would argue that they really are interested in the same end as I, and they regard changes in the price level as deleterious to the accomplishment of what we would regard as single goals.

However, I do think it makes a difference in terms of the ultimate outcome for I am not as panic stricken by the prospect of a price rise and, indeed, many of the cliches that we have heard in recent years, namely, that the Congress would move with great rapidity to cut taxes but would not move with respect to raising them, is hardly a description of either of the late President's initiative with regard to a tax cut or the Congress response to that.

So that, moreover, I think that we have enjoyed a remarkable period of price stability under the circumstances with widespread unutilized capacity.

I am much less fearful of the policy of ease, designed to insure that we arrive at a higher level of capacity of utilization, than we have thus far succeeded in doing.

Now, on the other hand, there is an issue on which Paul and I sometimes have had differences and I think they are honorable differences.

One thing that does worry me about the outbreak of inflation, if it should occur which I deem unlikely in the calendar year 1964, is that it will be associated in the minds of the public with a large debt or the tax reduction associated with the tax cut bill.

And from this I infer a public confirmation of a suspicion which does not have a bit of accuracy, as it has been used, that Government's debts are inflationary.

And I am fearful, therefore, that if we do have an outburst of price inflation, particularly of the character of that in 1955-56 in this country, that we may set back fiscal policy, as a stabilization tool, for half a century which I would regard as a great tragedy from the point of view of our future stabilization tools.

And it is this sort of problem which I think lends somewhat more urgency to our ability to maintain price stability in the near term future than I would otherwise feel, but this would not compel me to, in point of fact, lead to a policy on the part of the Fed which

would cause a sharp rise in interest rates, in order to avert a rise in the price level, as we indeed do shift to higher levels of employment and output.

Moreover, I am not at all sure that the issue of price inflation, versus employment is put forth very well. In terms of the 2 percent per annum price increase, which is widely regarded as a sign of inflation, I would say it is simply a measure of the inappropriateness of our price indexes.

So that it seems to me that we are losing employment for the very wrong reason or for a very wrong reason, if the choice was between the 2 percent price increase and higher levels of employment and output.

Mr. HANNA. Well, I take it that my time has expired.

I would simply like to ask that both of you gentlemen might submit comments for the record or your statements relative to these two questions: Do you think that by having the incoming President, whoever he might be, have the right to determine who shall be Chairman of the Board and a lessening of the present stretch of service, the term, would in any way impair the powers of the Board and its flexibility and the utilization of that power; and (b) would it deteriorate in any way the quality of the men who might be available for these positions?

That is all, Mr. Chairman.

Mr. REUSS. Professor Shapiro, you make a number of very fundamental suggestions with regard to the Fed; first, in the seven changes recommended by the Commission on Money and Credit Report and then, in your additional suggestions, including the recommendation of Governor Robertson on bank supervisory functions.

I would like to explore with you what the adoption of these changes would involve. I should like, in particular, to discuss two of these changes.

If we took the Fed out of the business of bank examination and supervision and formed a Federal Banking Commission to take over those functions, plus those now exercised by the Comptroller of the Currency and FDIC, would not the functions of each of the 12 regional Federal Reserve banks then consist largely of two things:

One, of having its President act as an adviser to the Board in Washington on monetary policies—open-market policy, reserve-requirement policy, and rediscount policy—and, two, of carrying out its present responsibility with respect to check clearance? Would it not about boil down to that?

Mr. SHAPIRO. Well, Mr. Reuss—

Mr. REUSS. Not that that is not plenty.

Mr. SHAPIRO. I think, in point of fact, that the regional banks at the moment have two functions, really the housekeeping functions including check clearance, bank examinations, and so on, and then the regional intelligence for the Board in Washington are necessities appropriate to providing that intelligence to the Board in Washington.

Now, currently there is a third feature, namely, that this intelligence is required for the four non-New York bank Presidents who will serve on the open-market committee, and I envisage my proposal or let me say my confirmation of the Commission's proposal as

really giving that policymaking function as much importance under this scheme as it does under the present scheme.

Fourth, the Presidents would be indeed the important advisers to the Board but they would not have a vote, and the economic intelligence function, which is currently performed, would still be performed and would still be required in a country as large as this, with as much regional diversity as it now has.

So that one of the issues really turns on whether, in fact, you think the high quality of the personnel in the Reserve bank presidencies that we have acquired in recent years would cease when their vote was taken away.

As I commented to you a moment ago, I have a kind of an experimental turn of mind. I would like to see whether, if these men were given votes on the Board and were given salaries commensurate with the Board's salaries, not their current salaries, whether this would be more of a deterrent to their staying than the present system, where five of them have the right to vote but there are also associated with this, salaries which in point of fact are higher than most of the Government salaries and mostly for commensurate responsibilities.

Mr. REUSS. "Most" is an understatement. While the President of the United States receives a salary of \$100,000, the President of the New York Federal Reserve, with a salary of \$70,000 a year, receives compensation three times that of the Secretary of the Treasury.

Mr. SHAPIRO. Excuse me, but let me answer your question very directly. I fear that this was a very circuitous response.

I would say that under the proposal as I envisage it, the responsibilities to the public, that the Reserve bank presidents now have, would still be maintained for they would participate as advisers in Open Market Committee deliberations.

Mr. SAMUELSON. May I put in the record a recommendation about salaries at some stage?

Mr. REUSS. You certainly may. Without objection it will be received.

(The recommendation referred to follows:)

The top salaries of Board members are woefully low and should be raised substantially by Congress. The following inserts from my regular end-of-the-month articles for the Washington Post give some of my views on monetary policy.

[From the Washington Post, Nov. 24, 1963]

#### HOW TO BE A CENTRAL BANKER

Lord Chesterfield wrote letters of wisdom to his son, and F. Scott Fitzgerald wrote similar letters to his daughter. In my children's house are many bedrooms. And, who knows, someday I may be able to speak of my son, the central banker.

This then is a most appropriate time for a letter of wisdom from an academic Polonius like me to a new member of the Board of Governors of the Federal Reserve. Here are my five commandments.

I. *Thou shalt vote immediately to raise your own salary.*—This is no jest. A Board member now receives a salary that was too low 20 years ago. Today you can't even get a dean for such wages, much less a Presidential naval aide. To be sure the job has 14-year tenure, with possible reappointment for not too outstandingly good behavior. The pace is not frenzied; the pressure not great. The cafeteria and tennis courts are among the best in Washington, and it is not a bad post to retire to.

Still, as Adam Smith pointed out, it is poor economy to underpay people who handle a great deal of money. And it is a fact that technical experts in any organization have their pay held down by the pay scale of the bosses. The

excellent staff of economists and statisticians at the Fed will decline in quality and, what is not the same thing, will increase in average age if the anomalous situation continues to prevail in which college professors receive higher salaries than public servants.

Since the Reserve System claims to be independent of the Executive, strike a blow for freedom and do not wait for the long-delayed rise in Executive salaries. Set the pace for once. Better still, legislate a sliding scale with a General Motors yearly "improvement factor" in the salary level. What's good for General Motors sometimes is good for the country. The profession of central banking, like that of teachers and philosophers generally, is one of those sectors with slow productivity growth: if the wives of its practitioners are to share in the rising trend of living standards, hourly wages must rise there; this need not involve any overall inflation—or what might be equally sinful—any violation of the Kennedy-Heller wage-guide formulas.

Where is the money coming from to finance these increases? Are you kidding? Anyone who asks that question is thereby disqualifying himself for the job of central banker.

II. *On taking office do not divest yourself of your common stocks.*—Remain a member of the human race and invest your assets in a mediocre balanced mutual fund, which holds the conventional one-third of bonds and two-thirds of equities. (I needn't recommend a particular mediocre fund; serious scientific investigation shows there is no other kind.)

These recommendations on petty personal finance are not trivial. Just as Gibbon was said to have often confused himself with the Roman Empire, so there is an anthropomorphic fallacy that money managers fall prey to—of confusing the well-being of a steadily employed 55-year-old man with the interests of a great and diverse country. Please no conflicts of interest!

III. *Shake up the "Old Lady of Constitution Avenue" a bit.*—The place is getting a little stale. Remember you have tenure and 14 years from now most of the present Board will be retired.

Let me be specific. Everyone knows that the principal economists at the Federal Reserve in recent years have been Winfield Riefler, Woodlief Thomas, Arthur Marget, and Ralph Young. Ask any jury drawn at random from the 15,000 members of the American Economic Association, and you will learn that these have been gifted and respected experts.

But that jury will also report that they never represented four essentially different points of view. Nor three different points of view. Nor, as far as textual exegesis can determine, as many as 2.00 points of view. Granted this is better than a similar evaluation, which finds that Bank of England economists do not add up to even 1.00 points of view; still it is not good enough for a country of 190 million people.

IV. *Thou must do something about the public image of the Federal Reserve.*—An index number of scholar's confidence in the Fed. using 1928 as a base of 100, showed a steady postwar rise from 3 in 1945 to 73 in late 1952. The incompetent handling of matters in early 1953 sent this index confidence plunging down toward 50; there followed what technical chartists call a head-and-shoulders topping out, until the disastrously biased tight-money capers of 1956-60 created a crash in the index. Since then the index of confidence in the probity of the Federal Reserve has been painfully climbing back toward the level of 50.

How to improve the image? Sending Board members' speeches to the complete mailing list of the American Economic Association is perhaps not the most constructive move possible at this time. Institutional advertisers in the leading economic journals is probably too crude. You can't buy love; you have to earn it. The therapy must be fundamental and drastic.

V. *Stop being jockeyed into the underdog position of last defender of the stability of the price index.*—The universe was not created with a basic division of powers; the Government being under obligation to use its fiscal policies to produce high and growing real output; the Federal Reserve being under obligation to use its monetary policy to insure stability of the price level.

Such logic leads—indeed it did lead, even in the days before gold was a problem—to credit policies that are too tight and fiscal policies that have thereby to be so much the looser. The result, even at full employment, will be a bias against capital formation and a bias toward present consumption.

The founders of the Federal Reserve really didn't know what they were doing. But surely none of them thought they were designing an engine that would be a bulwark against growth.

Son, do something about it.

PAUL A. SAMUELSON.

MASSACHUSETTS INSTITUTE OF TECHNOLOGY, *November 1963.*

---

[From the Washington Post, Aug. 25, 1963]

### MONEY MACHINATIONS

#### I

A mysterious absence has been haunting the American economy these last half dozen years. What in the world has happened to our money supply? How is it that the total of currency in circulation and demand bank deposits subject to checking, which is what economists call the money supply, has failed to grow much since 1958?

President Kennedy fought his campaign on the promise to get America moving again. But all the President's horses and all of his men have apparently not been able to put the money supply back on its century-old trend of at least 3 percent growth each average year. Since the beginning of 1959, money has grown scarcely  $1\frac{1}{3}$  percent per year. There is a strong school of economists who think that, just as a teenage boy needs plenty of bread and ice cream to grow on, so does an expanding economy need its full ration of new money to grow on.

Money. Money. Money. That is their chant. Control it and you control the stability and growth of the system. Mismanage it, or let it mismanage itself, and you bring upon yourself boom and bust.

#### II

Bluntly, these economists blame the Federal Reserve for domestic stagnation since 1959. Most of them favored Richard Nixon in the 1960 campaign; then, and now, they attribute Kennedy's victory to the Fed's stranglehold over the money supply.

Chairman William McChesney Martin, Jr., of the Federal Reserve Board, is their scapegoat. While many of us have been rather pleasantly surprised by the flexibility of the independent Federal Reserve System in its cooperation with the Kennedy administration, the monetary theorists indict the Reserve System for currently contriving the tightest of tight money. They are scornful of the claim that interest rates have been kept from rising much in the present recovery. They point to the chart of "M," the money supply. Never before has it grown so little in  $2\frac{1}{2}$  years of recovery; and that, they insist, is the only valid criterion of whether money is too tight.

They regard the recent rise in the official discount rate as just the latest twist of the tourniquet, and an omen of more to come. Mr. Martin, Secretary Dillon, Under Secretary Rosa, and President Kennedy, they believe to be deceiving themselves. There is no way to tighten money for balance-of-payments purposes without having it clamp down on domestic recovery.

#### III

Suppose they are right. How would they handle the gold and international problem? Here the M-men divide into at least three camps:

1. Some simply dismiss the gold problem. Let us pay out what we have until we have no more and can then suspend gold payments and the gold standard. Or better still, they argue, simply let the dollar fluctuate in free exchange markets according to supply and demand. While this may sound irresponsible to lay people, this group presents elaborate argumentation to show we would have been better off since World War I on a free-exchange-rate rather than a fixed-exchange-rate system.

2. Others believe that free rates are undesirable or politically unfeasible. If domestic prosperity should create a gold problem, they favor direct interventions—like the interest-rate equalization tax on purchase by Americans of foreign securities, export subsidies, or capital controls. Better still, they favor

an eventual multilateral devaluation if prosperity and existing parities prove to be incompatible.

3. A final group expect that after prosperity has been achieved here by monetary expansion, interest rates will naturally rise enough to terminate short-term capital and gold outflows. After chanting "Money, money," they chant "Twist, twist." To keep money for domestic investment cheap they advocate the following.

(a) Mr. Roosa should stop fumbling around with lengthening the maturity of the public debt. He should float only short-term debt from now on, and buy up for the trust funds all long-term bonds whose yields compete with interest rates charged for plant and equipment financing.

(b) The Fed's Open-Market Committee should buy in long-term Government bonds: eschewing short-term bills, it can help keep their yields competitive with rates abroad. So far, "Operation Nudge or Twist," they believe, has been pursued only on a token scale.

#### IV

Here is my brief evaluation of these issues. Actually, money has not been quite so tight as this view alleges. Saving deposits which pay interest have been growing rapidly while checkable deposits have languished. Undoubtedly saving deposits are quite a substitute for demand deposits. If we broaden the definition of the money supply to include such deposits, we have been living in a very easy money period. The truth lies somewhere between the definitions which either completely include or exclude saving deposits.

Nevertheless if it had not been for the balance-of-payments problem it would have been optimal policy in this era of unemployment and steady prices for the Federal Reserve to have made itself unpopular with the New York banking community by making money much easier than it has been. Some of the load could then have been taken off the politically burdened shoulders of fiscal policy. Private investment in plant, equipment, and housing could have been stimulated to accelerate the growth of our full-employment potential GNP. Even if one is an agnostic about the great potency of monetary policy a five-and-a-half-percent unemployment rate requires that all such remedies be given their trial.

Looking ahead, I agree that the Treasury and the Federal Reserve must do more than they have been doing to prevent the tightening of long-term capital funds that is developing as a result of the program to defend the dollar through the elevation of short-term interest rates.

The heat will grow. While economics is too serious a business to be put in the hands of the young Lochinvars from the West, even from the mouths of zealots come cautions worth pondering.

PAUL A. SAMUELSON.

MASSACHUSETTS INSTITUTE OF TECHNOLOGY, August 28, 1963.

Mr. REUSS. It seems to me that these advisers are going to be about the most expensive advisers in the world. First of all, they are paid up to \$70,000 per year.

Secondly, to help them in their advisory role, they have well-paid, well-staffed research establishments.

I wish the Banking and Currency Committee had the research establishment of at least one of the Federal Reserve regional banks.

Yet their primary function would be check clearance, that which is performed for many a city by an affiliate of the banks known as a clearinghouse. I have observed both. These institutions and their work look very similar.

Because the clearing functions of the regional banks do not require high-priced experts, you would in effect be paying astronomical sums for advice from the 12 regional banks. You see—

Mr. SHAPIRO. Yes, I—

Mr. REUSS (continuing). What you have done here is, first, to centralize policy functions in Washington, vesting these in the publicly appointed seven members of the Board of Governors, or however many you would appoint. I agree with this recommendation.



Secondly, you would be taking the nonmonetary policymaking functions out of the Fed and putting these under the control of a Federal Banking Commission which, I think, is also an appealing proposition.

This would leave the 12 regional banks with one highly paid President and a highly paid set of officers to run a glorified clearinghouse and a research establishment.

I am thinking now of the rather mundane subject of cost to the people, because the taxpayers foot the bill of the Federal Reserve in the end. To the extent that the Fed spends money, it cannot get back to the Treasury.

To ask my final question, could you not get the kind of regional advice needed without paying so frightfully much money for it?

It seems to me we could get honest and intelligent men from each of the 12 present districts to come in and advise the Board. But I do not see why you would have to pay the advisers three times the salary of Board members, besides giving them staffs which are the envy of the duly constituted monetary committees of Congress.

While we are at it, why could we not save a few hundred million?

Mr. SHAPIRO. Mr. Reuss, I think this is a very serious question, and I do not wish to be trivial in responding to it, but I cannot avoid the opportunity, however, of saying under our present system we are paying all of that for five minority votes or a conceivable five minority votes.

So I think that conceivably even if we maintain the present system I think your question is a relevant one to which I wish I had a handy answer.

Mr. REUSS. If I may interrupt you, under the present system, the 12 banks do some bank supervision, that is to say, they deal with State banks which are Federal Reserve members for roughly the same purposes as does the Comptroller of the Currency in dealing with the national banks.

Mr. SHAPIRO. Yes.

Mr. REUSS. But if you are going to take this supervisory function from them—and I must say it seems to me to be an irrelevant function for the Federal Reserve System—what you have left are these enormously expensive clearinghouses. At one address on Wall Street, you will have Mr. Hayes getting \$70,000 a year with a multi-million-dollar research service, running a clearinghouse, although he has in addition his Government securities business and his responsibilities in the foreign exchange area.

We will take Chicago. You would have in the Chicago Federal Bank a President getting \$50,000 or \$60,000 a year with a huge research establishment. But, unlike the New York Reserve banks, all in the world the Chicago bank would be doing would be an operation very similar to the Chicago clearinghouse down the street, whose manager is doing a highly competent job with a far smaller budget, particularly now that computers and electronic equipment reduce money operations to button pressing.

Mr. SHAPIRO. Well, I would say, for one thing, the multimillion-dollar research staffs in the regional banks, as you described them, ought to be carefully examined in terms of what do we get for what we pay, and I am not an expert, I do not know enough about what they do to make glib judgments that they are either good or bad—

Mr. REUSS. If I may interrupt at this point, should not their research output be shared by other governmental agencies?

The Treasury and the Department of Commerce, for instance, are interested in the state of the Union.

Mr. SHAPIRO. Yes, I think one possibility again, of course, would arise from the fact that conceivably, as a result of adoption of the plan I put forth, that the regional banks are regional economic intelligences of the Federal Reserve Board, and it may well be that you could save a substantial amount of money in terms of duplication which is done, which is unnecessary, and thereby free up resources to either be returned to the Treasury or the—

Mr. REUSS. For example, right now you have 13 congeries of people in the Fed who get out reports and essays on our international balance of payments.

We have 1 here in Washington and 1 in each of the 12 banks. They are wonderful people, but with the shortage of good people in the world could not just 1 of those 13 outfits contribute on the balance of payments, free up some of these others to do more useful work?

Mr. SHAPIRO. Oh, these national issues on which, as I agree with you, you look at the letters put out by the banks and there is a tremendous amount of overlap and duplication, I would expect, therefore, that you could either make a decision that you want to cut the total amount of resources devoted to the research function within the combined Federal Reserve System or, alternatively, say that you are going to do other things, that you are not now doing, with the manpower that you have on hand, on the assumption that these are substitutable men, which is not always the case.

So that I would think there would be an improvement in efficiency as a consequence of recognizing a delegation of responsibility, namely, the regional banks being a part of the Federal Reserve System's research and intelligence or research intelligence, thus the regional research staffs would be concerned with a careful and detailed knowledge of regional matters, and would free up those portions of the personnel in the regional banks that are duplicating what is being done in the other Reserve banks and in the Board itself.

I think there are economies to be gained from that.

With respect to the salaries paid to the Presidents of these banks, it seems to me that frequently, when people are perturbed about suggestions that the open market committee be revised to preclude voting rights to these reserve bank presidents, somewhere in their testimony later on they will talk about the need for paying these salaries to attract commercial bankers or people who have alternatives in commercial banks.

Well now, this tends to cause people who read these two pieces of testimony to be quite concerned about giving the voting right to these bank presidents. Whether the inferences are correct or incorrect is beside the point.

I think, in point of fact, you are raising the question of: Are these governmental officials? Never mind all the compromises that were made in order to overcome the concern about domination of the financial power in Washington in 1913, and it is quite conceivable that you would, indeed, get able men for less money, but I am not in a position to make such a judgment for partly in teaching I argue that there is a relationship between returns and productivity.

Mr. REUSS. Let me ask one final question: Let's suppose we, the Congress, adopted the overall Shapiro package here, after extensive consideration in the committee.

Mr. SHAPIRO. Long delays——

Mr. REUSS. The 12 regional Feds would become glorified check clearinghouses except for retaining an advisory function. Let's assume that the Presidents of these regional Feds should continue to get a very, very handsome salary, \$50,000 a year or more, double or triple what scientists and Cabinet officials get.

Let's suppose further that they are given a research budget which allows them to hire at top going prices a dozen crackerjack economists and a suitable complement of other staff.

And let us assume, furthermore, that they give high-level advice to the Board of Governors in Washington. They would be wise men on economic policy for their own regions, and their function would be to present this expertise to the Federal Board.

Now, I come to my question: Do you not think you would get pretty good people as candidates for those jobs?

Mr. SHAPIRO. I have not a single reservation in the world, and I deem it inappropriate to offer my services, even at substantially below \$50,000. You will have to make a judgment as to whether I am competent, but on those financial terms I suspect that you could get able people indeed.

Mr. REUSS. What do you think?

Mr. SAMUELSON. Well, my general viewpoint on salaries is one that the Board members' salaries should be very considerably increased.

If I may enter into the record somewhat frivolous writings of financial journalistics, I did speak to that issue.

I do not think that the total amount spent on salaries of the 12 Federal Reserve bank top officials is a great amount.

Now, admittedly, we should turn off the lights in the White House and in the halls of this building when they serve no useful purpose, and you will want to save money everywhere; but the consequences of a good Federal Reserve System and a bad Federal Reserve System or a very good one and less-good one are so much greater than the sums of money that we are talking about that I would leave that to a separate survey of where one could economize.

Mr. SHAPIRO. Excuse me, Paul. I would certainly concur in that and, as I understand it, by the way, the CED is looking into this whole salary question.

There is, however, one point that I would like to make just as I think one requires the compensation to get able people in the central bank I think it is equally important that we able to recruit able people in every other walk of Government enterprise, and I would not single out the central bank as a peculiar group of people who deserve more than the going rate on the assumption that at less than these rates we attract very competent people in other parts of the Government.

Mr. SAMUELSON. I think that top Government salaries are much too low for the responsibility that is exercised, with the result that very poor people or very rich people are much more available for those positions on a career basis than most of us in-between.

I have tried to——

Mr. REUSS. I agree with that. My question was whether \$50,000 a year, plus the availability of a topnotch staff of economists, is not likely to attract good people.

Mr. SAMUELSON. I think that you will get good people for those posts.

I think that the people in the past have been very good but not beyond the expected range of excellence.

My own proposal has been very modest with respect to evolution. Change as little as possible. Just correct the small things that need change.

Now, to the very notion that you turn the 12 regional banks into glorified clearinghouses, if that were the effect of Professor Shapiro's recommendation I would consider that a debit against it.

There is an honorific function that is involved there. Even austere socialistic countries, when they send ambassadors abroad, make sure that their expense accounts are adequate to the station.

Mr. REUSS. I do think you are flaying a dead horse here because there was not a suggestion that the President of this bank be the alpaca for his glorified clerk.

The suggestion was that the President of the 12 regional banks be a person of very high stature, paid at least as well as he is now and better than some of them now are, and with a staff adequate to his function. He would be a regional pro consul who came to advise Washington, just as he does now unless he happens to be a member of the Open Market Committee. Both of you gentlemen, or at least Professor Shapiro, would divest him of that.

Mr. SAMUELSON. I do not think you will save hundreds of millions of dollars though if you confine your discussion to reducing the research staffs somewhat in the regional offices.

Mr. REUSS. Well, a great part of the savings would come in amalgamating the bank-examining functions which are now spread over three agencies.

That was the essence of the Shapiro-Robertson suggestion. But I do not purport to know how much it would save.

Well, thank you very much, gentlemen, for your great help. We appreciate your appearing here, and the subcommittee now stands in recess until Tuesday morning at 10 o'clock.

(Whereupon, at 12:05 p.m., the committee was adjourned, to reconvene at 10 a.m., Tuesday, March 3, 1964.)



# THE FEDERAL RESERVE SYSTEM AFTER 50 YEARS

TUESDAY, MARCH 3, 1964

HOUSE OF REPRESENTATIVES,  
SUBCOMMITTEE ON DOMESTIC FINANCE OF THE  
COMMITTEE ON BANKING AND CURRENCY,  
*Washington, D.C.*

The subcommittee met, pursuant to recess, at 10 a.m., in room 1301, Longworth House Office Building, Hon. Wright Patman (chairman) presiding.

Present: Representatives Patman, Reuss, Vanik, Minish, Weltner, Wilson, Kilburn, Widnall, Mrs. Dwyer, Harvey, Bolton, Brock, McDade, Talcott, and Clawson.

The CHAIRMAN. The committee will please come to order. Today we are going to hear from Prof. Milton Friedman, the Paul Snowden Russell distinguished service professor of economics at the University of Chicago. Professor Friedman is perhaps today's outstanding expert in monetary economics. He is the author of many books and articles, including "A Monetary History of the United States, 1867-1960," which he wrote with Mrs. Anna Schwartz.

It is noteworthy that several of our earlier witnesses have alluded to Professor Friedman's theories and policies. Some have indicated his criticism of past Federal Reserve policies is too strong, others have said it is too weak. Some have told us his rule for conducting monetary policy is too rigid, others have said it is just what we need for a well-run economy. Now, we will have a chance to hear from Professor Friedman himself on these matters, and I know that we will all learn a great deal from his testimony.

## STATEMENT OF PROF. MILTON FRIEDMAN, UNIVERSITY OF CHICAGO, CHICAGO, ILL.

The CHAIRMAN. Professor Friedman, we are certainly glad to have you, sir. I believe you have a prepared statement, and you may proceed in your own way, sir.

Mr. FRIEDMAN. Thank you very much for those kind introductory comments, Representative Patman.

In these introductory comments, I shall discuss briefly three issues:

1. The desirability of an "independent" monetary authority.
2. The prohibition of interest payments on demand deposits.
3. Current monetary policy.

### *1. The desirability of an "independent" monetary authority*

Should there be a truly "independent" monetary authority? A fourth branch of the constitutional structure coordinate with the legislature, the executive, and the judiciary? That is the central issue

involved in judging the present organizational structure of the Federal Reserve System.

It is an issue that has recurrently been a subject of political controversy in the United States and that has been decided sometimes one way and sometimes the opposite. It was decided in the affirmative when the first Bank of the United States was established in 1791; in the negative after a bitter battle when the bank's charter was allowed to expire in 1811; again in the affirmative when the second bank was chartered in 1816; again in the negative when the second bank's charter was allowed to expire in 1836 after the bank war between Andrew Jackson and Nicholas Biddle.

The pendulum swung again in the Civil War when the National Banking System was created but that time only part way. The next 50 years saw frequent debate over the issue but no major change until the enactment of the Federal Reserve Act in 1913. That act completed the swing by establishing again an "independent" monetary authority. This time, the independent power was lodged primarily in the regional Reserve banks.

Until Benjamin Strong's death in 1928, the power was in fact exercised primarily by New York. Strong's death unleashed a struggle for power that produced a transfer from New York to the other banks, a transfer that had tragic consequences for the Nation.

The mistakes of the Reserve System in 1919-21 and the even more disastrous mistakes of 1929 to 1933 led to a swing part way back, away from independence. Though the Banking Acts of 1933 and 1935 broadened the range of monetary instruments that could be used by the System, they also transferred effective power from the banks to the Reserve Board.

In principle, the Board is independent, and, in practice, it has displayed some measure of independence. Yet it is clearly subject, far more than the banks were, to political pressure, direct and indirect. It is hardly conceivable that the Board could today defy political pressure to anything like the extent and for anything like the length of time that the banks did in the early 1930's.

Should this residual degree of independence be increased or decreased? In an article that I am submitting herewith for your consideration and for the record, I have discussed the issues of principle involved in some detail. I shall therefore simply state my major conclusions:

(1) Proponents of an independent monetary authority seek a stable monetary structure that is free from day-to-day political pressures. This aim is eminently desirable.

(2) However, a truly "independent" monetary authority is most unlikely to achieve this aim. Experience shows that independent monetary authorities have introduced major elements of monetary instability, and analysis suggests that they can be expected to continue to do so. In addition, it is most undesirable politically to give so much power to individuals not subject to close control by the electorate.

(3) The surest way to achieve the aim of a stable monetary structure is, in my opinion, to legislate a rule specifying the behavior of the quantity of money. The rule that I favor is one which specifies that the quantity of money shall grow at a steady rate from week to week, month to month, and year to year.

2. *The prohibition of interest payments on demand deposits and control over interest rates payable on time deposits*

The prohibition of interest payments on demand deposits, enacted in the Banking Acts of 1933, for member banks, and of 1935, for other insured banks, was not then desirable and is not now. It is a straightforward example of governmental price-fixing, of a governmentally enforced price cartel. The price that a bank can explicitly pay to borrow funds from depositors is fixed at zero, and this fixed price is enforced by the Government.

The fixed price of zero serves no public purpose and runs directly counter to our general objective of fostering free markets and free enterprise.

Insofar as it serves any private purpose, that purpose is simply to inhibit competition among banks and thereby enable them to pay less than the competitive price for the funds they borrow and to earn more than the competitive rate of return on their capital.

It has always seemed to me a remarkable example of how hard it is to be objective about one's own problems that the banking community, which is so strong an advocate of free markets and free prices in almost all other respects, should believe it to be in the public interest for the Government to fix the price of the major resource purchased by the industry.

The prohibition should be repealed at once.

Similarly, the powers which the Reserve Board and the FDIC now have to control the rates of interest that commercial banks may pay on time deposits should also be repealed. They have no more justification than the prohibition of interest payments on demand deposits.

3. *Current monetary policy*

I turn now to current monetary policy partly because it illustrates, in my view, the difficulties with an independent monetary policy.

The chief defect in Federal Reserve policy has been a tendency to go too far in one direction or the other, and then to be slow to recognize its mistake and correct it. Contrary to widely held views, the major mistakes of this kind in peacetime have all been in a deflationary direction (if 1919 is excluded as still part of the wartime experience):

These major mistakes include the sharp deflation enforced on the country in 1920-21; the contraction in the quantity of money by one-third from 1929 to 1933; the doubling of reserve requirements in 1936-37 and the subsequent shift from a rapidly rising to a declining quantity of money; and, most recently, the decline in the quantity of money from 1959 to 1960. That decline certainly contributed to bringing the expansion which began in 1958 to an untimely end; and may, indeed, have been the primary reason for the brevity of the expansion.

Current policy again reveals the tendency for the System to go too far, though at the moment in the opposite direction; namely, in the direction of an unduly rapid expansion in the quantity of money.

For the background of the present situation, it is perhaps desirable to start with early 1958, when the quantity of money started to rise at a rapid rate as a result of a belated but vigorous response by the Reserve System to the recession that began in mid-1957. During the rest of 1958, the quantity of money rose at a very rapid rate. The



recession, which had aroused wide concern that it would prove deep and long, ended in April 1958. The rest of 1958 was characterized by vigorous expansion.

Chart 1  
Comparison of Changes in Money and Production, 1957-1963

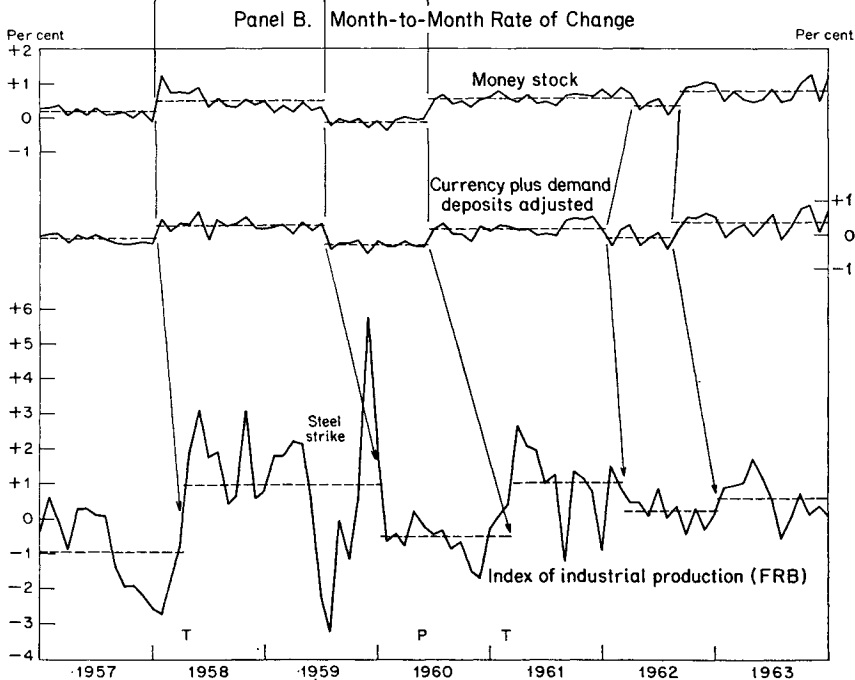
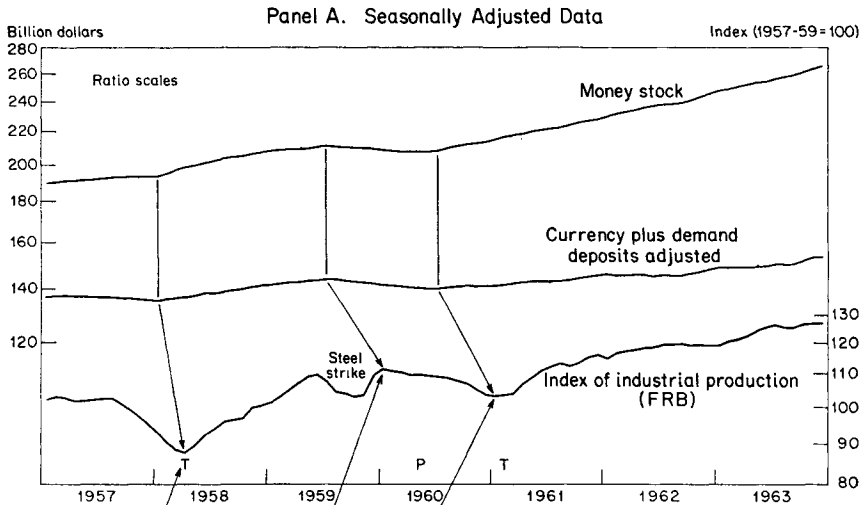

The horizontal broken lines represent high and low steps in the rate of change. T and P show reference cycle turning points.

I have here a chart which presents some of the same evidence in a visual form and which may help to bring home to us some of the particular points I am making.

The chart covers the period, as you will see, from 1957 to 1963 and shows in the top panel, at the very top, what we have called the money stock, which includes currency, demand deposits, and time deposits at commercial banks.

The next line down is what the Federal Reserve System calls the money supply, currency plus demand deposits adjusted.

The bottom curve in panel A is the index of industrial production and is some indication of what has happened to general business. You can see the episode that I am now speaking of by the sharp decline in business from 1957 to 1958, which was the recession of that year.

It is difficult to see what is happening in the series on the stock of money, because it is such a steady series with a rapid upward trend. A much better idea can be obtained from the series in the bottom panel showing month to month changes in the stock of money. The scale for the series is in percent per month. The top series in panel B is for the money stock defined to include time deposits in commercial banks. The next series is for the more narrowly defined money stock—currency plus demand deposits only.

You can see that the recession in 1957 had been preceded by a rather slow rate of growth in the money stock.

This jump in the series at the end of 1957 was the Federal Reserve Board's reaction to the recession. As you can see, the reaction came late. It came at the end of 1957, although the recession had been in progress for some time. It was followed, a few months later, by the beginning of an upturn in industrial production.

The next step is the rapid rate of increase in the quantity of money in 1958 which I was speaking of a moment ago. It was associated with or brought to an end or helped bring to an end the contraction and to launch the subsequent expansion.

In 1959 the Reserve System again reversed course, as is reflected in the sharp drop in the rate of change in the money stock. It reversed course partly because it concluded, and correctly, that it had shifted too far in an expansionary direction partly because of concern over gold losses.

Once again, unfortunately, it shifted too far, this time in a contractionary direction. The quantity of money not only ceased growing, it actually declined from July 1959 to June 1960. The rate of change was negative, as can be seen in the two top series in panel B of the chart.

The monetary decline was followed by economic recession.

As can be seen in panel A of the chart, the index of industrial production reached its peak in early 1960. The P on the bottom line of panel A marks the date that the National Bureau has designated as a reference peak. It is when they estimate that business in general reached its peak. It came on this occasion later than the peak in industrial production, and both came some months after the downward shift in the rate of change of the money stock.

In mid-1960, there was another shift, this time to a higher rate. From June 1960, the quantity of money rose at a fairly rapid rate to the end of January 1962.

The monetary expansion was followed by economic expansion beginning in early 1961. Once economic expansion was clearly underway, the System again reversed—presumably because of continued concern with gold. From January 1962 to August 1962, the money stock, defined narrowly, to include currency and demand deposits—that is, the second one of the lines in each panel—actually fell at an annual rate of about 1 percent; defined more broadly, to include commercial bank time deposits as well, it rose at a fairly rapid rate—about  $5\frac{1}{2}$  percent per year—though more slowly than in the prior year.

This discrepancy between the rates of growth of the two definitions of money is far wider than usual. It was itself produced by Federal Reserve action, raising the maximum rate of interest commercial banks could pay on time deposits.

Taken altogether, the period from 1957 to mid-1962 was characterized by unduly wide swings in the rate of growth of the money stock and also by a somewhat lower average rate of rise in the money stock than in earlier postwar years. The swings in the money stock contributed to the too-frequent ups and downs in the economy. The low rate of rise in the money stock contributed to the generally high level of unemployment but also, on the favorable side, to relative stability in wages and prices.

September 1962 saw another change of course. The change was in a desirable direction, but too great in magnitude. Since then, the quantity of money, defined narrowly, has risen at a rate of nearly  $4\frac{1}{2}$  percent a year; and defined more broadly at over 8 percent a year. These are rates of rise that cannot be long maintained without producing a substantial increase in prices.

Over the some 90 years for which we have data, the average rate of rise of the money stock, broadly defined, the top line, was about  $5\frac{1}{2}$  percent, and even this was larger than was consistent with stable prices. Prices at the end of the period were higher than at the beginning by an amount which, averaged over the nine decades, equaled a rise of 1 percent a year. Over these nine decades, there is no instance in which the stock of money, broadly defined, grew as rapidly as in the past 15 months for as long as a year and a half without being accompanied or followed by an appreciable price rise.

It is worth noting how closely the shifts that I have listed in the rates of growth of money have been followed by changes in economic activity. Each time the quantity of money has risen at a more rapid rate, economic activity has some months later accelerated, and conversely.

That is the connection I have been pointing out on the chart where it comes out very clearly.

The connection is particularly close and impressive in the current expansion. A faster rate of growth in the quantity of money beginning in mid-1960 was followed by the end of the recession in early 1961 and a rather rapid recovery during the rest of the year.

The slowing down in the rate of growth of the quantity of money in early 1962 was followed a few months later by a slowing down in the rate of recovery that caused so much concern and that produced a level of income for the year 1962 appreciably below the early forecasts of the Council of Economic Advisers.

The increase in the rate of growth of the quantity of money in September 1962 was followed around January or February 1963 by an acceleration in economic activity and a rapid growth in income despite the absence of the tax cut that had been advertised as a *sine qua non* of continued recovery.

Why has the Reserve System been so erratic? Why has it shifted back and forth and tended to go too far in each direction?

There are, I believe, two main reasons. The first is the use by the Reserve System of the wrong criterion of policy. The Reserve System, and so also most people who discuss monetary policy, tend to state the objectives of policy in terms of what are called money market conditions. The most popular current variant stresses interest rates and judges performance by the behavior of interest rates.

Other variants stress availability of credit, free reserves, borrowings by banks, and the like. Now, the fact is that the Reserve System is only one of many forces affecting credit conditions; it can affect interest rates only to a limited extent; and it can do even that only by giving up control over the quantity of money.

On the other hand, the Reserve System can, if it wishes to, control the quantity of money. By altering the volume of reserves available for banks to hold, it can determine the quantity of money within very narrow limits and with very brief delay. No other agency in the economy can exercise anything like a corresponding degree of control over the quantity of money. The behavior of the quantity of money should be the primary criterion of monetary policy.

The second reason why the Reserve System has tended to go too far in its swings is because of the time it takes for its actions to have effects. The effects of monetary expansion occur only several months, and sometimes many months, after the expansion. The result is to blur the connection and to lead to overreaction when the effects finally become manifest. At the present moment, for example, there is already built into the economy considerable monetary steam.

If the Reserve System waits until the inflationary effects of its present policies become clearly manifest and only then curtails the rate of monetary expansion, it will be months thereafter or perhaps a year or more before the inflation is stemmed. In the interim, it will understandably be tempted to step on the brake too hard.

This delay is very clearly seen in the chart which shows how each of the shifts in the rate of change of the money stock has been followed some months later by the corresponding movements in economic activity.

To summarize briefly this discussion of current policy: the Reserve System moved in the right direction when it speeded up the rate of growth of the quantity of money in mid-1962, but it went too far; it has since then produced a faster rise in the quantity of money than can be maintained for long; the danger is that when this becomes painfully apparent, the Reserve System will again, as so often in the past, swing too far in the opposite direction and force unnecessary deflation on the country; if this outcome is to be avoided, it is essential that the System promptly moderate the rate of growth in the stock of money and shift to a rate that it can maintain indefinitely.

Finally, the major requisite for a continuing improvement in monetary policy under the present organizational structure is that the System use the quantity of money as the magnitude in terms of which it

states its proximate objectives, and adapt its day-to-day instruments of policy to control the quantity of money in accordance with stated objectives. It should permit interest rates to adjust in the light of market forces to whatever levels are consistent with the resulting quantity of money.

Thank you.

The CHAIRMAN. Thank you, Dr. Friedman.

Mr. REUSS, would you like to question Dr. Friedman?

Mr. REUSS. Thank you, Mr. Chairman.

Welcome, Mr. Friedman. When you speak of the ability of the central bank to control the money supply, they do that, do they not, by making available bank reserves and deposits which are the crucial part of the money supply here, but are only created if businessmen and others utilize that lending capacity of the banks? Is that not so?

In a time of real depression, the monetary authorities can create tremendous bank lending powers through increasing reserves, yet the money supply may not be much increased if businessmen are absolutely hopeless and do not borrow money at any price. Is that not so?

Mr. FRIEDMAN. I do not believe so. It has often been alleged to be true and one can conceive of a kind of world in which it would be true. However, in the course of many years of American history it has never been true, so far as I can judge from the evidence.

The fact of the matter has always been that if banks get additional reserves they can, at their own volition, use those to increase the monetary supply. If businesses were not willing to borrow, which again has, so far as I know, never been the case, then banks can buy investments.

They can buy Government securities, State and local securities, and so on.

Mr. REUSS. And in either case there is an addition to the money supply?

Mr. FRIEDMAN. There is an addition to the money supply. To the best of my knowledge, as I say, there is no case in at least the 90 years of American history for which I have examined the evidence in detail in which the situation you describe has existed.

Mr. REUSS. Fine. You have answered that question very clearly.

You believe that this country would be better off if Congress simply legislated a rule of conduct for the monetary authorities which said, "Increase the money supply defined, as currency outside banks and time and demand deposits at the annual rate of 4 percent a year"? You say 3 to 5 percent.

Mr. FRIEDMAN. The percentage I have used has been for the broader concept of the money supply. On the experience of the past 90 years you would want to use a slightly smaller percentage for the narrower concept you referred to.

Mr. REUSS. You suggest in your article some number between 3 and 5 percent for the narrower——

Mr. FRIEDMAN. No, I believe it is for the broadly defined monetary stock.

Mr. REUSS. Well, you say, "For this purpose I have defined the stock of money as including currency outside commercial banks plus all deposits of commercial banks.

"I would specify that this should rise by  $x$  percent or some number between 3 and 5"——

That is the narrow definition?

Mr. FRIEDMAN. No. It is the broader of the two which I referred to in my testimony and which are depicted on the chart.

There are still broader definitions that one can use, but the broader of these two precisely corresponds to what you mentioned.

It includes both demand deposits of commercial banks and time deposits of commercial banks, whereas the narrower definition would include only the demand deposits of commercial banks.

Mr. REUSS. I see.

Mr. FRIEDMAN. Now, you can have still broader definitions by including the time deposits of mutual savings banks, mutual savings and loan associations, and so on.

Mr. REUSS. Do you ever recommend a percentage increase for the narrower definition just including currency outside banks and—

Mr. FRIEDMAN. Yes, 3 to 5 is about right for the broader definition.

Somewhere between 2 and 4 is about right for the narrow definition.

Mr. REUSS. Now, which of the two would you select if we were writing the statute here?

Would you take the broader or the narrower or an average of both?

Mr. FRIEDMAN. I would take the broader subject to the proviso that the present control over rates of interest on both demand deposits and time deposits is eliminated. The control of the rate of interest has been a major source of erratic shifts between the totals defined by the two definitions.

Mr. REUSS. We had a recent example of that within the last 2 years when the Fed allowed a higher rate of interest on time deposits, and then at a time when they had been, as they frequently do, creating very niggardly inadequate additions to the money supply, and they pointed to the broader definition and said, "Look, we have been creating money like a drunken sailor here.

"Look at the way the money supply, broadly defined, has moved up."

Mr. FRIEDMAN. That is this difference right here on the chart at the beginning of 1960.

Mr. REUSS. But this would be an illusory way of looking at it, would it not?

Mr. FRIEDMAN. Right.

Mr. REUSS. Further, with this model statute we are constructing, I will recapitulate as follows: Congress says to the Fed make additions to the money supply at an annual rate of 4 percent, "money" being defined as currency outside banks and both time and demand deposits.

What instruments of monetary policy would you let the Fed use? Certainly, open market policy?

Mr. FRIEDMAN. Yes.

Mr. REUSS. Would you keep the rediscount window open?

Mr. FRIEDMAN. There are different levels on which one can discuss this.

My own preference, if you really were altering the powers as well as the rule, would be to eliminate discounting completely.

Mr. REUSS. But let banks borrow where they can?

Mr. FRIEDMAN. Right, and have open market operations. I would also eliminate the ability to change reserve requirements so that I

would leave the Fed with the one tool which is the most potent they have; namely, open market operations.

Mr. REUSS. If we do that, and I approach this with an open mind and I am certainly not saying we should not, we can then save some money on salaries of the Board of Governors and we can get a computer to do all this?

Mr. FRIEDMAN. Under present circumstances, we do need a computer, because there is a sizable slip between the open market operation and the final money supply, first because part of the total money stock is held as currency and the public may change the proportion in which it wants to hold currency and deposits and, secondly because the banks may change the ratio of reserves they want to hold.

Mr. REUSS. You could give us the program for that computer so that—

Mr. FRIEDMAN. Well, the Federal Reserve now could give that program to you very well and much better than I can.

They have such a program, of course. And, do not misunderstand me, I think the Federal Reserve would operate such a program very well. I think they are very good at these kinds of technical operations. The problem is not their technical capacity but what rule they follow, what criterion they use.

Mr. REUSS. Back to your percentage again, should it be 3, 4, or 5? Have you considered anything like a formula-timing arrangement such as stock market operators use, whereby you could relate that percentage to such things as unemployment, degree of unused industrial capacity, so that in a year or a month or a week, at which we were running at 6 percent unemployed and 15 percent of the industrial capacity unused, maybe that week the money supply ought to be increased at a rate of 5 percent, whereas in a week when we get closer to capacity you ought to go down to 3 percent? Would that not be feasible? Is there anything wrong with considering that?

Mr. FRIEDMAN. There is obviously nothing wrong with considering it and, of course, it is feasible to have such a formula, but I do not think it is desirable at the present state of our knowledge.

The reason it is not desirable is because I do not think we could have reasonable confidence that such a formula would do good rather than harm.

The reason at the moment we cannot have such confidence is precisely the point I have emphasized earlier; namely, the time which it takes for monetary changes to have their effect.

We cannot even measure what unemployment is now. We can measure only what unemployment was a month or more back. More important, what we do now will affect not the unemployment of today or 3 months ago, but maybe the unemployment of 5 months from now or 6 months from now or a year from now.

So, in point of fact, I do not believe that we know enough now to set up a formula of this kind which would do more good than harm.

Mr. REUSS. Strangely enough, I have more fears about your ingenious proposal on the inflationary side than I do on the deflationary side. Strangely enough, you know what side I am worried about.

That is so for this reason. If you set your percentage figure of money increase each year at, say, 5 percent, I would really have no fears about it being inadequate. In years of terrible depression—God

forbid we have them—there still probably would be enough money available to get the economy moving forward, because banks could sell their earning assets to make loans any time anybody really wanted them.

However, on the inflationary side, if you speak in terms of the Continent of Europe, of the full employment of men and factories, I tend to shy away a bit from creating 4 percent additions to the money supply in the year.

I will let you get by without putting an accelerator on this, but could you not put a brake on it?

Mr. FRIEDMAN. I think it would be very undesirable to do so. In point of fact, I personally do not know of any inflationary episode in any country in which the money supply has increased as little as 4 or 5 percent a year.

The only way, I believe, that you could get the kind of dangerous inflationary conditions that you are conceiving of would be by having a more rapid rate of increase in the money supply than would be specified in the rule.

This is certainly true of American experience. I have not examined equally carefully the experience of all other countries, but I do not know offhand of any example in which there has been substantial inflation without a substantial rate of rise in the money supply, by which I mean a rise of more than 4 or 5 percent a year.

Mr. REUSS. So your answer to my question would be, in the first place, you think the Friedman type of formula would prevent the overflow of employment which raises this problem in the first place.

Secondly, if you should prove to be wrong, you would be the first man to come in here and confess error and say change the law tomorrow so as to put on this brake—

Mr. FRIEDMAN. Yes.

Mr. REUSS (continuing). Which could be done in a great hurry, could it not?

Mr. FRIEDMAN. Yes; it could; and I think it would.

And I may say, on this score, Mr. Reuss, I prefer very much the rule over alternatives that I know, but as between two other alternatives, which is congressional control of monetary supply and central bank control of monetary policy, I would personally prefer to trust the Congress.

Mr. REUSS. I am deeply touched—

Mr. FRIEDMAN. I hasten to add, Mr. Reuss, that high as is my regard for the Congress and its Members, my preference for having Congress in control is not because I believe the Members of Congress are personally able or more devoted than the members of the Board.

I think the members of the Board and the System are devoted public servants and able people. That is also true of Members of the Congress, and I do not mean to make a distinction between them. The difference is in the pressures under which they operate. It is a natural human quality of every one of us that the hardest thing in the world is to do what you just generously suggested I would do, and that is to admit error.

If any one of us can possibly avoid it, we will.

If a person is a member of a board which is in a so-called independent position, so that he is not subject to being unseated at the next



election, it is very, very tempting for him, once he has made a mistake, to be slow to recognize that it is a mistake. It will have to be shown to be a real and glaring mistake before he will come to the conclusion that it was a mistake.

On the other hand, if he is a Member of Congress, he does not have that much leeway. Under circumstances when Congress is making a terrible mistake, the Congressman will hear from the voters back home.

I look at our own monetary experience and history. I am personally convinced that, in the great depression from 1929 to 1933, this country would have been far better off if the Congress had been followed than it was with the Reserve System sitting in the saddle.

If you read the records of the Reserve System, what do you find? You find that after an initial mistake everybody's opinions congeal. "Oh, it is not our fault. Other people are responsible and we have to maintain our position."

Why did the System ever engage in the open market operation of 1932 which was the one occasion, during the depression, in which it engaged in large-scale expansionary action? Under threat of a congressional investigation.

The open market operation was ended a week or 2 weeks after Congress adjourned.

So I think that the record is very clear that our performance in the 1930's in the monetary area would have been very much better if Congress had had control over it than the way it was.

Mr. REUSS. Thank you.

The CHAIRMAN. Mr. Widnall?

Mr. WIDNALL. Thank you, Mr. Chairman.

Professor Friedman, you have offered some very interesting testimony and certainly some stimulating thought.

In studying the Federal Reserve System and its actions through the period of years have you, in any way, contrasted that with the action of foreign central banks during the same period?

Mr. FRIEDMAN. Only to a very limited extent, Mr. Widnall. I know, of course, of the actions of the Bank of England during the 1920's and the Bank of France during that same period, because that was the period in which our central bank, the Bank of England and the Bank of France, were working very closely together in cooperation.

I am not sure what phases of their operation you would like me to comment on.

Mr. WIDNALL. Well, I am thinking right now: The Bank of England has just raised the rate from 4 to 5 percent.

If you were advising the Bank of England, the central bank, do you think they are operating in a correct way to meet the changes of economy over there?

Mr. FRIEDMAN. I have not followed in detail the current circumstances of the British economy, so I cannot answer the question about this particular rise.

In general, of course, the situation of England and the situation of the United States have one very important point of difference, and that is that foreign trade is much more important to Britain than to the United States. Hence, monetary policy in Britain, under present international arrangements, namely with fixed rates of exchange, has

to be much more sensitive, to adapt much more rapidly to its international financial position than does the monetary policy in the United States.

Mr. WIDNALL. Is not one of the most important things we are facing today our balance-of-payments situation and does not that involve foreign trade?

Mr. FRIEDMAN. Yes, indeed, it is.

Mr. WIDNALL. So that the action of the Federal Reserve cannot be taken just predicated on what is happening in the domestic economy. It also must relate itself to the entire world?

Mr. FRIEDMAN. Unfortunately, you are right. That is because we are following what, in my view, is a most undesirable policy with respect to our balance of payments.

As I have testified before the Joint Economic Committee, I personally am in favor of a free market solution to the problem of the balance of payments by setting exchange rates free to fluctuate and to be determined in the open market. That would make it possible to have a domestic monetary policy that does not have to be wagged by the 5-percent tail of our economy which consists of foreign trade.

Mr. WIDNALL. On page 5 of your testimony you said:

The swings in the money stock contributed to the too frequent ups and downs in the economy. The low rate of rise in the money stock contributed to the generally high level of unemployment but also, on the favorable side, to relative stability in wages and prices.

Now, do you think that a change in the money stock would have helped those who do not have the skills in today's unemployed?

Do you think it would help those who are frozen out of employment because of age today?

Mr. FRIEDMAN. Well, obviously—

Mr. WIDNALL. Federal reserves have nothing to do with those—

Mr. FRIEDMAN. I would like to emphasize that, while the money stock and monetary policy are extremely important, they are not everything, by any manner of means.

What determines the real wealth of the Nation is not its monetary institutions or policy. What determines the wealth of a nation are the qualities and capacities of the human beings, of the kind that you have been referring to, the kind of economic system under which we operate, the resources we have available, and so on.

Monetary policy operates mainly to affect, on the one hand, the level of prices and, on the other hand, the fluctuations.

If you had not had the sharp decline in the rate of growth of money from 1959 to 1960 I believe that the 1958-60 expansion would have continued for a longer period.

I believe that that would have meant more jobs for people, including the people who are low in skill and including the people who are at advanced ages.

The circumstances under which a man of 60 can get a job depend on the general buoyancy of the market. In a boom, at a time when there are many job opportunities, he will get a job more easily than at the time of a recession.

So I think the answer I would make is, "Yes." A more stable, steady monetary policy during that period would have meant that fewer people would have been unemployed and among them would have been some of the people you mentioned.

Mr. WIDNALL. Does not Government action in many other fields affect unemployment, for instance, that you cannot go out and earn anything over a certain amount if you are on social security, yet social security may not support you and your family?

Has not the fact that today many people do not want part-time jobs contributed to moonlighting and if the person who is unemployed wants a full-time job they cannot get people for part-time jobs, so the people who work all week take part-time jobs over the weekend?

Now, part of this has been frozen in by Government action.

Mr. FRIEDMAN. Of course, I quite agree.

I think a considerable fraction of our present unemployment may well be attributable to Government action in other fields. I am only speaking about monetary policy and monetary policy is not a panacea that will cure everything, and we must not suppose it to be that.

Mr. WIDNALL. Well, what I was just trying to get at is this: I took it from your statement that you were emphasizing that the Federal Reserve had a great deal to do with the high rate of unemployment continuing through the years.

What I was trying to point out is that they may have had something to do with it but there were many, many other factors involved in it that contributed to it that they had no control over.

Mr. FRIEDMAN. That is entirely right and, as I say, in that same statement, their policy contributed to the generally high level of unemployment but also, on the favorable side, to relative stability and wages and prices.

So that there are two sides to the picture. In addition, I quite agree that there are many other factors that affect the level of unemployment.

Mr. WIDNALL. Professor Friedman, to go back to page 2 you said:

Even more disastrous mistakes of 1929 to 1933 led to a swing part way back, away from independence.

As I recall it, during that period the Secretary of the Treasury had an active role with respect to Federal Reserve decisions. Is that not so?

Was not he part of the setup at that time?

Mr. FRIEDMAN. He was an ex officio member of the Federal Reserve Board but at that period Federal Reserve policy in the United States was being determined by the Federal Reserve banks and not by the Board. The fact of the matter is that, during the period you were speaking of 1929 to 1933, the Under Secretary of the Treasury, Ogden Mills, was one of the few voices in Washington that was consistently taking what I, in retrospect, regard as a sensible position at that time.

Ogden Mills was consistently in favor of the Federal Reserve following a more expansionary policy.

After 1930, late 1930, when Eugene Meyer became Chairman of the Federal Reserve Board, the Federal Reserve Board as a whole, consistently along with the New York bank, was in favor of an expansionary policy and the Board plus the New York bank were overruled by the outlying banks: Chicago, Boston, Philadelphia and so on.

So that while you are quite right, that the Secretary of the Treasury was a member of the Board, you are, if I may say so, viewing that situation in the light of the present powers of the Board and not in light of the fact that as of that time effective power was being exercised by the Federal Reserve banks and not the Board.

Mr. WIDNALL. It is not clear to me what you mean, as you read further on that same page, where you say:

Though the banking acts of 1933 and 1935 broadened the range of monetary instruments that could be used by the System, they also transferred effective power from the banks to the Reserve Board.

In principle, the Board is independent and, in practice, it has displayed some measure of independence.

Yet it is clearly subject, far more than the banks were, to political pressure, direct and indirect.

Now, I understood the purposes of these hearings, in evaluating the 50 years of the Federal Reserve System, were to also consider a bill that would place the Federal Reserve System in an operation where they would be directly subject to political pressure.

Have you any comments to make on the pending bill which would change the composition of the Federal Reserve Board?

Mr. FRIEDMAN. Well, now, let me comment not on the details of that bill but on the general aim.

In my view it would be desirable to make it clear and explicit that the Board and the Reserve System are subject to direct political control by the administration and the Congress. In my view, the present pseudoindependence is not a real independence and is, as in the past, likely to do harm rather than good.

As to the specific measures which are taken to achieve this object, I do not myself feel competent to judge those in detail. What I am trying to do in those sentences, Mr. Widnall, is to separate the substance of what is really the case from the mere form.

In practice, the most important thing that was involved in the Banking Act of 1933 to 1935 was shifting the focus of power from a dozen cities spread around the country to Washington.

The Board in Washington is very much subject to a kind of political pressure which the banks spread around the country are not. In addition, the Board in Washington, the members of it are appointed by the President. They are directly connected with the political activities in the Capitol.

They are sensitive to the currents of opinion. It is literally incredible to me that our present Board could maintain a policy as much in variance with the policy desired by Congress as the System maintained from 1932 to 1933. I just do not believe that this would be conceivable.

And I wonder, Mr. Widnall, whether you think it would be conceivable to have such a situation?

Mr. WIDNALL. I think the present system is working pretty well, and I would differ with you in my own analysis of the situation. I just do not see the consistency of your saying that this present setup is far more subject to political pressures direct and indirect, when the charge is made day after day about the Federal Reserve System, that they are not responsive to the President or to the administration.

It does not seem to go together.

Mr. FRIEDMAN. The question is: Should this residual independence be increased or decreased?

The Board does have a measure of independence. The question is does it still have too much or too little and, in my own view, it still has too much.

Mr. WIDNALL. That is all for the time being. Thank you.

The CHAIRMAN. Mr. Vanik?

Mr. VANIK. I just have a couple of questions here.

Your statement deals broadly with the relationship of money supply in prosperity. Now, is it your theory that the rising interest rates are brought about by the inadequate money supply? That seems to be the substance of it, is it not?

Mr. FRIEDMAN. No.

Mr. VANIK. Well, I misunderstood you then.

Mr. FRIEDMAN. I am sorry. I am undoubtedly responsible for the misunderstanding.

I have tried to emphasize that interest rates are largely determined by a wide range of forces of which the quantity of money is only one.

The Federal Reserve System, or any other central bank, cannot determine the structure of interest rates. At most, it can manipulate a small corner of it a little bit.

The fact is that rising business, increasing income, expansion, tends to bring about, in general, rising interest rates and not the other way around.

Mr. VANIK. Well, you then believe in this doctrine of the free marketplace for the financing of home level and where everybody has to accommodate themselves to that situation.

Is that not about it?

Mr. FRIEDMAN. There is no alternative—

Mr. VANIK. There are some alternatives now. Is there not another way to stabilize interest rates simply by the establishment of national usury laws?

There seems to be a little morality in the past in which usually it was a violation of the law. And this is not price control. It is a matter of putting a ceiling on what money can bring from those people who have to pay for the use of it.

It goes to our very heritage. It is fundamental in our law and why is it that that approach cannot have some place in this discussion?

Mr. FRIEDMAN. Mr. Vanik, I believe that that is price control. I find it hard to know how else you would define "price control."

Mr. VANIK. It is a ceiling—

Mr. FRIEDMAN. Yes, indeed—

Mr. VANIK (continuing). But it has its roots in morality.

Mr. FRIEDMAN. No.

Mr. VANIK. You think this has no foundation—

Mr. FRIEDMAN. No, I hope that Jeremy Bentham did not write in vain.

Mr. VANIK. You think there is no reason to have any ceiling limitation put on—

Mr. FRIEDMAN. None whatsoever.

Mr. VANIK. There is not any relationship between interest rates and human decency?

Mr. FRIEDMAN. There may be a relation between a market in which interest rates are free to move and human decency. You and I would be alike in wanting to promote human decency.

Where we disagree is that you believe an artificial—

Mr. VANIK. I believe we just pause in talking about human decency—

Mr. FRIEDMAN. Whereas you think that a legislative ceiling on interest rates would promote human decency I think, and I believe

there is much evidence to support this belief, that such a limit will reduce it.

To put a usury law on, which limits interest rates to a level which is below the market level, is to deny people credit who most need it.

No doubt people who urge usury laws think they are helping the borrowers. Actually, they are hurting them. What happens, when you put on a usury law in any country, is that the borrowers who most need loans are driven to get the loans at much higher rates of interest than they otherwise would have to pay by going through a black market of one kind or another.

Mr. VANIK. Does not a usury law have the effect of stabilizing the cost of money and the cost of the use of it?

Mr. FRIEDMAN. No, its only effect is to make loans unavailable.

Consider price control in general. The effect of price control, if you set the price too low, is to create a shortage. If you want to create a shortage of loanable funds, establish a ceiling on interest rates below the market, and then you will surely do it.

Mr. VANIK. There are some areas today where we fixed the price of money.

What are they?

Mr. FRIEDMAN. We have fixed the price of money by establishing a ceiling of zero—

Mr. VANIK. No, no, with respect to Federal bonds we do it in certain areas.

Would you mind enumerating those?

Mr. FRIEDMAN. In connection with the bills before this committee we have fixed a ceiling at zero on the rate of interest that commercial banks may pay on demand deposits.

Mr. VANIK. Yes.

Mr. FRIEDMAN. It is very hard for me to see that that is promoting any kind of human decency. That is just preventing depositors from getting income they otherwise would get.

We have fixed a ceiling rate on interest on time deposits.

Both of these, I think, are bad and should be repealed. We have a Federal law saying that the interest rate on Government securities shall be—what is it? Four and a quarter percent?

I think that is bad and ought to be repealed.

Mr. VANIK. You think we ought to pay more than that?

Mr. FRIEDMAN. No; I think we ought to pay less.

Mr. VANIK. How much less do you think—

Mr. FRIEDMAN. As much as we have to pay—

Mr. VANIK. If we repeal it won't we be likely to pay less?

Mr. FRIEDMAN. It will not affect how much we pay. That law has no effect on how much we pay.

It is a piece of paper—

Mr. VANIK. Well, we get around that by the discounting.

Mr. FRIEDMAN. Of course.

Mr. VANIK. Now, you assume that there is a free market and free competition in money supply.

That is the basis of the supposition on which you operate?

Mr. FRIEDMAN. No; it is not. I assume that there is a market which has a large measure of freedom, and in which undoubtedly there are interferences with freedom. I believe that this Congress and this

committee ought to be considering ways in which it can make the market freer and not ways in which it will make it less free.

Mr. VANIK. Well, I think the whole thing is concerned with the economy, the way it is going to move along and expand, without the drag that high interest rates might impose upon it. That is our basic concern right now.

Mr. FRIEDMAN. I wonder if you would mind citing the evidence that high interest rates are a drag?

Mr. VANIK. Well, I am not here answering the questions. I will put that to you.

Mr. FRIEDMAN. I do believe an assertion like this needs to be examined.

It is asserted that high interest rates are a drag—

Mr. VANIK. I think this committee, as a matter of fact, has put out a number of documents to just prove that very point, and I think the Joint Economic Committee has and they have labored very extensively to come around to that kind of a conclusion.

I am among those here who feel right now that high interest rates drag our economy and wash out the gains that might be brought about through the stimulation of the tax cut.

I think, for example, if the automobile interest rate went up and consumer purchases went up that it ought to prevent automobile purchases because people ought to realize that a great part of their purchasing money is going to be interest rate.

I think that as this word gets around consumers might back off from making purchases. If housing loans go up any higher, why, I think that it might discourage housing investments.

I can see all kinds of dangers and possibilities that can result from the uninhibited interest rates.

People who have the capital seem to want a free market and those who do not have it seem to want more competition and some assurance that the prices are going to be reasonable.

Now, I believe in this: that this creation of a surplus of anything, whether it is wheat or beef or money, will serve to depress the price providing we can insure that balance can be maintained.

Now, you advocate surplus or at least a sufficiency of the money supply but you have given us no assurance that it is going to be available through your plan or through your system, and that is any reasonable price.

Now, I think money, and this use of money, differs from anything else—this is not wheat. This is not bread. This is not meat. This is not automobiles.

This is something a little bit different.

It is a limitation on what we should—when I think about the abandonment of usury laws I feel that we have stepped a long step away from—I think we ought to review the reasons for which the usury laws were originally put on the books in most of the States.

What was the motivating factor? Was it not something that was unrelated to money supply or anything else?

And is it not worth while reviewing again?

Mr. FRIEDMAN. Let me make two comments, Mr. Vanik.

The first of those is that considering any high price or rise in price, whether it be high interest rates or anything else, we have to distinguish between two cases which are quite different in their effects.

One case is where someone artificially pushes the price up. An example is the wheat market where the Government establishes a high support price for wheat and artificially makes it high or another might be in the money market, if the Federal Reserve System or some other monetary authority restricts the money supply and in the process forces up the rate of interest. Such forced-up high prices are adverse to the economic system and very undesirable.

The second case is one in which, in a free market, the price rises because there is an increase in demand.

If people are better off and want to buy more wheat or more meat and this raises the price then such a rise in price is a good thing because it encourages production in order to meet the demand, and the same thing is true on the market for loans.

If an increased demand for loans forces up or drives up the interest rate then this is the signal that produces an expansion in the quantity of loans available and is a very good thing.

So we cannot say whether high interest rates are good or bad. We have to distinguish between high interest rates that are pushed up by some action of government or the monetary authorities and high interest rates which are a natural result of an increased demand.

The second comment I would like to make is that one of the difficulties in our discussion is the use of the word "money" in two very different senses.

In one sense, we use "money" to mean the green paper we carry around in our pockets or the deposits in the banks.

In another sense, we use "money" to mean "credit" as when we refer to the money market. Now, "money" and "credit" are not the same thing. Monetary policy ought to be concerned with the quantity of money and not with the credit market. The confusion between "money" and "credit" has a long history and has been a major source of difficulty in monetary management. Similarly, I am afraid that part of the difficulty in our discussion has been the use of the term in these two senses.

Mr. VANIK. My time has expired.

The CHAIRMAN. Yes. Mr. Harvey?

Mr. HARVEY. Mr. Friedman, in your statement you are very critical of the actions of the Federal Reserve Board, particularly from the period 1958 on. In fact, you cite several instances to indicate that those actions have been very erratic. I will call your attention to the fact that hindsight is a wonderful thing, indeed, for all of us as human beings.

I see nothing in your statement, however, which would lead me to believe that subjecting these very questions to a politically motivated administration would call for any better result whatever.

On the contrary, to me it would be the reverse. You would have the Congress reporting out accelerated public works measures in times of peak prosperity, for example, most unresponsive to the unemployment figures and demonstrated need.

So, I just cannot agree with your conclusions whatsoever. I will agree that perhaps by way of hindsight the Federal Reserve did err, but I cannot believe that either the administration or either party, being politically motivated as they would be, would come up with better results but only poorer ones.



Mr. FRIEDMAN. I do not disagree with you, Mr. Harvey. As a matter of fact, as I say in my statement, my preference is for an arrangement which would prevent such close day-to-day control and such erratic behavior on the part of either Congress or the Reserve Board.

What I would like is to have Congress enact a rule which would provide a stable basis for monetary policy and protect it alike from the arbitrary actions of either Congress or the Board.

Furthermore, I do not mean to suggest that this period was particularly erratic. I considered this period in detail because it is recent history and hence the period we are most familiar with.

As a matter of fact, if I look back over the 50 years of Federal Reserve history, I would say that their performance in this period is, on the whole, better than the average, not worse than average. Yet, even in such a period where it is better than average it has been less satisfactory than would have been achieved by a stable rule.

So far as the minor short-term movements are concerned, you may well be right that Congress would have been worse. I do not know, it might have been better or worse.

My preference for Congress derives from a different consideration. As I see it, the major problem of monetary policy is to have a system which is not subject to major mistakes. What I am convinced of, on the basis of the record, is that Congress is less likely to make a major mistake than a Reserve Board is, although it may make more minor mistakes.

You may be right that in terms of the minor fluctuations Congress would have been worse. What I am impressed with is that Congress would never have permitted the decade of the thirties to develop as it did and would not do so again in the future.

Mr. HARVEY. Thank you.

I have no further questions, Mr. Chairman.

Mr. REUSS (presiding). Mr. Minish?

Mr. MINISH. Mr. Friedman, you mentioned earlier that you feel that the interest on Government bonds is too high. Do you have any suggestion as to what you think it ought to be?

Mr. FRIEDMAN. I'm sorry, I did not mean to say the interest on Government bonds is too high. The interest on Government bonds ought to be whatever rate you have to pay in the market to get people to be willing to buy Government bonds.

Mr. MINISH. Do you have any suggestions on it?

Mr. FRIEDMAN. On the rate of interest?

Mr. MINISH. Yes.

Mr. FRIEDMAN. I am not sure I understand your question. Are you asking me what suggestions I have for Government debt management?

Mr. MINISH. Yes.

Mr. FRIEDMAN. Well, my suggestions for that are very simple. I would reduce the range of securities offered by the Treasury very much.

I would replace our present rag-bag mixture of all sorts and kinds and sizes and assortments with two kinds of securities, a short bill and a long bond, one of each.

Second, I would distribute all such securities by auction alone. I would not have prices set in advance. I would have an open auction at which the bills or the bonds were sold at whatever price was offered for them.

Mr. MINISH. Thank you.

The CHAIRMAN (presiding). Mr. Bolton?

Mr. BOLTON. Thank you, Mr. Chairman.

Professor, I, too, have enjoyed very much being here and listening to your testimony.

I notice on page 3 and in the pages that follow that you would permit banks to pay interest on demand deposits. Some of us are exceedingly interested in seeing to it that there are as many people in the banking business and the credit business of the United States as possible and to prevent an undue concentration of economic power. I wonder if you would comment on what effect the payment of interest on demand deposits would have on the size of institutions and eventual domination of the banking business by certain large institutions?

Mr. FRIEDMAN. I believe it would not have much effect in either direction on that particular problem because the fact, of course, is that commercial banks now pay interest on demand deposits in indirect ways.

By making the payment of interest open and above board, making it explicit, the people who would benefit would be largely the small depositors.

Mr. BOLTON. I wonder if you would go a little further in the indirect method?

Mr. FRIEDMAN. Oh, of course. One indirect method is the provision of services without charge. If you have a deposit in a bank and the bank clears your checks, accepts your deposits without charging you specifically for those activities, that is a way of paying interest to you in the form of services.

For example, if you consider some of our large concerns, General Motors, Ford and others, and ask them what determines the amount of deposits they hold in small banks throughout the country, they will tell you that they hold such deposits in order to compensate the banks for the services which the banks are rendering to them.

Equally, you can look at that the other way around. They are receiving interest on those deposits in the form of the services which the banks are rendering to them.

Another way in which interest is paid on deposits implicitly and indirectly is by the fact that a depositor will be in a position to get a loan more readily and at a lower rate of interest than a nondepositor.

A third way in which interest is paid on deposits is by the banks encouraging people who borrow from them to use the products of firms which keep deposits with them.

I have known and talked with treasurers of very large enterprises that keep very large deposits all over the country for no other purpose than to induce the banks with whom they have deposits to say a good word for their products to the people who are borrowing from the banks.

And I am sure that there are many other ways which I do not know of whereby banks pay such indirect interest.

Who are the people who are in the best position to get indirect interest payments of this kind?

There are those whose deposits are large enough to make it worth while to have special arrangements and who are worth dealing with.

As always, almost every time you interfere with the free market you tend to work against the interest of the ordinary fellow in the market.

Mr. BOLTON. Would you feel that the payment of interest on top of these would merely expand the leverage which the large institution has?

Mr. FRIEDMAN. Oh, no, no, you would substitute interest for many of these.

If you had interest rates some of these other things would disappear. Whenever you interfere with the market operation what do you do?

You encourage people to get around the interference or the blockage.

So I believe that a direct open payment of interest would reduce these indirect devices.

As to the size and number of banks, that is largely a question of the terms on which a license can be obtained to open a bank rather than of the payment of the interest.

Mr. BOLTON. In a subcommittee of this committee we are wrestling with the question of the services offered by banks particularly centering around computers, and the question has been asked as to whether or not a law, which would require banks to charge on an equal basis for all the services that they offer, regardless of the size, on the basis of cost or cost-plus or some other basis, would be right.

What would be your reaction to that?

Mr. FRIEDMAN. I would think that that would be a case of adding an undesirable law in order to offset the effect of another undesirable law.

It would be far better, in my view, to repeal the prohibition of the payment of interest on demand deposits. If you did that this would establish an incentive for the banks to charge for services which they render.

Mr. BOLTON. Of course, with a computer, this is not due to a law but this is due to a physical aspect which produces leverage just because of its own being and type of operation such as the freezing of accounts—

Mr. FRIEDMAN. But so far as not charging for the services, one of the reasons for that is because this offers still another way in which a bank can indirectly pay interest on deposits.

Mr. BOLTON. Referring to another part of your testimony, sir, I think you made the point that there are many things which affect the monetary market and the economy generally, particularly this was brought up I thought in your colloquy with Mr. Vanik and Mr. Reuss, and, therefore, it puzzled me to hear you recommend a steady increase in the amount of money each year because I think you would agree that the amount of money is only one of the factors which affects the economy and, therefore, under a steady legislated growth would you not feel that there was or there would be a time when this would be too little and another time when this would be too much for the economy as of that point in its development or retrogression?

Mr. FRIEDMAN. Of course, but would we know it?

The problem is that the actual variations in the quantity of money in the past, as you examine them over a long period, seem to me to have been destabilizing. They seem to me to have been bad. Now, if you look at the record—

Mr. BOLTON. I do not follow you there.

Mr. FRIEDMAN. What I am saying is, consider the actual changes that have occurred in the quantity of money. Is it true that when, in retrospect, it would have been desirable to have had a faster increase in the quantity of money, such a faster increase occurred, and when, in retrospect it would have been desirable to have a slower increase in the quantity of money, such a slower increase occurred?

The answer is "No." If you look over the record of the past what you find is that more often than not the money supply increased when it should have decreased and vice versa; that instead of changes in the money supply offsetting other forces they have themselves been another source of instability. For example, in the period covered by the chart, suppose instead of the ups and downs that you had in the rate of change of the money stock, you had had a perfectly steady movement. In retrospect, it seems clear the steady movement would have been preferable most of the time.

Mr. BOLTON. If you are only looking at it from the standpoint of the source of the money supply—

Mr. FRIEDMAN. No.

Mr. BOLTON (continuing). But those charts do not take into account any of the other factors which influenced the economy such as the international situation, such as the international financial situation, such as the general confidence of the public, et cetera.

Would you not have the same ups and downs, whether you had a steady monetary supply or not, and would you not, in effect, by a steady increase touch off just what Mr. Reuss was worrying about, which was a gradual impetus and push toward inflation?

Mr. FRIEDMAN. Quite the opposite. Undoubtedly, if you had had a steady increase in the money supply you would have had some fluctuations in economic activity, of course. We cannot solve all problems by any single solution.

What I am saying is that industrial production or economic activity, which reflects all of these forces you are speaking of, would have fluctuated less if the money supply had increased at a steady rate than it actually did. Why?

Because the changes in the rate of growth of the money supply came at the wrong time and were in the wrong direction. For example, in early 1960, monetary growth was sharply contracted when it should have been maintained at a relatively steady rate.

Is there any body here who would not agree that we would have been better off during this time to have had a slightly easier money policy?

Mr. BOLTON. I do not know, sir, because I do not remember in sufficient detail the other factors which were affecting it, among them, if nothing else, the psychology of the business community.

Mr. FRIEDMAN. But, you see, Mr. Bolton, I think we are saying the same thing. We are really in agreement.

What you are saying is, consider this period of early 1960. That is a period when some other forces were maybe producing a decline. Then we should have tried to offset those other forces by a more rapid increase in the money supply.

I agree, if we had known it. What did we do? We intensified the other forces by a slower increase.

Consider another period when we were having a rapid expansion, say late 1958. What are you saying? The monetary authorities

should have been holding it down. They were not. Instead they were boosting it.

And so what we observe, if we look at the record, is that, in fact, instead of using monetary fluctuations as a balance wheel, instead of using them to offset other forces, we have used them to intensify other forces.

Why have we done this? We have done this because we simply do not know enough, we are not smart enough, we have not analyzed sufficiently and understood sufficiently the operation of the world so we know how to use monetary policy as a balance wheel.

Therefore, what I am saying is that the first step we ought to take is to convert monetary policy from being a destabilizing force into at least being a neutral factor.

Mr. BOLTON. Thank you, sir.

My time has expired, Mr. Chairman.

The CHAIRMAN. Yes. Mr. Weltner?

Mr. WELTNER. Thank you, Mr. Chairman.

Professor Friedman, you said that there are two main reasons why the Federal Reserve System has been erratic. One, I believe, you state is because it stresses the wrong thing.

You say it should stress the quantity of money and not the interest rates. Then, secondly, you state that adjustments in the quantity of money take their effect only over a period of several months. Although the quantity can be increased or contracted within a very short time, the effect of that is a long-range proposition.

Now, if the answer to our monetary problem is by stressing the quantity of money, how is it that we are going to solve the problem that you set forth as your second main complaint against the Reserve System, to wit, that the effect of monetary expansion is not of immediate effect but one which has caused substantial difficulties in regulation.

Mr. FRIEDMAN. Not by that step alone; that is to say, that the problem of the lag in reaction and the fact that the effects are spread over a period is not a problem that can be solved by just looking at the quantity of money.

In order to solve that problem or in order to eliminate that difficulty it would be necessary to forecast what is going to happen much better than we now can.

The Federal Reserve Chairman, Mr. Martin, has often used the phrase that the Federal Reserve System should lean against the wind, and that is what Mr. Bolton was arguing a moment ago.

The fact is that the wind he should lean against is next year's wind, and it is hard now to know which way the wind is going to be blowing a year from now.

So I do not think that, under present circumstances, there is any way that I know of fully to eliminate the effect of the lag. That is one of the reasons why I am in favor of trying to have a steady policy which does not require trying to do the forecasting which we cannot do; that we ought to adjust our behavior to the present state of our knowledge and to have some humility about what we know and what we do not know.

Mr. WELTNER. Would you go so far as to say that the Federal Reserve System is incompetent to adjust against the difficulties created by the lag?

Mr. FRIEDMAN. Yes, indeed, but this is not because of incompetency of any particular people at the Federal Reserve. I would say that economic science today is incompetent to do it.

I am not making any criticisms of particular people. I am saying that in the present state of our knowledge—my knowledge, your knowledge, the knowledge that economists in general have—we simply do not know enough to be able to know what way the wind is going to blow next year sufficiently to be able to adjust to it.

Mr. WELTNER. You feel that we can control the volume and the direction of the wind itself by a stated rule concerning the expansion of money supply? Is that right?

Mr. FRIEDMAN. The analogy is, I am afraid, getting us involved in knots.

The winds that we are speaking of are the kind of other forces that Mr. Bolton was talking about, international forces, changes in profitability in different industries, changes in the supply of goods.

There are those winds. In addition, by its changes in the money supply the Federal Reserve is creating another wind which might either counter the others or reinforce the others. What I have been saying is that in practice the Federal Reserve's wind has been reinforcing the others rather than countering them.

It has been going with them rather than against them most of the time. We do not at the present time know how to make it counter them.

Mr. WELTNER. Thank you.

The CHAIRMAN. Mr. Brock?

Mr. BROCK. Professor Friedman, following the point raised by Mr. Bolton—following that point up—when you have a period of inflationary depression it could exist with our current situation, 6 percent unemployed and 15 percent unused industrial capacity, could it not?

Mr. FRIEDMAN. The reason why I am hesitating is because any short answer to that question is going to be misleading. There is a sense in which it could.

But there is another sense in which I think it could not.

Mr. BROCK. Well, what I am getting at is, the inflationary pressures could be caused, for example, by the inordinate ability of some segment of the economy to force prices up; for example, monopolistic powers by management—

Mr. FRIEDMAN. I do not believe so. The only case I know of which remotely can be described in those terms is 1933-37. It is hypothetically possible that you could have the kind of a world in which some groups could force up prices and produce either unemployment or inflation. I do not think, as a factual matter, that is a correct description of the American economy at any time except, as I said, during the early New Deal period when NRA, trade union legislation, and so on, did produce something of an autonomous cost push.

The rest of the time I think you would have to say that inflationary pressure is a consequence of unduly rapid rates of rise in the money supply.

Mr. BROCK. We had Professor Brunner and Professor Brownlee here, who related the state of the economy solely to interest rates.

Is this your approach? I mean, are you trying, without saying so, or are you saying that interest rates are the predominant—

Mr. FRIEDMAN. No, I do not believe so. I would not want to comment on what they did say without seeing their full papers. Speaking only for myself, I think that the state of the economy depends on many things.

So far as price inflation is concerned, the immediate proximate source of price inflation is almost always, so far as I know, an unduly rapid increase in the quantity of money. This is true not only for the United States but for every other country. I know of no exception.

I know of no case on the record where you have had price inflation without monetary expansion at a rapid rate.

Mr. BROCK. Could I say this then, in summary of what you are proposing: It is that we have a number of variables and your approach would be just to eliminate possibly one of the variables?

Mr. FRIEDMAN. That is quite right, in monetary policy. I might have suggestions on other areas of economic policy.

Mr. BROCK. That is right.

Mr. FRIEDMAN. But monetary policy has one thing that it really controls, and that is the quantity of money. Our question is, How should we make it behave?

Mr. BROCK. I am not quite sure I am clear on what would happen to the money stock in some cases of your proposal.

Let's say that we had a standard increase of 4 percent in the money stock. This is the larger approach with the time deposits included. Now, if we had a period of expansion with this fixed input of 4 percent, how would you control the demand for money which would cause the expansion?

In other words, you would have in a period of expansion a greater demand, obviously, for money; and people would go down to the banks and deposit their money because the banks would be seeking more funds, and they would raise their rates of interest on demand deposits and on time deposits, and this would increase the money supply.

What would be the reaction to that?

Mr. FRIEDMAN. No, this would not increase the money supply.

Where do people get the money which they deposit? They get it by somebody transferring it to them.

Perhaps the easiest way to think of this is to think in terms not of deposits but, for the moment, these pieces of paper [indicating]. Suppose there are a fixed number of these bills around. Then each individual separately thinks he can determine how much he has, but all people together cannot.

The only way I can get more is by somebody transferring it to me. Well, that is exactly the same situation in time of expansion or of contraction.

If the Reserve System controls the total amounts of money there is—

Mr. BROCK. There is a great deal of difference in the velocity with which that changes hands?

Mr. FRIEDMAN. That has to do with the ratio of the income to the money stock. There are some differences in velocity. Over ordinary periods there is not a great deal of difference, however.

Velocity is relatively stable except for great disturbances. In a period like 1929-33, when the Reserve System permitted a third of

the money supply in the United States to be destroyed, then there was a very sharp change in velocity.

It went down very sharply and reinforced the effect of the decline in the quantity of money. If you had a big inflation there would be a sharp change in velocity. It would increase and again reinforce the effect of the increase in the quantity of money.

But if you keep the money supply fairly steady, the historical records suggest that the changes in velocity are rather moderate.

Mr. BROCK. Could we take the current situation? You have mentioned the tremendous increase in the money supply in the last 15 to 18 months.

What would be your reaction to the current situation? What should we do?

Mr. FRIEDMAN. The Federal Reserve Board, in my view, should immediately shift to a lower rate of increase in the stock of money and that can be sustained indefinitely.

Mr. BROCK. Through its open market operations?

Mr. FRIEDMAN. Through its open market operations it should shift to a point at which the quantity of money is increasing at something like 4 percent a year and hold it there. If it does not do that; if it keeps on increasing the quantity of money as rapidly as in the past 15 months, it is going to have to take another one of these steps which will go too far and force deflation on the economy.

What I am urging is a policy of trying to have a moderate, steady, stable policy that you can live with indefinitely instead of having a world in which you go from one side to the other each time thinking you are going to offset something that is going on, but in practice, more often than not intensifying it.

Mr. BROCK. I am looking at your chart. As you say that, I am looking at your chart and looking at the period from May 1957—or the year, actually, of 1958—where you had a fairly rapid decrease in the index of industrial production.

At the same time the Federal Reserve obviously or, at least the way I read your chart, was taking steps to correct it. The money stocks were going up.

They reduced the rate. Some action was being taken. Is that correct?

Mr. FRIEDMAN. Well, that depends on how you interpret this period. You see, this little bump over here is another one of those consequences of the change in the rate of interest that could be paid on time deposits.

Mr. BROCK. That occurred right about at the low point of the recession?

Mr. FRIEDMAN. As you will see, there is at this period a sizable difference between the behavior of the rate of change of the broader total of money and the narrower total because of the immediate rush into time deposits which then tapered off.

If you correct for this, I would say that during 1958 to the middle of 1959 the Federal Reserve was rather feeding the expansion.

And that was all right. It should have been, but not quite at such a high rate. What I am saying that suppose it had been between these two and it just held that steady—

Mr. BROCK. Well, the rate is almost zero or somewhere between zero and 1 percent, which is less than the figure that you recommend—



Mr. FRIEDMAN. No, I am sorry, but these percents are per months and they need to be multiplied by 12. That is perhaps a defect of the chart. So, you see, this 1 on the chart is 12 percent per year and this minus 1 is minus 12 percent per year.

Mr. BROCK. But you would try to have as the index of industrial production is going up too fast, you would have the other one going down. Is that correct?

Mr. FRIEDMAN. No, I would not.

Mr. BROCK. No, I see. Then under our current situation before we adopted the fixed rate of, say 4 percent—I mean, this is what you would say the Fed should have done if they had exercised foresight?

Mr. FRIEDMAN. In a sense, yes, that is right. What I am going on to say is I do not believe the Fed could have exercised that kind of foresight. If I had been at the Fed I would have been urging them not to try to second-guess these things.

I would urge instead to keep the policy at a level at which it can be maintained indefinitely and at which it does not do any harm. This is really what it seems to me is the lesson of experience.

Mr. BROCK. Fine. Can we get to the specific bills then?

Mr. FRIEDMAN. Surely.

Mr. BROCK. Without passing a fixed rate of growth in the money stock as you propose, should we pass the bills that are before us, to fix a maximum up of  $4\frac{1}{2}$  or  $4\frac{1}{4}$  percent on the yield of Government bonds?

Should we pass those too?

Mr. FRIEDMAN. Let's separate them then. I would not like to judge or to argue about the precise details of the first bill, but I think a bill which would place the Federal Reserve under the direct control of the administration and the Congress would be a good thing, a bill which would reduce its degree of independence.

Mr. BROCK. May I follow that up just for a second?

At this period, when we have had this very large increase in money supply and there are inflationary pressures and the administration obviously would not take a restrictive policy at this time, would this still be true because with the tax cut and the debts we envision over the year, would you still say that we should have it under the Secretary of the Treasury?

Mr. FRIEDMAN. Yes, indeed, because I fear that the Federal Reserve may not take the restrictive action until it is too late, and until it overdoes it.

I think the Treasury is at least as likely to take what you call restrictive action at any earlier date. Maybe it is not.

Again I really do not want to try to second-guess individual episodes. I am trying to look at the structure as a whole.

You are now considering a bill, not in terms of what it will do in the year 1964, but in the decades ahead. What I am saying is that if you look at a long stretch of experience, I think that you will join me in the conclusion that major mistakes are less likely if the Reserve System and the monetary authorities are more closely controlled by Congress and the administration.

As to minor mistakes, we are going to have them either way. It is human to err. The Reserve System is going to err.

The Treasury is going to err. The crucial question you have to ask is, "Over the long pull, which is less likely to make a major mistake?"

On the second bill, I think it would be a mistake to legislate a limit on the yield of Government securities. The rates of interest ought to be determined in the free market like other prices.

I think it is most undesirable for Congress to fix prices and, therefore, I myself would oppose a bill to fix the price or the yield on Government bonds.

Mr. BROCK. What would be the effect of such a bill?

Mr. FRIEDMAN. Such a bill would be evaded and would not have any significant effect on the price the Government had to pay to borrow.

You cannot force people to lend. If the Government needs to borrow how does it get the funds?

It either prints pieces of paper, in which case you have inflation, or it pays what it has to pay to borrow the funds. Not only are private people ingenious in getting around obstacles, but I think governmental officials are ingenious in getting around legal obstacles.

Mr. BROCK. Thank you, my time has expired.

The CHAIRMAN. Mr. Wilson?

Mr. WILSON. I have no questions.

The CHAIRMAN. Professor, you stated that we should have a moderate, steady, stable policy we can live with indefinitely.

Can you have that kind of a policy without the Federal Reserve System?

Mr. FRIEDMAN. Yes, indeed.

The CHAIRMAN. What changes would you make? Now, I believe that I am summing up the testimony before this committee in a few short sentences:

No. 1, I believe we have, most of us, been convinced that the Federal Reserve at the end of 50 years is not the same Federal Reserve that started out in 1913. In 1913 the policy was to give the people an adequate money supply, available to all of the people under reasonable conditions and terms and at a reasonable cost. They established what was known as eligible paper so as to encourage the banks to seek this kind of paper from farmers, small businessmen, and others. The banks could take eligible paper and put it up with the Federal Reserve and so it could be used as high-powered dollars upon which the banking system could create \$10 or more of credit dollars for every dollar obtained at the discount window.

Of course, that made it very profitable to the banks, which is as it should have been, because we must have a profitable banking system in order to have a good economic system.

Now, after a few years the Open Market Committee was established. Until that time each of the 12 banks were operating in opposition to one another. Some would be in the market selling bonds and some buying, and there was no coordination.

That is correct, is it not, Professor?

Mr. FRIEDMAN. Yes.

The CHAIRMAN. So they organized what was known as the unofficial Open Market Committee. They had no power to do this under the law.

Each bank was autonomous because that is the only way that President Wilson would permit it at the time, 12 separate regional banks, but this committee was organized and it was pretty effective because the Federal Reserve Board gave it its blessing and they operated as though they were an official open market committee.

Well, in the beginning certain groups in this country only wanted a Federal Reserve if the bankers could be on the Board and have influence in determining the volume of money, its availability, and its cost.

Others believed that the bankers should not be on the board.

Now, in 1913 when President Wilson took a firm stand against the bankers being on the boards he said that you might just as well put railroad owners on the Interstate Commerce Commission to fix freight rates as to put bankers on the Board to regulate money. You recall that story, I am sure.

So we did not have bankers on the Board. But they were represented on each one of these 12 Federal Reserve banks. And as time went on and this unofficial committee of the Reserve banks, the Open Market Committee, began to operate the banks who had always opposed the Federal Reserve began to look sympathetically upon it. And in 1926 or 1927, in that period of time when the Federal Reserve banks were going to expire—you see, they had 25- or 20-year charters. Which was it, 20 or 25?

Mr. FRIEDMAN. I am sorry, but I—

The CHAIRMAN. It was either 20 or 25, just like the old two banks in the past.

Mr. FRIEDMAN. The two banks in the past were 20 years but—

The CHAIRMAN. Yes, sir. So there was going to be an expiration time. But the Federal Reserve was pleasing the big banks more and more all the time, and the big money interests became more interested in it and they took the initiative years before the expiration of the charter to get the charter continued indefinitely, as it is today. They felt that the Fed would be in the hands of this Open Market Committee and so of men that this particular group wanted to control the monetary system.

In 1933 this group started trying to legalize the Open Market Committee. But the Committee was made up of the Presidents of each of the 12 banks. So the Committee represented the private bankers because the 12 Presidents were selected by boards of directors two-thirds of whose members were selected by the private banks and business. That did not look too good to anybody, just having the banking interests completely in control of that great power.

So, 2 years later, in 1935, it was changed and when the bill came before this committee, this committee stood firm. It didn't want any bankers on the Board. It wanted an Open Market Committee composed of people selected by the President and confirmed by the Senate, dedicated public servants, to operate our monetary system, and that is the way the bill left this committee.

It went through the House. The people who opposed the original Federal Reserve Act, for the reasons I have stated, also opposed this House bill.

They would not have any part of it when the bankers were not represented but when it went to the Senate, the Senate put the bankers back on the Open Market Committee, and then of course they all em-

braced it. It came back over here and it was passed unanimously. I mean, the conference report was passed practically unanimously, if not unanimously.

There was no opposition any more because the bankers were on the Board.

Now, the question is, Professor, Do you believe that because of people who are subjected to the bankers' influence all the time, people like the 12 Federal Reserve bank Presidents, and all of these advisory groups who are always conferring with our money managers, that the views of the bankers have a special influence on our money policies and this is not good because if it is handled right one way the bankers gain a lot and if it is not handled that way they do not make as much money?

Mr. FRIEDMAN. Well, I think that this is a very difficult and complicated question.

My impression, on reading the evidence and looking over the history, is that the bankers who have been associated with the Reserve System in all capacities have been, in the main, public-spirited citizens who have been trying to promote the interests of the public.

To this extent I would not agree that they have, in any deliberate way, used their position of influence on the system to promote their private interests.

On the other hand, there is no doubt that each of us is very much affected by the environment in which we are and know best those things which we are familiar with. And there is no doubt that from the point of view of the bankers, what they are individually familiar with is the credit and investment market.

To them it seemed perfectly natural and understandable in trying to serve the public interest to place major emphasis on interest rates and credit conditions rather than on the aggregate quantity of money. From this point of view, I think it has been an unfortunate thing that we have had a Reserve bank which has been as closely linked to the banking community and to the lending and investment process as it has, not at all because the individuals are trying to feather their own nests, not for that reason, but because they naturally interpreted the instrument they were dealing with in terms of the environment they knew best and were most familiar with.

And this was a wrong interpretation, as I see it, from the point of view of the public interest.

The CHAIRMAN. Substantially I agree with you, Professor. I do not impugn the motives of these people.

I think they are in an environment where they just naturally think that way and they think, honestly, to serve the public interest you have to serve the bankers and by serving the bankers you have to serve the public interest.

Mr. FRIEDMAN. Pardon me, but I do not believe that is the case either, because I think I can name times in history where bankers did things that they thought were against the—

The CHAIRMAN. Oh, I will agree with you; there have been times.

Mr. FRIEDMAN. So I do not think it is because they thought they were trying to serve the banks' interest.

The CHAIRMAN. I did not go that far. I said where they honestly believed—

Mr. FRIEDMAN. Oh, yes.

The CHAIRMAN. Now, we have these 12 great regional banks. We have enormous buildings, ivory towers, some people call them, super-buildings——

Mr. KILBURN. Will the chairman yield for just a question?

The CHAIRMAN. You see. I have not asked any questions at all. You see, I yielded——

Mr. KILBURN. You did not yield to me and I am an ex officio member——

The CHAIRMAN. Well, you will be next after me. Since I am the author of the bill I think I ought to ask some questions. I haven't asked all I want to ask yet because I yielded to the other members.

I did that when I was chairman of the Joint Economic Committee. I yielded to the other members first. I started it, and I think it's a pretty good plan. But I do want to ask a few questions on this.

Now we have all of these buildings all over the United States, and there is only one building that really operates the Federal Reserve System, and that is the Federal Reserve bank in New York.

The other business that is done in all of these dozens and dozens of big buildings over the Nation you could probably do in space no larger than this room.

I am referring to the business that is directly related to the administration of the Federal Reserve Act and nothing else.

Now, I know that they have largely engaged in clearing checks and things like that. That is the biggest item, of course. They employ 20,000 people. They draw good salaries, as I would expect them to draw.

I do not have any kick on that particular thing except some minor ones or some minor cases, where it seems like they are out of line.

Now these 20,000 people, what are they doing? They are clearing checks for the commercial banks.

I think this committee should consider hiring some management—— Mr. Reuss suggested that one time, and I think it is an excellent idea—— some management firm, experts in their line, to find out how much it would cost to clear all of these checks for all banks without reference to the Federal Reserve and maybe if it is the Government's duty to pay it we could pay it.

It might be a lot less than it is now. We are spending about \$200 million on the Federal Reserve now and about \$125 million of it is directly related to just paying for the clearing of checks that, under the law, the banks themselves are supposed to pay.

But since the Federal Reserve banks became so rich from buying Government bonds, which cost them nothing, collecting \$1 billion a year of interest on them, of course they are glad to pay all of these bills. Now, if we separated out this clearing of checks function, we would not have much left for the Federal Reserve banks to do.

Do you agree? How would you recommend that we liquidate the remainder of the Federal Reserve System? Would you set up an independent board responsive, as you have said, to the President of the United States and the administration in power?

How many many members would you recommend? How long a term?

Mr. FRIEDMAN. Well, let me go back, if I may, because there is no reason that I can see why the Government should subsidize the clearing of checks.

I see no reason why the clearing of checks should be a nationalized industry any more than why any other line of production should be nationalized. It seems to me that it would be desirable to require the private banking industry to do its own clearing of checks and to pay whatever costs are involved in that.

The clearing of checks does not seem to me to be anything that justifies a subsidy. So I would go beyond what you have suggested and say that check clearing should be done by private industry.

Beyond that, my major difficulty in answering your question is on what assumptions I answer them.

If I were to suppose that you passed the rule that was suggested, then the problem of the Federal Reserve System becomes primarily a straightforward administrative problem which should be handled by having a separate administrative body like any one of the operating agencies—

The CHAIRMAN. Like the FTC or ICC?

Mr. FRIEDMAN. Yes, only I think it would be preferable probably to have it as a branch of the Treasury, that it should be a bureau within the Treasury that has the special responsibility of seeing to it that the supply of money goes up at a steady rate.

If you do not want to go so far as that, if you want simply to eliminate the present independence of the board but leave it with discretion about how much it should change the quantity of money, what movements it should make, then I find it somewhat more difficult to answer the question. The function then becomes much more important and it is not clear that you would want to set it up as a bureau within the Treasury rather than as a separate, independent agency under the Executive Office of the President.

However, I hasten to say that you gentlemen are far more familiar with these problems of appropriate political organization than I am. I would only want to stress that the objective should be to have an administrative organization which is subject to the control of the President and of the Congress in the same way as the Treasury Department, the Commerce Department, and the other departments are.

(Article by Milton Friedman is inserted at this point in the record:)

#### SHOULD THERE BE AN INDEPENDENT MONETARY AUTHORITY?<sup>1</sup>

(Milton Friedman)

The text for this paper, to paraphrase the famous remark attributed to Poincaré, is, "Money is too important to be left to the central bankers." The problem that suggests this text is the one of what kind of arrangements to set up in a free society for the control of monetary policy. The believer in a free society—a "liberal" in the original meaning of the word, but unfortunately not in the meaning that is now current in this country—is fundamentally fearful of concentrated power. His objective is to preserve the maximum degree of freedom for each individual separately that is compatible with one man's freedom not interfering with other men's freedom. He believes that this objective requires power to be dispersed, that it be prevented from accumulating in any one person or group of people.

The need for dispersal of power raises an especially difficult problem in the field of money. There is widespread agreement that government must have some responsibility for monetary matters. There is also widespread recogni-

<sup>1</sup>From Leland B. Yeager (ed.), "In Search of a Monetary Constitution" (Cambridge, Mass.: Harvard University Press, 1962).

tion that control over money can be a potent tool for controlling and shaping the economy. Its potency is dramatized in Lenin's famous dictum that the most effective way to destroy a society is to destroy its money. It is exemplified in more pedestrian fashion by the extent to which control over money has always been a potent means of exacting taxes from the populace at large, very often without the explicit agreement of the legislature. This has been true from early times, when monarchs clipped coins and adopted similar expedients, to the present, with our more subtle and sophisticated modern techniques for turning the printing press or simply altering book entries.

The problem is to establish institutional arrangements that will enable government to exercise responsibility for money, yet will at the same time limit the power thereby given to government and prevent the power from being used in ways that will tend to weaken rather than strengthen a free society. Three kinds of solutions have developed or have been suggested. One is an automatic commodity standard, a monetary standard which in principle requires no governmental control. A second is the control of monetary policies by an "independent" central bank. A third is the control of monetary policies by rules that are legislated in advance by the legislature, are binding upon the monetary authority, and greatly limit its initiative. This paper discusses these three alternatives with rather more attention to the solution through a central bank.

#### A COMMODITY STANDARD

Historically, the device that has evolved most frequently in many different places and over the course of centuries is a commodity standard; that is, the use as money of some physical commodity such as gold, silver, brass, or tin, or cigarettes, cognac, or various other commodities. If money consisted wholly of a physical commodity of this type, in principle there would be no need for control by the government at all. The amount of money in society would depend on the cost of producing the monetary commodity rather than on other things. Changes in the amount of money would depend on changes in the technical conditions of producing the monetary commodity and on changes in the demand for money.

This is an ideal that animates many believers in an automatic gold standard. In point of fact, however, as the system developed it deviated very far from this simple pattern, which required no governmental intervention. Historically, a commodity standard—such as a gold standard or a silver standard—was accompanied by the development of alternative forms of money as well; of fiduciary money of one kind or another, ostensibly convertible into the monetary commodity on fixed terms. There was a very good reason for this development. The fundamental defect of a commodity standard, from the point of view of the society as a whole, is that it requires the use of real resources to add to the stock of money. People must work hard to dig something out of the ground in one place—to dig gold out of the ground in South Africa—in order to rebury it in Fort Knox, or some similar place. The necessity of using real resources for the operation of a commodity standard establishes a strong incentive for people to find ways to achieve the same result without employing these resources. If people will accept as money pieces of paper on which is printed "I promise to pay so much of the standard commodity," these pieces of paper can perform the same functions as the physical pieces of gold or silver, and they require very much less in resources to produce. This point, which I have discussed at somewhat greater length elsewhere,<sup>2</sup> seems to me the fundamental difficulty of a commodity standard.

If an automatic commodity standard were feasible, it would provide an excellent solution to the liberal dilemma of how to get a stable monetary framework without the danger of irresponsible exercise of monetary powers. A full commodity standard, for example, an honest-to-goodness gold standard in which 100 percent of the money consisted literally of gold, widely supported by a public imbued with the mythology of a gold standard and the belief that it is immoral and improper for government to interfere with its operation, would provide an effective control against governmental tinkering with the currency and against irresponsible monetary action. Under such a standard, any monetary powers of government would be very minor in scope.

<sup>2</sup> "A Program for Monetary Stability" (New York: Fordham University Press, 1959), pp. 4-8.

But such an automatic system has historically never proved feasible. It has always tended to develop in the direction of a mixed system containing fiduciary elements such as bank notes, bank deposits, or government notes in addition to the monetary commodity. And once fiduciary elements have been introduced, it has proved difficult to avoid government control over them, even when they were initially issued by private individuals. The reason is basically the difficulty of preventing counterfeiting or its economic equivalent. Fiduciary money consists of a contract to pay standard money. It so happens that there tends to be a long interval between the making of such a contract and its realization, which enhances the difficulty of enforcing the contract to pay the standard money and hence also the temptation to issue fraudulent contracts. In addition, once fiduciary elements have been introduced, the temptation for government itself to issue fiduciary money is almost irresistible. As a result of these forces, commodity standards have tended in practice to become mixed standards involving extensive intervention by the state, which leaves the problem of how intervention is to be controlled.

Despite the great amount of talk by many people in favor of the gold standard, almost no one today literally desires to see an honest-to-goodness full gold standard in operation. People who say they want a gold standard are almost invariably talking about the present kind of standard, or the kind of standard that was maintained in the 1930's, in which there is a small amount of gold in existence, held by the central monetary authority as "backing"—to use that very misleading term—for fiduciary money, and with the same authority, a central bank or other government bureau, managing the gold standard. Even during the so-called "great days" of the gold standard of the 19th century, when the Bank of England was supposedly running the gold standard skillfully, the monetary system was far from a fully automatic gold standard. It was even then a highly managed standard. And certainly the situation is now more extreme. Country after country has adopted the view that government has responsibility for internal stability. This development, plus the invention by Schacht of the widespread direct control of foreign exchange transactions, has meant that few, if any, countries are willing today to let the gold standard operate even as quasi-automatically as it did in the 19th century.

Most countries in the world currently behave asymmetrically with respect to the gold standard. They are willing to allow gold to flow in and even to inflate somewhat in response, but almost none is willing either to let gold flow out to any large extent or to adjust to the outflow by allowing or forcing internal prices to decline. Instead, they are very likely to take measures such as exchange controls, import restrictions, and the like.

My conclusion is that an automatic commodity standard is neither a feasible nor a desirable solution to the problem of establishing monetary arrangements for a free society. It is not desirable because it would involve a large cost in the form of resources used to produce the monetary commodity. It is not feasible because the mythology and beliefs required to make it effective do not exist.

#### AN INDEPENDENT CENTRAL BANK

A second device that has evolved and for which there is considerable support is a so-called independent monetary authority—a central bank—to control monetary policy and to keep it from being the football of political manipulation. The widespread belief in an independent central bank clearly rests on the acceptance—in some cases the highly reluctant acceptance—of the view I have just been expressing about a commodity standard, namely, that a fully automatic commodity standard is not a feasible way to achieve the objective of a monetary structure that is both stable and free from irresponsible governmental tinkering.

The device of an independent central bank embodies the very appealing idea that it is essential to prevent monetary policy from being a day-to-day plaything at the mercy of every whim of the current political authorities. The device is rationalized by assimilating it to a species of constitutionalism. The argument that is implicit in the views of proponents of an independent central bank—so far as I know, these views have never been fully spelled out—is that control over money is an essential function of a government comparable to the exercise of legislative or judicial or administrative powers. In all of these, it is important to distinguish between the basic structure and day-to-day operation within that structure. In our form of government, this distinction is made between the constitutional rules which set down a series of basic prescriptions and proscrip-



tions for the legislative, judicial, and executive authorities and the detailed operation of the several authorities under these general rules. Similarly, the argument implicit in the defense of an independent central bank is that the monetary structure needs a kind of a monetary constitution, which takes the form of rules establishing and limiting the central bank as to the powers that it is given, its reserve requirements, and so on. Beyond this, the argument goes, it is desirable to let the central bank have authority largely coordinate with that of the legislature, the executive, and the judiciary to carry out the general constitutional mandate on a day-to-day basis.

In recent times, the threat of extension of government control into widening areas of economic activity has often come through proposals involving monetary expansion. Central bankers have generally been "sound money men," at least verbally, which is to say, they have tended to attach great importance to stability of the exchange rate, maintenance of convertibility of the Nation's currency into other currencies and into gold, and prevention of inflation. They have therefore tended to oppose many of the proposals for extending the scope of government. This coincidence of their views in these respects with those of people like myself, who regard narrowly limited government as a requisite for a free society, is the source of much of the sympathy on the part of this group, whom I shall call "new liberals," for the notion of an independent central bank. As a practical matter, the central bankers seem more likely to impose restrictions on irresponsible monetary power than the legislative authority itself.

A first step in discussing this notion critically is to examine the meaning of the "independence" of a central bank. There is a trivial meaning that cannot be the source of dispute about the desirability of independence. In any kind of a bureaucracy, it is desirable to delegate particular functions to particular agencies. The Bureau of Internal Revenue can be described as an independent bureau within the Treasury Department. Outside the regular Government departments, there are separate administrative organizations, such as the Bureau of the Budget. This kind of independence of monetary policy would exist if, within the central administrative hierarchy, there were a separate organization charged with monetary policy which was subordinate to the chief executive or officer, though it might be more or less independent in routine decisions. For our purposes, this seems to me a trivial meaning of independence, and not the meaning fundamentally involved in the argument for or against an independent central bank. This is simply a question of expediency and of the best way to organize an administrative hierarchy.

A more basic meaning is the one suggested above—that a central bank should be an independent branch of government coordinate with the legislative, executive, and judicial branches, and with its actions subject to interpretation by the judiciary. Perhaps the most extreme form of this kind of independence in practice, and the form that comes closest to the ideal type envisaged by proponents of an independent central bank, has been achieved in those historical instances where an organization that was initially entirely private and not formally part of the government at all has served as a central bank. The leading example, of course, is the Bank of England, which developed out of a strictly private bank and was not owned by or formally a part of the Government until after World War II. If such a private organization strictly outside the regular political channels could not function as a central monetary authority, this form of independence would call for the establishment of a central bank through a constitutional provision which would be subject to change only by constitutional amendment. The bank would accordingly not be subject to direct control by the legislature. This is the meaning I shall assign to independence in discussing further whether an independent central bank is a desirable resolution of the problem of achieving responsible control over monetary policy.

It seems to me highly dubious that the United States, or for that matter any other country, has in practice ever had an independent central bank in this fullest sense of the term. Even when central banks have supposedly been fully independent, they have exercised their independence only so long as there has been no real conflict between them and the rest of the government. Whenever there has been a serious conflict, as in time of war, between the interests of the fiscal authorities in raising funds and of the monetary authorities in maintaining convertibility into specie, the bank has almost invariably given way, rather than the fiscal authority. To judge by experience, even those central banks that have been nominally independent in the fullest sense of the term have in fact been closely linked to the executive authority.

But of course this does not dispose of the matter. The ideal is seldom fully realized. Suppose we could have an independent central bank in the sense of a coordinate, constitutionally established, separate organization. Would it be desirable to do so? I think not, for both political and economic reasons.

The political objections are perhaps more obvious than the economic ones. Is it really tolerable in a democracy to have so much power concentrated in a body free from any kind of direct, effective political control? What I have called the "new liberal" often characterizes his position as involving belief in the rule of law rather than of men. It is hard to reconcile such a view with the approval of an independent central bank in any meaningful way. True, it is impossible to dispense fully with the rule of men. No law can be specified so precisely as to avoid problems of interpretation or to cover explicitly every possible case. But the kind of limited discretion left by even the best of laws in the hands of those administering them is a far cry indeed from the kind of far-reaching powers that the laws establishing central banks generally place in the hands of a small number of men.

I was myself most fully persuaded that it would be politically intolerable to have an "independent" central bank by the memoirs of Emile Moreau, the governor of the Bank of France during the period from about 1926 to 1928, the period when France established a new parity for the franc and returned to gold. Moreau was appointed governor of the Bank of France in 1926, not long before Poincaré became Premier after violent fluctuations in the exchange value of the franc and serious accompanying internal disturbances and governmental financial difficulties. Moreau's memoirs were edited and brought out in book form some years ago by Jacques Rueff, who was the leading figure in the recent French monetary reform.<sup>3</sup>

The book is fascinating on many counts. The particular respect that is most relevant for our present purpose is the picture that Moreau paints of Montagu Norman, governor of the Bank of England, on the one hand, and of Hjalmar Schacht, at that time governor of the Bank of Germany, on the other; they were unquestionably two of the three outstanding central bankers of the modern era, Benjamin Strong of the United States being the third. Moreau describes the views that these two European central bankers had of their functions and their roles, and implies their attitude toward other groups. The impression left with me—though it is by no means clear that Moreau drew the same conclusions from what he wrote, and it is certain that he would have expressed himself more temperately—is that Norman and Schacht were contemptuous both of the masses—of "vulgar" democracy—and of the classes—of the, to them, equally vulgar plutocracy. They viewed themselves as exercising control in the interests of both groups but free from the pressures of either. In Norman's view, if the major central bankers of the world would only cooperate with one another—and he had in mind not only himself and Schacht but also Moreau and Benjamin Strong—they could jointly wield enough power to control the basic economic destinies of the Western World in accordance with rational ends and objectives rather than with the irrational processes of either parliamentary democracy or laissez-faire capitalism. Though of course stated in obviously benevolent terms of doing the "right thing" and avoiding distrust and uncertainty, the implicit doctrine is clearly thoroughly dictatorial and totalitarian.

It is not hard to see how Schacht could later be one of the major creators of the kind of far-reaching economic planning and control that developed in Germany. Schacht's creation of extensive direct control of foreign exchange transactions is one of the few really new economic inventions of modern times. In the older literature, when people spoke of a currency as being inconvertible, they meant that it was not convertible into gold or silver or some other money at a fixed rate. To the best of my knowledge, it is only after 1934 that inconvertibility came to mean what we currently take it to mean; that it is illegal for one man to convert paper money of one country into paper money of another country at any terms he can arrange with another person.<sup>4</sup>

<sup>3</sup> Emile Moreau, "Souvenirs d'un Gouverneur de la Banque de France" (Paris: Génin [1954]).

<sup>4</sup> Another feature of Moreau's book that is most fascinating but rather off the main track of the present discussion is the story it tells of the changing relations between the French and British central banks. At the beginning, with France in desperate straits seeking to stabilize its currency, Norman was contemptuous of France and regarded it as very much of a junior partner. Through the accident that the French currency was revalued at a level that stimulated gold imports, France started to accumulate gold reserves and sterling reserves and gradually came into the position where at any time Moreau could have forced the British off gold by withdrawing the funds he had on deposit at the Bank of England.

I turn now to the economic or technical aspects of an independent central bank. Clearly there are political objections to giving the group in charge of a central bank so much power independent of direct political controls, but, it has been argued, there are economic or technical grounds why it is nevertheless essential to do so. In judging this statement, much depends on the amount of leeway that the general rule governing the central bank gives to it. I have been describing an independent central bank as if it could or would be given a good deal of separate power, as clearly is currently the case. Of course, the whole notion of independence could be rendered merely a matter of words if in fact the constitutional provision setting up the bank established the limits of its authority very narrowly and controlled very closely the policies that it could follow.

In the 19th century, when wide support for independent central banks developed, the governing objective of the central bank was the maintenance of exchange stability. Central banks tended to develop in countries that professed to have commodity currencies, which is to say had a fixed price for the commodity serving as the monetary standard in terms of the nominal money of the country. For two countries on the same standard, this meant a fixed rate of exchange between the corresponding national currencies. In consequence, the maintenance of such fixed rates had to be the proximate aim of the central bank if it was to achieve its major aim of keeping its currency convertible into standard money. The Bank of England, for example, was narrowly limited in what it could do by the necessity of keeping England on gold.

In the same way, in the United States when the Federal Reserve System was established in 1913, it never entered into the minds of the people who were establishing it that the System would really have much effective control internally in ordinary times. The Reserve System was established when the gold standard ruled supreme, and when it was taken for granted that the major factor determining the policy of the System, and hence the behavior of the stock of money in this country, would be the necessity of maintaining external equilibrium with the currencies of other countries. So long as the maintenance of a fixed exchange rate between one country's currency and the currencies of other countries was the overriding objective of policy, the amount of leeway available to the central bank was narrowly limited. It had some leeway with respect to minor movements of a short-term character, but it ultimately had to respond to the balance of payments.

The situation has changed drastically in this respect in the course of the past few decades. In the United States, which is of most immediate concern to us, the Reserve System had hardly started operations before the fundamental conditions taken for granted when it was established had changed radically. During World War I, most of the countries of the world went off gold. The United States technically remained on gold, but the gold standard on which it remained was very different from the one that had prevailed earlier. After the end of World War I, although other countries of the world gradually reestablished something they called the gold standard, the gold standard never again played the role which it had before. Prior to World War I, the United States was effectively a minor factor in the total world economy, and the necessity of maintaining external stability dominated our behavior. After the war, we had become a major factor to which other countries had to adjust. We held a very large fraction of the world's gold. Many countries never went back on gold, and those that did went back in a much diluted form. So never again has there been anything like the close domination of day-to-day policy by the gold standard that prevailed prior to 1914. Under these circumstances, "independence" of the central bank has become something meaningful, and not merely a technicality.

One defect of an independent central bank in such a situation is that it almost inevitably involves dispersal of responsibility. If we examine the monetary system in terms not of nominal institutional organization but of the economic functions performed, we find that the central bank is hardly ever the only authority in the Government that has essential monetary powers. Before the

---

The result was that Norman changed from being a proud boss and very much the senior partner to being almost a suppliant at the mercy of Moreau. Aside from the human drama, it emphasizes how important it is whether the rate of exchange is fixed 5 percent too low or 5 percent too high. Britain went back on gold in 1925 at a price of gold in terms of the pound that was probably something like 5 or 10 percent too low, and France went back de facto at the end of 1926 and de jure in mid-1928 at a price of gold in terms of francs that was 5 or 10 percent too high. This difference meant the difference between the French being at the mercy of the British and the British being at the mercy of the French.

Federal Reserve System was established, the Treasury exercised essential monetary powers. It operated like a central bank, and at times a very effective central bank. More recently, from 1933 to 1941, the Federal Reserve System was almost entirely passive. Such monetary action as were taken were taken predominantly by the Treasury. The Treasury engaged in open-market operations in its debt-management operations of buying and selling securities. It created and destroyed money in its gold and silver purchases and sales. The Exchange Stabilization Fund was established and gave the Treasury yet another device for engaging in open-market operations. When the Treasury sterilized and desterilized gold, it was engaging in monetary actions. In practice, therefore, even if something called an independent central bank is established and given exclusive power over a limited range of monetary matters, in particular over the printing of pieces of paper or the making of book entries called money (Federal Reserve notes and Federal Reserve deposits), there remain other governmental authorities, particularly the fiscal authority collecting taxes and dispersing funds and managing the debt, which also have a good deal of monetary power.

If one wanted to have the substance and not merely the form of an independent monetary authority, it would be necessary to concentrate all debt-management powers as well as all powers to create and destroy governmentally issued money in the central bank. As a matter of technical efficiency, this might well be desirable. Our present division of responsibility for debt management between the Federal Reserve and the Treasury is very inefficient. It would be much more efficient if the Federal Reserve did all of the borrowing and all of the managing of the debt, and the Treasury, when it had a deficit, financed it by getting money from the Federal Reserve System, and when it had a surplus, handed the excess over to the Federal Reserve System. But while such an arrangement might be tolerable if the Federal Reserve System were part of the same administrative hierarchy as the Treasury, it is almost inconceivable that it would be if the central bank were thoroughly independent. Certainly no government to date has been willing to put that much power in the hands of a central bank even when the bank has been only partly independent. But so long as these powers are separated, there is dispersal of responsibility, with each group separately regarding the other group as responsible for what is happening and with no one willing to accept responsibility.

In the past few years, I have read through the annual reports of the Federal Reserve System from 1913 to date, seriatim. One of the few amusing dividends from that ordeal was seeing the cyclical pattern that shows up in the potency that the authorities attribute to monetary policy. In years when things are going well, the reports emphasize that monetary policy is an exceedingly potent weapon and that the favorable course of events is largely a result of the skillful handling of this delicate instrument by the monetary authority. In years of depression, on the other hand, the reports emphasize that monetary policy is but one of many tools of economic policy, that its power is highly limited, and that it was only the skillful handling of such limited powers as were available that averted disaster. This is an example of the effect of the dispersal of responsibility among different authorities, with the likely result that no one assumes or is assigned the final responsibility.

Another defect of the conduct of monetary policy through an independent central bank that has a good deal of leeway and power is the extent to which policy is thereby made highly dependent on personalities. In studying the history of American monetary policy, I have been struck by the extraordinary importance of accidents of personality.

At the end of World War I, the Governor of the Federal Reserve System was W. P. G. Harding. Governor Harding was, I am sure, a thoroughly reputable and competent citizen, but he had a very limited understanding of monetary affairs, and even less backbone. Almost every student of the period is agreed that the great mistake of the Reserve System in postwar monetary policy was to permit the money stock to expand very rapidly in 1919 and then to step very hard on the brakes in 1920. This policy was almost surely responsible for both the sharp postwar rise in prices and the sharp subsequent decline. It is amusing to read Harding's answer in his memoirs to criticism that was later made of the policies followed. He does not question that alternative policies might well have been preferable for the economy as a whole, but emphasizes the Treasury's desire to float securities at a reasonable rate of interest, and calls attention to a then-existing law under which the Treasury could replace the head of the Reserve System. Essentially he was saying the same thing that I heard another member of the Reserve Board say shortly after World War II when the bond-

support program was in question. In response to the view expressed by some of my colleagues and myself that the bond-support program should be dropped, he largely agreed but said, "Do you want us to lose our jobs?"

The importance of personality is strikingly revealed by the contrast between Harding's behavior and that of Emile Moreau in France under much more difficult circumstances. Moreau formally had no independence whatsoever from the central government. He was named by the Premier, and could be discharged at any time by the Premier. But when he was asked by the Premier to provide the Treasury with funds in a manner that he considered inappropriate and undesirable, he flatly refused to do so. Of course, what happened was that Moreau was not discharged, that he did not do what the Premier had asked him to, and that stabilization was rather more successful. I cite this contrast neither to praise Moreau nor to blame Harding, but simply to illustrate my main point, namely, the extent to which a system of this kind is really a system of rule by men and not by law and is extraordinarily dependent on the particular personalities involved.

Another occasion in U.S. history which strikingly illustrates this point is our experience from 1929 to 1933. Without doubt, the most serious mistake in the history of the Reserve System was its mismanagement of monetary matters during those years. And this mismanagement, like that after World War I, can very largely be attributed to accidents of personality. Benjamin Strong, Governor of the Federal Reserve Bank of New York from its inception, was the dominant figure in the Reserve System until his death at a rather early age in 1928. His death was followed by a shift of power in the System from New York to Washington. The people in Washington at the time happened to be fairly mediocre. Moreover, they had always played a secondary role, were not in intimate touch with the financial world, and had no background of long experience in meeting day-to-day emergencies. Further, the chairmanship changed hands just prior to the shift of power and again in mid-1931. Consequently, in the emergencies that came in 1929, 1930, and 1931, particularly in the fall of 1930, when the Bank of United States failed in New York as part of a dramatic series of bank failures, the Federal Reserve System acted timorously and passively. There is little doubt that Strong would have acted very differently. If he had still been Governor, the result would almost surely have been to nip the wave of bank failures in the bud and to prevent the drastic monetary deflation that followed.

A similar situation prevails today. The actions of the Reserve System depend on whether there are a few persons in the System who exert intellectual leadership, and on who these people are; its actions depend not only on the people who are nominally the heads of the System but also on such matters as the fate of particular economic advisers.

So far, I have listed two main technical defects of an independent central bank from an economic point of view; first, dispersal of responsibility, which promotes shirking responsibility in times of uncertainty and difficulty, and second, an extraordinary dependence on personalities, which fosters instability arising from accidental shifts in the particular people and the character of the people who are in charge of the system.

A third technical defect is that an independent central bank will almost inevitably give undue emphasis to the point of view of bankers. It is exceedingly important to distinguish two quite different problems that tend to be confused: the problem of credit policy and the problem of monetary policy. In our kind of monetary or banking system, money tends to be created as an incident in the extension of credit, yet conceptually the creation of money and the extension of credit are quite distinct. A monetary system could be utterly unrelated to any credit instruments whatsoever; for example, this would be true of a completely automatic commodity standard, using only the monetary commodity itself or warehouse receipts for the commodity as money. Historically, the connection between money and credit has varied widely from time to time and from place to place. It is therefore essential to distinguish policy issues connected with interest rates and conditions on the credit market from policy issues connected with changes in the aggregate stock of money, while recognizing, of course, that measures taken to affect the one set of variables may also affect the other, and that monetary measures may have credit effects as well as monetary effects proper.

It so happens that central bank action is but one of many forces affecting the credit market. As we and other countries have seen time and again, a central bank may be able to determine the rate of interest on a narrow range of securities, such as the rate of interest on a particular category of Government

bonds, though even that only within limits and only at the expense of completely giving up control over the total stock of money. A central bank has never been able to determine, at all closely, rates of interest in any broader or more fundamental sense. Postwar experience in country after country that has embarked on a cheap-money policy has strikingly demonstrated that the forces which determine rates of interest broadly conceived—rates of return on equities, on real property, on corporate securities—are far too strong and widespread for the central bank to dominate. It must sooner or later yield to them, and generally rather soon.

The central bank is in a very different position in determining the quantity of money. Under systems such as that in the United States today, the central bank can make the amount of money anything it wishes. It may, of course, choose to accept some other objective and give up its power over the money supply in order to try to keep "the" or "a" rate of interest fixed, to keep "free reserves" at a particular level, or to achieve some other objective. But if it wishes, it can exercise complete control over the stock of money.

This difference between the position of the central bank in the credit markets and in determining the money supply tends to be obfuscated by the close connection between the central bank and the banking community. In the United States, for example, the Reserve banks technically are owned by their member banks. One result is that the general views of the banking community exercise a strong influence on the central bank and, since the banking community is concerned primarily with the credit market, central banks are led to put altogether too much emphasis on the credit effects of their policies and too little emphasis on the monetary effects of their policies.

In recent times, this emphasis has been attributed to the effects of the Keynesian revolution and its treatment of changes in the stock of money as operating primarily through the liquidity preference function on the interest rate. But this is only a particular form of a more general and ancient tendency. The real-bills doctrine, which dates back a century and more, exemplifies the same kind of confusion between the credit and the monetary effects of monetary policy. The banking and currency controversy in Britain in the early 19th century is a related example. The central bank emphasized its concern with conditions in the credit market. It denied that the quantity of money it was creating was in any way an important consideration in determining price levels or the like, or that it had any discretion about how much money to create. Much the same arguments are heard today.

The three defects I have outlined constitute a strong technical argument against an independent central bank. Combined with the political argument, the case against a fully independent central bank is strong indeed.

#### LEGISLATED RULES

If this conclusion is valid, if we cannot achieve our objectives by giving wide discretion to independent experts, how else can we establish a monetary system that is stable, free from irresponsible governmental tinkering, and incapable of being used as a source of power to threaten economic and political freedom? A third possibility is to try to achieve a government of law instead of men literally by legislating rules for the conduct of monetary policy. The enactment of such rules would enable the public to exercise control over monetary policy through its political authorities, while at the same time preventing monetary policy from being subject to the day-to-day whim of political authorities.

The argument for legislating rules for monetary policy has much in common with a topic that seems at first altogether different, namely, the Bill of Rights to the Constitution. Whenever anyone suggests the desirability of a legislative rule for control over money, the stereotyped answer is that it makes little sense to tie the monetary authority's hands in this way because the authority, if it wants to, can always do of its own volition what the rule would require it to do, and, in addition, has other alternatives; hence "surely," it is said, it can do better than the rule. An alternative version of the same argument applies to the legislature. If the legislature is willing to adopt the rule, it is said, surely it will also be willing to legislate the "right" policy in each specific case. How then, it is said, does the adoption of the rule provide any protection against irresponsible political action?

The same argument could apply with only minor verbal changes to the first amendment to the Constitution and, equally, to the entire Bill of Rights. Is it not absurd, one might say, to have a general proscription of interference with free speech? Why not take up each case separately and treat it on its own merits?

Is this not the counterpart to the usual argument in monetary policy that it is undesirable to tie the hands of the monetary authority in advance; that it should be left free to treat each case on its merits as it comes up? Why is not the argument equally valid for speech? One man wants to stand up on a street corner and advocate birth control; another, communism; a third, vegetarianism; and so on, ad infinitum. Why not enact a law affirming or denying each the right to spread his particular views? Or, alternatively, why not give the power to decide the issue to an administrative agency? It is immediately clear that if we were to take up each case separately, a majority would almost surely vote to deny free speech in most cases and perhaps even in every case. A vote on whether Mr. X should spread birth control propaganda would almost surely yield a majority saying "no"; and so would one on communism. The vegetarian might perhaps get by, although even that is by no means a foregone conclusion.

But now suppose all these cases were grouped together in one bundle, and the populace at large was asked to vote for them as a whole: to vote whether free speech should be denied in all cases or permitted in all alike. It is perfectly conceivable, if not highly probable, that an overwhelming majority would vote for free speech; that, acting on the bundle as a whole, the people would vote exactly the opposite to the way they would have voted on each case separately. Why? One reason is that each person feels much more strongly about being deprived of his right to free speech when he is in a minority than he feels about depriving somebody else of the right to free speech when he is in the majority. In consequence, when he votes on the bundle as a whole, he gives much more weight to the infrequent denial of free speech to himself when he is in the minority than to the frequent denial of free speech to others. Another reason, and one that is more directly relevant to monetary policy, is that if the bundle is viewed as a whole, it becomes clear that the policy followed has cumulative effects that tend neither to be recognized nor taken into account when each case is voted on separately. When a vote is taken on whether Mr. Jones may speak on the corner, it is not clearly affected by favorable effects of an announced general policy of free speech, and an affirmative vote will not produce these effects. In voting on the specific case, it is only peripherally relevant that a society in which people are not free to speak on the corner without special legislation is a society in which the development of new ideas, experimentation, change, and the like are all hampered in a great variety of ways. That these ways are obvious to all is due to our good fortune of having lived in a society that did adopt the self-denying ordinance of not considering each case of speech separately.

Exactly the same considerations apply in the monetary area. If each case is considered on its merits, the wrong decision is likely to be made in a large fraction of cases because the decisionmakers are examining only a limited area and are not taking into account the cumulative consequences of the policy as a whole. On the other hand, if a general rule is adopted for a group of cases as a bundle, the existence of that rule has favorable effects on people's attitudes and beliefs and expectations that would not follow even from the discretionary adoption of precisely the same policy on a series of separate occasions.

Of course, the general rule need not be explicitly written down or legislated. Unwritten constitutional limitations supported unthinkingly by the bulk of the people may be as effective in determining decisions in individual cases as a written constitution. The analogy in monetary affairs is the mythology of gold, referred to earlier as a necessary ingredient of a gold standard if it is to serve as an effective bulwark against discretionary authority.

If a rule is to be legislated, what rule should it be? The rule that has most frequently been suggested by people of a generally "new liberal" persuasion is a price-level rule; namely, a legislative direction to the monetary authorities that they maintain a stable price level. I think this is the wrong kind of rule. It is the wrong kind of rule because the objectives it specifies are ones that the monetary authorities do not have the clear and direct power to achieve by their own actions. It consequently raises the earlier problem of dispersing responsibilities and leaving the authorities too much leeway. There is unquestionably a close connection between monetary actions and the price level. But the connection is not so close, so invariable, or so direct that the objective of achieving a stable price level is an appropriate guide to the day-to-day activities of the authorities.

The issue of what rule to adopt is one that I have considered at some length elsewhere.<sup>5</sup> Accordingly, I will limit myself here to stating my conclusion. In

<sup>5</sup> "A Program for Monetary Stability," pp. 77-99.

the present state of our knowledge, it seems to me desirable to state the rule in terms of the behavior of the stock of money. My choice at the moment would be a legislated rule instructing the monetary authority to achieve a specified rate of growth in the stock of money. For this purpose, I would define the stock of money as including currency outside commercial banks plus all deposits of commercial banks. I would specify that the Reserve System should see to it that the total stock of money so defined rises month by month, and indeed, so far as possible, day by day, at an annual rate of  $x$  percent, where  $x$  is some number between 3 and 5. The precise definition of money adopted and the precise rate of growth chosen make far less difference than the definite choice of a particular definition and a particular rate of growth.

I should like to emphasize that I do not regard this proposal as a be-all and end-all of monetary management, as a rule which is somehow to be written in tablets of gold and enshrined for all future time. It seems to me to be the rule that offers the greatest promise of achieving a reasonable degree of monetary stability in the light of our present knowledge. I would hope that as we operated with it, as we learned more about monetary matters, we might be able to devise still better rules which would achieve still better results. However, the main point of this paper is not so much to discuss the content of these or alternative rules as to suggest that the device of legislating a rule about the stock of money can effectively achieve what an independent central bank is designed to achieve but cannot. Such a rule seems to me the only feasible device currently available for converting monetary policy into a pillar of a free society rather than a threat to its foundations.

The CHAIRMAN. Professor Friedman, do you know any justification for such an important part of our Government as the monetary authority, which determines the volume of money, the availability of credit, and the cost of both, to be in the hands of people who feel like they are away from the Government to the extent where they can have a secret meeting every 3 weeks here in Washington, telling no one what happened, telling no one what is going to happen? Do you find any justification for that sort of conduct in a democracy or in a republic?

Mr. FRIEDMAN. I do not find any justification for giving such large powers to a small number of individuals regardless of whether they exercise them in secret meetings or open meetings.

The CHAIRMAN. It is doubly bad because of the secrecy, though, is it not?

Mr. HARVEY. Mr. Chairman, now that the bell has rung I would like to ask a question of the chairman as to when we can expect the full committee to have an executive meeting?

I know that that is what Mr. Kilburn wanted to ask you.

The CHAIRMAN. I do not know. We wanted to get the hearings finished. We feel like they are important.

Two Governors of the Federal Reserve Board are witnesses tomorrow. We have heard all of them except these two, and you gentlemen have been wanting Mr. Dillon here and he will be here day after tomorrow, and then we have some other witnesses.

We want to make a credible package out of this, if we can, by having full and complete testimony from both sides, something that we will be proud of, and I believe that we can be.

We are getting a record here that I think all the members are going to be proud of, especially the committee members, and I believe that there is great interest in this particular hearing, and I would not like to just disband it until we are really through. I think in a couple of weeks we will be through enough—

Mr. HARVEY. I would like to ask you this, that we have an executive meeting of the full committee before that time because I think the



chairman is aware, as all of us are who receive mail on the matters that come up—and I think that we should have one before that—

The CHAIRMAN. Well, I am sorry that Mr. Kilburn left, and I will not discuss it on that account. I have no comment on that.

I have nothing to hide on that—

Mr. HARVEY. I am sure the chairman does not, but I merely mention it because I am sure all of the members are interested in it, and the things—

The CHAIRMAN. Well, what would be the object of a meeting?

Mr. HARVEY. I think, to discuss the policy of the committee.

The CHAIRMAN. Well, we have discussed the policy of the committee, and the chairman has certain powers—

Mr. WIDNALL. That is just the question, Mr. Chairman, whether or not the chairman has the powers—

The CHAIRMAN. Well, get up a statement and give it to me and whatever charges are made will certainly get consideration. You will get consideration quickly, but let's have some charges now.

Mr. WIDNALL. Mr. Chairman, nobody has made any charges. Information has been requested and that is what Mr. Kilburn wanted to discuss before the full committee, and it seemed to me like a reasonable request.

Mr. HARVEY. I do not think we should have to—I did not make my request clear—

The CHAIRMAN. Let's do not—

Mr. HARVEY. In the light of making any charges other than the fact that I was aware of the situation, I thought it would behoove the committee if we are going to live together and get along together, to sit down and discuss it. It seems to me that we should.

The CHAIRMAN. Well, I do not know of a thing that the chairman has done that any chairman cannot do under the rules of the House. If I have done anything wrong I am willing to listen to anybody who wants—

Mr. HARVEY. I respect the chairman a great deal, and I think he knows that, and I also respect the gentleman from New York, but—

The CHAIRMAN. Well, get me up a statement. Get me a memo. Let's have something so that we will know what we are meeting about.

If there is any constructive reason to have a meeting we will have one right away, but if there is no constructive reason I do not want to interrupt these hearings.

We are going pretty well on these hearings. We certainly had one of the most important witnesses that we could have in the entire world here with us this morning, and he has given us wonderful testimony. His contribution here is going to be great, and this record will be of great importance.

Mr. WIDNALL. Mr. Chairman, do I understand you to say that you have no desire or intention of having an executive meeting for discussing the problem posed by Mr. Kilburn unless somebody makes charges against you, Mr. Chairman?

The CHAIRMAN. No, I did not say it that way. I said if anyone wants a meeting of the committee, like the minority, that they should state what they want it for and if they want it for a constructive reason, within the rules, it will be granted. I have no desire to keep the minority from having a meeting when they want it. It is perfectly all

right. But I do not want to interrupt good hearings, constructive hearings.

Incidentally, you gentlemen have never favored—you have been against it. You started in fighting it when we started our hearings—

Mr. WIDNALL. Mr. Chairman, we did not fight having hearings in connection with evaluating the Federal Reserve System.

I would like to see documented in the record any minority statement saying we should not have a look at 50 years of operation of the Federal Reserve System.

We did not fight that. And, for the record, and it should be in the record right now once again—is that not true, Mr. Harvey?

Mr. HARVEY. That is certainly true.

The CHAIRMAN. Well, I think you will find right in the beginning of the record some statement that you did not look with pleasure on it at all.

Mr. HARVEY. Let me say this, Mr. Chairman, and I think right now there are a great many members—I do not know how those on the majority side feel—but on the minority side there is considerable feeling about the direction we have been pursuing and that is why I suggested, meaning no offense to the chairman whatsoever, that I thought also to sit down in executive session, if only for a few minutes.

The CHAIRMAN. Well, I will ask the minority member to prepare any statement or memo for my information that would justify me in calling an executive session of the whole committee now, and the reasons for it, and if it will serve a constructive purpose you can rest assured it will be done.

We will set these hearings aside and have the meeting, but unless it is compelling in some way I would be very reluctant to set these hearings aside.

We have gone to a lot of trouble to arrange with witnesses to come here, and you cannot get a time that is suitable to everybody. You have to have one that is mutually satisfactory, and you cannot always do that.

We have had great difficulty with some witnesses and even with Professor Friedman. We have had him scheduled for about 2 weeks and postponed from time to time. We just cannot get things done like we want to.

Mr. WIDNALL. May I make a further observation, Mr. Chairman?

The CHAIRMAN. Yes, sir.

Mr. WIDNALL. There has been no hesitancy to call meetings prior to 10 o'clock for consideration of a matter, where it was thought necessary, by the chairman, and I certainly think that the point that has been made by Mr. Kilburn in his letter to you, and his own request to you, would be something that could be settled very quickly in the committee, and it seems to me a reasonable request, as I understand it. This is the whole point that I have been making.

The CHAIRMAN. Well, I will just ask Mr. Kilburn to prepare a memo to me setting forth why he would like to have a hearing. I think this committee is the one that should have the executive session because we are conducting the hearings on it and at the same time I would not be adverse to having one of the whole committee, if reasons are given to justify quitting what we are doing, to take it up. That is all I want, just a statement.

Mr. WIDNALL. Mr. Chairman, one further statement: I think you just said that Mr. Dillon will be coming up on Thursday, as we have wanted. Is it my understanding that you do not want Mr. Dillon to appear before the committee?

The CHAIRMAN. Oh, no. I said that is one reason why we do not want to interrupt the hearings. We have been trying to get him but he has been busy in the tax fight and other matters, and with the Joint Economic Committee, and we could not agree on the time, and I tried to explain it to you gentlemen. He did not want to do it, and I did not want him to interrupt his schedule, but you gentlemen seemed to be displeased.

You wanted him up quickly and now then, since we could not get him up quickly we are going to have him the day after tomorrow and for that reason I thought especially you would want to go ahead without any interruptions. That is the reason I brought that up.

We will stand recessed until 10 o'clock in the morning.

(Whereupon, at 12:10 p.m., the committee was recessed, to reconvene at 10 a.m., Wednesday, March 4, 1964.)

# THE FEDERAL RESERVE SYSTEM AFTER 50 YEARS

WEDNESDAY, MARCH 4, 1964

HOUSE OF REPRESENTATIVES,  
SUBCOMMITTEE ON DOMESTIC FINANCE OF THE  
COMMITTEE ON BANKING AND CURRENCY,  
*Washington, D.C.*

The subcommittee met, pursuant to recess, at 10 a.m., in room 1301, Longworth House Office Building, Hon. Wright Patman (chairman) presiding.

Present: Representatives Patman, Reuss, Vanik, Moorhead, Weltner, Hanna, Kilburn, Widnall, Bolton, and Brock.

The CHAIRMAN. The committee will please come to order.

We are glad to have the other two members of the Board of Governors here, and when I say "other two" I mean the two that we have not heard from. We have heard from the other five.

We are glad to have Mr. George W. Mitchell and Mr. J. Dewey Daane.

Mr. Daane is the most recent addition to the Board of Governors' team.

Mr. Mitchell, you have a prepared statement and so does Mr. Daane. You may proceed in your own way.

We will place the statements in the record, as you appear, and then if you want to summarize them and bring out the high points, that will be fine, with the understanding, of course, that we look over this record very carefully and give your full statement consideration anyway. After you have finished, the members of the committee will interrogate you.

So, Mr. Mitchell, you may proceed in your own way.

## STATEMENT OF HON. GEORGE W. MITCHELL, MEMBER OF THE BOARD OF GOVERNORS, FEDERAL RESERVE SYSTEM

Mr. MITCHELL. Well, Mr. Chairman, I think perhaps the most expeditious thing for me to do will be to read the statement.

The CHAIRMAN. That will be perfectly all right.

Mr. MITCHELL. And it is really divided into three parts.

At the outset I have some comments on the proposals incorporated in the bills dealing with changes and the structure of the Federal Reserve System—

The CHAIRMAN. Yes, sir.

Mr. MITCHELL (continuing). And then I have a middle section which contains some material on bank earnings over the past 10 years that you requested and, finally, I have a section dealing with some of the money supply theories that the committee has been hearing about.

Now, the statement does include some tables and appendix material. I do not plan to read those, but—

The CHAIRMAN. We will place them in the record, but if you can get through well within an hour it will be appreciated.

Mr. MITCHELL. It will not take me that long. Very good.

The CHAIRMAN. Yes.

Mr. MITCHELL. In my judgment there are no significant benefits or losses to be realized by changing the number of persons on the Board from seven to five, or nine. A board larger than nine would tend to become progressively more cumbersome and needlessly duplicative of points of view. A board smaller than five would diminish the potential advantages of differing points of view and delegate more policy-type decisions to staff.

As for the length of term for Board members, it seems to me a 4-year term would have the unfortunate selective effect of eliminating many well qualified individuals who could not consider appointment to the Board for that length of time at prevailing salaries. Business, banking and academic employment today are far more attractive than Government posts, especially for men in the prime of their careers with limited independent means. Perhaps an even more important deterrent to recruiting qualified candidates is the fact that a Board member must, and quite properly so, sever business and financial connections on which his future economic prospects and security had theretofore depended. Unless a man has substantial independent personal or family means or unless he expects to complete his working career within the period for which he is appointed to the Board, the length of the term he can look forward to is a significant consideration in determining his availability. It is my opinion that a term longer than 4 years is needed to provide the President with a suitable panel of competent men whose independence of judgment is least exposed to considerations of personal or family necessity. On the other hand, I doubt that a 14-year term is needed to achieve whatever contribution job security can make to quality and independence of Board members; my suggestion would be a minimum of 6 or 7 years and a maximum of 10 to 12.

#### ABOLITION OF FEDERAL OPEN MARKET COMMITTEE

During the period since I became a member of the Board of Governors—September 1961—it has consistently been plain to me that the members of the Federal Open Market Committee, whether from the Board of Governors or from the Federal Reserve banks, have made open market policy decisions on the basis of their individual evaluations of the public interest. This statement does not rest on the fact that I admire their independence of judgment because they tend to reach the same conclusions I do—most of them don't—but rather on my observation that on any given public policy the views and reasoning expressed in committee deliberations reflect the man, whether he lives in Washington or not.

The committee's policy record supports this judgment. Looking at the voting record on the policy directives from September 1961 through the end of 1963, there were 55 dissenting votes cast on directives relating to current policy. Abstracting the dissenting votes cast by me and one of my colleagues at a time during this period when

we concluded that a policy of greater monetary ease than the one described in the directive would have been desirable, the record shows that 17 dissenting votes were cast by members of the committee who were members of the Board of Governors, and that 16 dissenting votes were cast by members of the committee who were from the Federal Reserve banks. Within the latter group, eight of the dissenting votes reflected a view that a policy of lesser ease would have been desirable, while an equal number of dissenting votes reflected a view that a policy of greater ease would have been desirable. These dissenting votes were cast by six different Presidents who sat on the committee at one time or another during the period. Dissents by members of the Board were also to the right and left of the majority—for less ease—for greater ease. Looking at individual voting records, President Hayes, Governors Balderston, Shepardson, and Mills have at times over this period voted against the majority in favor of less ease. Presidents Bopp, Clay, Scanlon, Bryan, Deming, and Governors Robertson, Mills, King, and I at times voted against the majority in favor of more ease. From this record I detect no more bias in one direction or another among the Presidents than can be found on the Board.

My reason for favoring a continuation of the Open Market Committee more or less as presently constituted is not primarily negative, however. I think that regional representation from men whose day-to-day business activities keep them in touch with industrial, commercial and banking developments in the major centers of the Nation brings to the committee qualitative judgments and insights that aggregative statistics will always lack.

#### AUDIT

The word "audit" automatically claims the support and endorsement of everyone who has nothing to hide. But there should be a recognition that from a practical standpoint we cannot afford audit, audit, and reaudit. Verifying the existence and accuracy of the assets and liabilities shown on Federal Reserve balance sheets and determining if expenditures at the Federal Reserve banks are consonant with legal requirements and guidelines laid down by the Federal Reserve Board is achieved by internal auditing procedures at each Reserve bank and by the Board of Governors independent examinations. I believe these are ample guarantees that the Reserve banks' accounts and spending are fully policed. So far as I am aware, the examination of several thousand vouchers by the Committee staff did not uncover either any falsification of the balance sheet statements or any deviation from statutory requirements or from Board guidelines. This is corroborative evidence that a third verification and audit at the Reserve banks would waste resources that could be better employed elsewhere. Moreover, I believe it unwise to so constrain management decisions that the business of Government is operated not with a view to getting the job done, but with a view to what a third set of auditors may say about how it was done. Compared with Federal agencies, the Federal Reserve System is not very large but I believe it gains in operating efficiency from the decentralization of management responsibility to administrators on the site.

The term "auditing" is also used to refer to a review of management policies, procedures, and standards. This is a type of audit to be used

with special expertise lest there be a tendency to substitute the auditor's judgment for that of the operating officer who bears the responsibility for performance as well as costs. An illustration can be found in the cost of providing security in Reserve banks where vast sums of currency, coin, and securities are handled daily. The expenditure for protection must be reasonably related to the exposure to possible loss. An auditor might criticize an expenditure for guards as excessive but his judgment does not assume any responsibility if a loss is actually incurred.

This is not to say that I believe it inappropriate for the GAO, or any officially designated agency, to review the operational standards and techniques in the Federal Reserve System to see if they conform to the best in present day management practices. On the contrary, I would welcome such an examination. In fact, within the organization of the Board of Governors there is such a unit continuously screening technical operations at the Reserve banks with a view to achieving the most economical and expeditious manner of processing securities, checks, currency, coin, or just facts.

Some criticism has been made of the president of the Reserve banks for expenditures on employee welfare, community activities, employee education, and the entertainment of visitors and guests. If any criticism is made I believe it should be of the Board of Governors for guidelines it has prescribed. However, I believe the guidelines as they stand are satisfactory. It is true they provide for considerable discretion on the part of the presidents and their boards of directors but I see no evidence this discretion has been abused. It should be borne in mind that the Federal Reserve banks provide many people with their first job and education on the job is needed to develop the new worker's potential. Average salaries at the Reserve banks are low—about \$5,000—and welfare-educational programs are especially appropriate.

#### FEDERAL RESERVE ACCOUNTING

Over the years some students of central banking have suggested that it would aid public understanding and approval of sound monetary policies if the financial statements and reporting of the Federal Reserve did not follow conventional accounting lines but were made uniquely applicable to central bank operations.

I believe the System has done better to follow conventional business accounting practices on its operating statements and balance sheets. The magic of monetary creation may thereby be blurred but at least the present system has the virtue of requiring the System to show sources of receipts to cover expenses and payments to the Treasury and it also establishes the principle that for every investment expenditure there be an equivalent balance sheet asset. These accounting conventions have more than a fictitious value in setting the rules by which the central bank operates and they are safeguards against at least some abuses of monetary power.

In this context it seems to me that the size of the Federal Reserve surplus is not particularly significant, even if it were regarded as a "sinking fund" for the retirement of the public debt. Whether or not member banks should be permitted to own stock in the Reserve banks should be decided on other grounds, namely on the grounds of encouraging System membership.

The main reason that more banks do not belong to the Federal Reserve System is that it is more profitable to stay out. The nonmembers usually benefit from having lower reserve requirements, or none at all, and some of them benefit by collecting fees for clearing checks. Both of these advantages to the nonmember banks are really disadvantageous to the public interest. Among the member banks there are many that would become nonmembers if the advantages of membership were to become slightly less—one of these marginal advantages is the dividend on Federal Reserve stock. I believe it would be unwise to make membership in the System any more costly from a competitive standpoint than it is now.

#### MEMBER BANK EARNINGS, 1954-63

Now, gentlemen, this section on member bank earnings contains reference to attached tables 1-9, which you might want to be following as I read my discussion.

What I have attempted to do here is to show what has happened to the gross income of the member banks in the United States, over the past 10 years, and the impact of the changes in the interest rates, the changes in the capital accounts, the changes in expenses, and then the net of all of this on the earnings of these banks.

The data are set up by Reserve city and country banks to provide you with a look at the differences that can be attributable to differences in the size of the banks.

The Reserve city banks would tend to be banks of over \$100 million, and the country banks would, of course, be very much smaller.

Over the past 10 years, gross revenues of member banks have increased by 130 percent. Member bank operating expenses, however, have risen even faster, or more than 160 percent. Reflecting the more rapid growth in operating expenses than in revenues, net current earnings before income taxes grew by 77 percent and net income after taxes by 66 percent. The ratio of net income to capital fluctuated from year to year, but showed no marked change over the period.

Data are shown separately for Reserve city and country banks, a breakdown which also provides a rough indication of the differences in operating experience between large banks and those of smaller size.

Rates of growth in net current earnings (table II) over the 10-year period were identical at Reserve city and country banks, but country banks experienced a somewhat slower rise than city banks in net income after taxes (table III). The somewhat slower growth in net income after taxes than in net current earnings before taxes reflects in part the relatively large additions to income in the base year from profits on the sale of securities. Such profits, which are included in net income but not in net current earnings, were particularly large in 1954, a recession year, when interest rates were depressed and market values of fixed-income securities relatively high.

The rate of return on bank capital (table V), as measured by the ratio of net income to total capital accounts, has fluctuated somewhat from year to year, mainly because of the erratic behavior of nonoperating adjustments, particularly profits and losses on the sale of securities. Over the period, Reserve city banks earned a slightly higher average return on capital than country banks, 9 percent compared with 8.7 percent. At each class of banks, this rate exhibited a slight uptrend,



averaging about one-half of 1 percentage point higher in the last 5 years than in the first 5. This small rise relative to the increase in net income reflects the substantial growth in member bank capital accounts (table IV) since 1954, mostly from retained earnings. The increase in capital accounts at Reserve city banks was 67 percent, or nearly as much as the growth in net income, while the increase at country banks, 82 percent, substantially exceeded the rise in net income.

#### REVENUES

An important factor contributing to the growth in member bank revenues (table I) over the past decade was the rise in interest return on both loans and investments associated with the general advance in market rates of interest. Of even greater significance, however, was the growth in total earning assets as commercial bank loans and investments were expanded to accommodate growth of the domestic economy. Assets shifts and increases in service charges and trust department fees also made significant contributions to bank revenues over this period.

The average rate of return on loans outstanding (table VI) at Reserve city banks rose between 1954 and 1962 from 4.27 to 5.56 percent, or less than one-third. At country banks, where the average size of loan is relatively small and loan rates tend to be higher and less responsive to changes in credit conditions than at city banks, the increase was considerably less—from 5.36 to 6.21 percent, or a little under one-sixth. Although these increases reflect mainly the advance in market rates of interest over the period, they also stem in part from shifts within the loan portfolio toward higher yielding types, including consumer loans.

Returns on loans have not shown any appreciable advance during the current business upswing such as occurred in the two previous expansions of this 10-year period. In fact, at Reserve city banks, earning rates were appreciably lower in 1961 and 1962 than they had been in 1960, when they reflected the relatively high interest rate structure which had developed late in the previous business upswing. However, country bank rates, which also receded in 1961, rose in 1962 to a level slightly above the 1960 average.

Net interest and dividend return on investments (table VII), while fluctuating considerably from year to year mainly in reflection of capital gains and losses on securities transactions, also has moved upward over the period. The increase between 1954 and 1962 was about one-third at Reserve city banks and two-fifths at country banks, with the rate at country banks averaging slightly higher over the period than at city banks.

Total earning assets of both Reserve city and country banks showed larger relative increases between 1954 and 1963 than the average interest return on assets, and hence were a more importance factor in the growth in revenues. During this period, total loans and investments rose 53 percent at Reserve city banks and 72 percent at country banks.

Additional gains in revenues were realized as a result of the rise in the proportion of these assets held in the form of loans, which yield a much higher interest return than investments. Over the 10-year period, the ratio of loans to total loans and investments rose

from 48 to 65 percent at Reserve city banks and from 42 to 56 percent at country banks. This shift reflected in part the working down of holdings of U.S. Government securities to more normal levels after the unusually large acquisitions during World War II. Finally, banks added slightly to revenues over the period by increasing earning assets at the expense of their holdings of cash assets.

#### EXPENSES

Almost half of the \$5 billion increase in member bank operating expenses over the 1954-63 period was accounted for by interest paid on time deposits (table VIII). This item, which was relatively unimportant in 1954, had increased nearly sixfold by 1963, from \$494 to \$2,847 million. The rise was somewhat larger at Reserve city than at country banks, and reflected both an upward movement in rates paid on these deposits and rapid growth in total time and savings deposits.

Rates paid on time and savings deposits rose continuously over the period, with particularly large increases in 1957 and 1962 after the Federal Reserve had raised the ceilings on rates that member banks were permitted to pay on these deposits. City banks paid higher rates than country banks and they also raised their rates a little more than country banks between 1954 and 1963. The increase in average rates paid by both groups of banks, however, was between 150 and 160 percent, considerably more than the rise in average rate of return on earning assets.

Time and savings deposits rose much more rapidly during this period than demand deposits (table IX). Consequently, the ratio of time to total deposits increased substantially. Country banks have normally had a higher percentage of time to total deposits than city banks, but this margin narrowed considerably after 1961, when large city banks began to compete for corporate funds by issuing negotiable time certificates of deposit. Thus, the ratio of time to total deposits at Reserve city banks increased much more than at country banks between 1954 and 1963. In 1963, time and savings deposits accounted for 35 percent of all deposits at Reserve city banks and 44 percent at country banks.

Increased wages and salaries accounted for most of the remainder of the \$5 billion operating expense rise at member banks between 1954 and 1963. Mainly, this reflected the rise in wage and salary scales in industry generally.

#### THE MONEY SUPPLY GUIDELINE

I welcome the vigor with which an increasing number of academic economists, including two who have been serving on your staff, are now analyzing the statistical behavior of monetary magnitudes. The laudable aim of these investigations is to establish linkages, and stable relationships between the past behavior of monetary action and productive activity in the economy. I, myself, have recently tried to suggest ways in which the effects of monetary action on spending can be traced. The measurement problems are formidable and I regret to say that, in my judgment, we have not come nearly as close to achieving usable results as some of the academic people believe. Very little work

has been done on cyclical changes in the structure of money ownership or on the role of turnover as it affects the demand for money. Another major avenue for tracing the course of monetary action, changes in interest rates and credit conditions, has had even less professional quantitative analysis. Happily, there seems to be a growing interest among professional economists in extending our knowledge along both of these lines.

The money supply school of thought has been strongly influenced by the writing and teaching of Professor Friedman, whose views are familiar to you. A great deal of the empirical investigation has been inspired by his teaching but I would counsel against accepting the recommendations for action advanced by this school of thought.

Specifically, I don't believe that the way in which changes in money supply generate changes in economic activity has been sufficiently thought through and empirically tested to warrant the adoption of a fixed monetary policy rule based on the past behavior of the money supply. In fact, it has not even been established, in times like these, whether changes in money supply precede changes in economic activity, or vice versa, or whether money supply and economic activity move coincidentally. However helpful historical money supply patterns are to our understanding of past economic developments, converting this understanding into a rigid operating rule without the benefit of modifications that human judgment can provide to take account of the changing environment would be a hazardous step.

For example, had we at the beginning of 1961 adopted the Friedman proposal for a constant 4-percent rate of expansion in money supply, defined to include coin, currency, and privately held time and demand deposits in commercial banks, we would have added some \$14 billion less to credit supplies than actually was provided by the monetary policies followed by the Federal Reserve in these years. In contrast, the Federal Reserve could formulate monetary policy during the last 3 years by looking not only at the Friedman definition of the money supply, but also at the more logically defined money supply, at interest rate and credit conditions, and at the unfolding balance-of-payments situation.

I would like to return for a moment to some testimony that you have heard that changes in the money supply systematically precede fluctuations in general economic activity. A casual connection is imputed to this association; namely, that changes in the money supply cause the level of activity to change. From this imputation a policy prescription is derived which provides for continuous increases in the money supply at some optimal but invariant rate. I invite your attention to the attached chart which is presented to give you an opportunity to test Professor Brunner's technique for determining what causes what. In particular, you might want to guess which one of these series is the best predictor and, therefore, causal in Professor Brunner's analysis, of the others.<sup>1</sup>

<sup>1</sup> 5 Economic Time Series.

The chart of year-over-year percent changes contains the following series, although not in this sequence:

	<i>On chart</i>
1. Demand deposits adjusted and currency-----	D
2. Industrial production-----	E
3. Nonagricultural employment-----	A
4. Private nonfarm residential construction-----	C
5. New orders for durable goods-----	B

Shaded areas are recession periods as dated by National Bureau of Economic Research.

Percent Change over Corresponding Month  
of Preceding Year 1949-63  
5 Economic Time Series

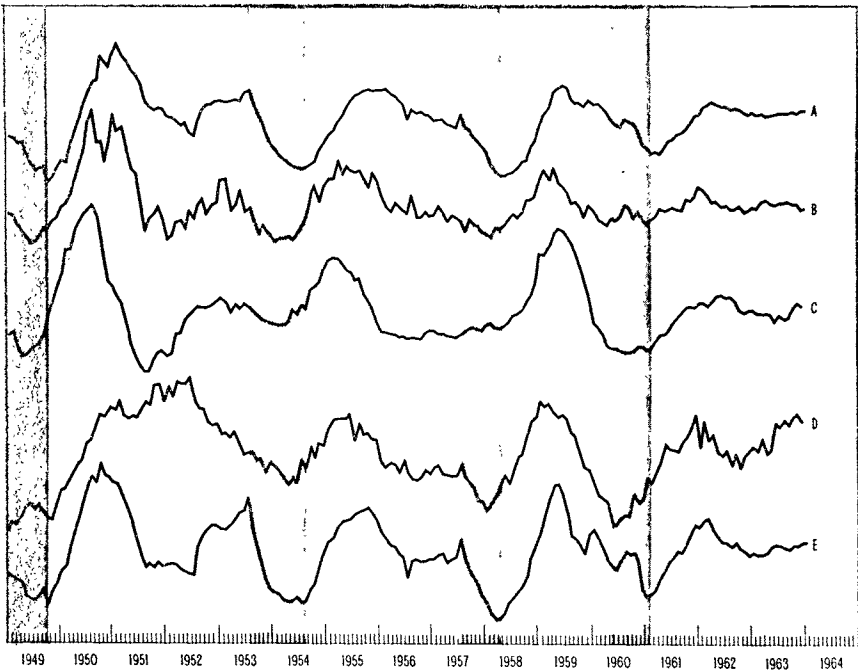

There is nothing in this type of statistical exercise that proves that money supply changes are truly leading economic activity and, of course, there is nothing in such a bare statistical exercise that proves or even argues persuasively that changes in the money supply cause fluctuations in economic activity.<sup>2</sup> I don't mean to deny that such a

<sup>2</sup>There is one other more or less technical qualification that should be observed in the presentation of cyclical lead and lag analysis. It is possible to create by simple arithmetic manipulations, leads and lags where none exist, except in terms of arithmetic relations having nothing to do with economic substance. One must always be very wary, therefore, in drawing conclusions produced by these manipulations where there is no satisfactory explanation given of the economic and institutional mechanics by which the leading series is supposed to influence the lagging series and no satisfactory explanation of the economic rationale of using the particular arithmetic manipulations.

To be more explicit. In any series that has a roughly cyclical movement, the movement of the rate of change of that series (that is to say the percentage change from one month or one quarter to the next) will also be cyclical—but with different timing—so that movements of the rate of change will lead the series itself. The exact amount of the lead and whether it is a constant lead or varies in different parts of the cycle—i.e., as between the upswing and the downswing—will depend on the particular pattern of movement of the original series, but the lead will average about one quarter the length of the cyclical movement. This means that if we have two series that have, say, the identical cyclical movement, then we can always show that either one of them leads the other by plotting the rate of change of the one it is desired to show leading against the original series of the other. Not only can either of two coincident series be converted to lead but by the same operation a slight lag can be converted to a lead. Therefore, unless very specific economic and institutional rationale are to be given for the particular arithmetic operations, they remain essentially primitive arithmetic exercises rather than economic analyses.

Just as the arithmetic operations of taking rates of change can shift the cyclical timing and change the impression of leads and lags, the arithmetic operation that Professor Brunner uses, of recording each month of a series in terms of its percentage change from the corresponding month of the previous year, can also change timing. The arithmetic relations in this case are somewhat more complicated than in the case of the rate-of-change calculations—depending on the length of the cycle, the existence of a trend, etc. But in series with rising trends, which is the case in the charts presented by Professor Brunner, the arithmetic operation itself can produce the appearance of leads. This, too, is a case where the ability to manipulate series arithmetically in such a way as to arrive

causal relationship exists. If it didn't there would be no argument for the existence of any type of monetary authority. I do argue, however, that the nature of the causal process is important, and that it has not been delineated and that I have seen nothing to demonstrate that the causal relationship is constant in degree and timing over economic cycles or over long periods when basic structural relationships in the economy have changed.

It appears to me that the arguments for abandoning discretionary money management in favor of a rigid formula is a surrender of the intellect and abandonment of the objectives of scientific inquiry. We are asked to cease grappling with the complexities of the modern economic world because the all too human minds of investigators seem inadequate to cope with the problems of such a world. Without in any way denigrating the importance of the credit and monetary-creation powers vested by the Congress in our present monetary authorities, I must disassociate myself from those who feel these powers can be employed without thought, judgment, discretion, and concern for the world as it is.

SELECTED EARNINGS DATA FOR MEMBER BANKS, BY CLASS OF BANK,<sup>1</sup> 1954-63, INCLUSIVE

[Reserve city category includes all Reserve city banks and prior to 1962, New York and Chicago central Reserve city banks]

TABLE I.—*Gross revenue*  
[Millions of dollars]

Year	Reserve city	Country	Year	Reserve city	Country
1954.....	2, 857	1, 969	1959.....	4, 819	3, 256
1955.....	3, 170	2, 173	1960.....	5, 298	3, 630
1956.....	3, 659	2, 419	1961.....	5, 429	3, 788
1957.....	4, 074	2, 697	1962.....	5, 952	4, 202
1958.....	4, 271	2, 856	1963 <sup>1</sup> .....	6, 504	4, 630

<sup>1</sup> Data for 1963 partly estimated.

at leads cannot by itself be used to establish even a presumption of the nature of the economic relationship involved.

I might say parenthetically that Professor Brunner nowhere indicates the economic rationale for working in terms of year-over-year changes, the movements and magnitudes of which depend not only on what is happening currently but also on what happened a year ago. It is, therefore, a quite awkward technique to use in evaluation of current happenings.

Professor Brunner, I am sure, would not take exception to this raising of the question of the logic and relevance of certain aspects of his procedures, he himself applies the most rigorous standards of logic and relevance to his evaluation of other economists' work. I have recently heard him express himself as astonished at some of his academic colleagues for presenting arithmetic relationships without demonstrating their relevance to economic and policy issues through an analysis of the economic and institutional mechanisms involved.

TABLE II.—*Net current earnings before income taxes*

[Millions of dollars]

Year	Reserve city	Country	Year	Reserve city	Country
1954.....	1, 153	674	1959.....	1, 922	1, 013
1955.....	1, 313	764	1960.....	2, 162	1, 111
1956.....	1, 558	840	1961.....	2, 058	1, 085
1957.....	1, 679	870	1962.....	1, 984	1, 128
1958.....	1, 670	840	1963 <sup>1</sup> .....	2, 040	1, 192

<sup>1</sup> Data for 1963 partly estimated.TABLE III.—*Net income after taxes*

[Millions of dollars]

Year	Reserve city	Country	Year	Reserve city	Country
1954.....	669	427	1959.....	805	452
1955.....	629	357	1960.....	1, 061	628
1956.....	662	364	1961.....	1, 083	629
1957.....	750	419	1962.....	1, 035	660
1958.....	933	524	1963 <sup>1</sup> .....	1, 142	677

<sup>1</sup> Data for 1963 partly estimated.TABLE IV.—*Total capital accounts*

[Millions of dollars]

Year	Reserve city	Country	Year	Reserve city	Country
1954.....	7, 362	4, 362	1959.....	9, 993	5, 905
1955.....	7, 838	4, 661	1960.....	10, 455	6, 366
1956.....	8, 325	4, 946	1961.....	11, 071	6, 846
1957.....	8, 851	5, 256	1962.....	11, 694	7, 372
1958.....	9, 503	5, 583	1963 <sup>1</sup> .....	12, 325	7, 941

<sup>1</sup> Data for 1963 partly estimated.

TABLE V.—*Net income as a percentage of total capital accounts*

[Millions of dollars]

Year	Reserve city	Country	Year	Reserve city	Country
1954.....	9.1	9.8	1959.....	8.1	7.7
1955.....	8.0	7.7	1960.....	10.2	9.9
1956.....	8.0	7.4	1961.....	9.8	9.2
1957.....	8.5	8.0	1962.....	8.9	8.9
1958.....	9.8	9.4	1963 <sup>1</sup> .....	9.3	8.5

<sup>1</sup> Data for 1963 partly estimated.TABLE VI.—*Net interest return on loans as a percentage of total loans*<sup>1</sup>

[Millions of dollars]

Year	Reserve city	Country	Year	Reserve city	Country
1954.....	4.27	5.36	1959.....	5.35	6.06
1955.....	4.30	5.47	1960.....	5.93	6.13
1956.....	4.57	5.54	1961.....	5.44	6.10
1957.....	4.96	5.80	1962.....	5.56	6.21
1958.....	5.00	5.83	1963.....	( <sup>2</sup> )	( <sup>2</sup> )

<sup>1</sup> After nonoperating losses and chargeoffs, recoveries, and profits, but not including transfers to and from valuation reserves.<sup>2</sup> Not available.TABLE VII.—*Net interest and dividend return on securities as a percentage of total securities*<sup>1</sup>

[Millions of dollars]

Year	Reserve city	Country	Year	Reserve city	Country
1954.....	2.50	2.40	1959.....	1.18	2.05
1955.....	1.76	1.90	1960.....	3.13	3.21
1956.....	1.65	1.93	1961.....	3.67	3.36
1957.....	2.09	2.27	1962.....	3.35	3.34
1958.....	3.48	3.04	1963.....	( <sup>2</sup> )	( <sup>2</sup> )

<sup>1</sup> After nonoperating losses and chargeoffs, recoveries, and profits, but not including transfers to and from valuation reserves.<sup>2</sup> Not available.

TABLE VIII.—*Interest paid on time deposits as a percentage of total time deposits*

Year	Reserve city	Country	Year	Reserve city	Country
1954.....	1.34	1.25	1959.....	2.44	2.28
1955.....	1.39	1.33	1960.....	2.63	2.53
1956.....	1.62	1.53	1961.....	2.80	2.65
1957.....	2.18	1.97	1962.....	3.39	3.04
1958.....	2.26	2.14	1963 <sup>1</sup> .....	3.45	3.18

<sup>1</sup> Data for 1963 partly estimated.

TABLE IX.—*Time deposits as a percentage of total deposits*

Year	Reserve city	Country	Year	Reserve city	Country
1954.....	21.4	32.6	1959.....	26.4	37.3
1955.....	21.8	32.5	1960.....	26.2	38.7
1956.....	22.0	32.7	1961.....	28.7	40.0
1957.....	23.5	34.4	1962.....	31.7	41.6
1958.....	25.9	36.5	1963 <sup>1</sup> .....	35.3	43.5

<sup>1</sup> Data for 1963 partly estimated.

The CHAIRMAN. Thank you very much, Governor Mitchell.  
Now, Governor Daane, you may proceed in your own way, sir.

#### STATEMENT OF HON. J. DEWEY DAANE, MEMBER OF THE BOARD OF GOVERNORS, FEDERAL RESERVE SYSTEM

MR. DAANE. Mr. Chairman and members of the committee, as you stated, Mr. Chairman, I am the newest member of the Board of Governors, having been appointed by President Kennedy shortly before his death and having been sworn in last November 29. I am, however, not new in terms of intimate acquaintance with the Federal Reserve; in fact, excepting a relatively short period in the Treasury Department, I will this spring be rounding out 25 years of continuous service in the System. Nor am I exactly a stranger to inquiries such as this into the workings of the Federal Reserve System. I well remember one of my earliest substantive tasks after joining the Research Department of the Federal Reserve Bank of Richmond in early 1939 was to try to assist the President of that bank in preparing his replies to questions addressed to him, and to other System officials, by Senator Wagner,



then chairman of the Senate Banking and Currency Committee. These questions were concerned with many of the same issues, such as that of the most appropriate role of the Secretary of the Treasury in relation to our central banking system, as are again raised by the proposed bills being considered by this committee. I also participated in the appraisals conducted within the Federal Reserve as part of the more recent congressional inquiries—in 1949 under the chairmanship of Senator Douglas, and in 1952 the even more extensive review conducted under your chairmanship.

It is my sincere hope that the careful review and findings in your 1952 committee report will not be passed over in a desire to make change in the Federal Reserve System for the sake of change. Over the past 25 years I have at firsthand watched the System adapt, as it should always be ready to do, to the constantly changing financial environment in which it operates, but in the past decade certainly nothing has changed the basic principles of central bank action nor its need for some sort of insulation from partisan political pressures in order to serve most effectively the public interest—principles and needs which were so well recognized and underscored in what is known as the Patman committee report.

From the background of this experience and in order to avoid repeating testimony you have received from other Federal Reserve witnesses concerning the bills before you, let me comment generally about four of them: H.R. 3783, to retire Federal Reserve bank stock; H.R. 9631, to revamp the structure of the Federal Reserve System; H.R. 9685, to require the System to pay over to the Treasury its earnings on Government obligations and seek appropriations to meet its expenses; and H.R. 9749, to require the Federal Reserve to use open market operations to support prices on Government obligations so as to assure yields of not more than  $4\frac{1}{4}$  percent.

Taken together, these bills would, I believe, tend to decrease the contribution that monetary policy can make toward achievement of a stronger economy. In part, the bills would run the risk of diverting monetary policy from its primary goal of meeting the needs of the economy as a whole to one of simply facilitating the management of the public debt. They would take from the presidents of the Federal Reserve banks their most important function—participation in the formulation of monetary policy. And they would weaken the capacity of the System to maintain, year in and year out, the degree of independence from the budget and appropriations process which is needed to assure the long lasting value of the dollar against the short-lived pressures of budgetary developments. In my judgment these steps would inevitably reduce the strength and ability of the System to serve the public interest.

To the extent that I have been able to follow these hearings, I gather that these steps are advocated partly from fears of some that the Federal Reserve might one day attempt to block Government programs approved by the electorate, partly from a suspicion that Federal Reserve bank presidents are banker dominated, and partly from dissatisfaction with the process of monetary policy formulation.

Taking a closer look at these three main threads in the current inquiry, namely, the relationship and role of the Federal Reserve within the framework of Government, the allegation of banker domi-

nation, and the monetary policy process, it will come as no surprise to you that I do not find much to agree with in these bills.

First of all, whatever the theoretical possibilities may be of a basic conflict between the Federal Reserve and the administration, the fact is that the relationship has been and is a harmonious one. In announcing his decision to reappoint Mr. Martin as Chairman of the Board of Governors, President Kennedy described the relationship in these terms:

As Chairman of the Board of Governors, Mr. Martin has cooperated effectively in the economic policies of this administration and I look forward to a constructive working relationship in the years ahead.

As you know, the Federal Reserve System is a fully independent agency of the U.S. Government but it is essential that there exist a relationship of mutual confidence and cooperation between the Federal Reserve, the economic agencies of the administration, including especially the Secretary of the Treasury, and the President.

Mr. Martin has my full confidence and I look forward to continuing to work with him and his colleagues on the Board in the interest of a strong U.S. economy.

The Federal Reserve System, after all, is a public institution. Its policies evolve within the framework of general Government policies. The primary goals of monetary policy are identical to those of Government economic policy; we, too, are governed by the Employment Act of 1946. Thus the principal objective of monetary policy is to make a maximum contribution to the attainment of the national economic goals of an adequate rate of growth, sustained high levels of production and employment, and reasonable price stability. We, too, are seeking maximum employment, production, and purchasing power.

In recent years I have been in the administration as a part of the Treasury Department and its policies, and I have also previously been on the other side of the fence as a part of the Federal Reserve and its policies. Both institutions clearly have been working toward the same dual objectives, namely, the attainment of a satisfactory rate of growth with maximum employment, and the elimination of a serious balance-of-payments problem.

From my experience both at the Treasury and the Federal Reserve it may be helpful to you if I comment somewhat further on the effective working relationships which now exist between these two agencies. There are, of course, shades of difference in view between the Federal Reserve System and the Treasury from time to time, but the same thing may be said within either the Federal Reserve or the Treasury, and in my judgment these differences are healthy. The fact of the matter is, that in the formulation of monetary policy, the Federal Reserve is as responsive to the needs of Government finance as it either should be or can be, and the Treasury, in turn, is acutely conscious of the problems which its debt management operations create for the monetary authorities. I am quite certain from my experience on both sides of the fence that it would be unreasonable to hope for any significant improvement in the technical coordination of monetary policy and debt management through the consolidation of these functions under a single head.

This then leaves as the only significant question whether the public interest would be better served by placing the formulation of monetary

policy under the domination or the detailed direction of the Secretary of the Treasury. I am convinced that this would be most unfortunate—not just for the Federal Reserve and for the Treasury in the first instance, but more importantly for the Government and the people of the country in the longer run. Both the Treasury and Federal Reserve naturally reflect two different viewpoints related to their own particular responsibilities which need to be fully reflected in their respective spheres. These responsibilities should not be centralized. In my view, it is greatly to the advantage of the Treasury that it is able to make its debt management decisions in the light of a monetary policy which is determined independently by men of high qualifications, rather than place itself in the dilemma of having to generate both monetary and debt management policies simultaneously, which would require it somehow to insulate its thinking on monetary policy in some way from its obvious and desirable zeal to finance the debt as economically as possible. I have seen at first hand in other countries the dangers involved in downgrading or subordinating monetary policy.

Again, from my own experience in serving two Secretaries of the Treasury, both of whom were able and conscientious public servants but already overburdened in terms of the tremendous responsibilities thrust upon them, I question whether as a practical matter it would be feasible for the Secretary of the Treasury to participate fully in the formulation of monetary policy. Some alternative involving delegation of authority would have to be developed and I do not believe this would be desirable.

The present arrangements for the coordination of monetary policy with the other economic policies of Government are, in fact, very effective. The changes that are proposed in these bills seem to me to offer little hope for improvement and to run the risk of serious mischief.

A second main thread in the current inquiry both puzzles and, I must confess, saddens me. It is the implication regarding the public service motivation of System officials, and specifically of the Presidents and Directors of the Reserve banks. To me the Federal Reserve, no less than the Treasury, stands for all that is best in purposeful public service. In fact, I believe that much of the underlying strength of the System derives from the sense of constructive purpose, and the spirit of public service, which permeates all parts of the System. In my judgment anything that is destructive of that purpose and spirit, by innuendo or outright action, would be inimical to the public interest.

I speak with feeling on this point because in my lifetime I have never known a more selfless public servant than the President of the Federal Reserve Bank of Richmond, Mr. Hugh Leach, with whom I worked for 20 years, and who I believe was typical of the Federal Reserve Presidents in terms of his objectivity and dedication to the public interest, and complete freedom from any banker influence. His devotion to public duty was recognized not only in the immediate financial community but throughout the State of Virginia and the Fifth District. I thus find that any charge of banker domination is inconceivable—I also find it difficult to visualize the System obtaining the services of men of this quality if they are prohibited from sharing the responsibility for the formulation of policy.

The third and final thread in the inquiry on which I would like to comment briefly is the apparent criticism of the System, on the one hand, for not adopting the single criterion of the stock of money as its sole objective and measure, and, on the other hand, for being guided in the formulation of policy too much by short-run money market factors, rather than more basic longer term economic and financial developments. Neither criticism is justified. As to those who would put money stock rigidly above all else, I think one of your preceding academic witnesses, Professor Samuelson, gave eloquent answer. Making the stock of money paramount and the sole objective and measure of monetary policy would be indeed a retrogression. It would ignore the fact that there is no optimum money supply nor sacrosanct rate of money supply growth—that money supply, in fact, may be permissive rather than causative.

The other charge, that of money market myopia, displays a lack of understanding of the policy formulation process and of the System's operations in the market. The policy formulation process does not simply focus on the day-to-day money market developments, and there has certainly been no overemphasis on such short-term factors in the setting of monetary policy. Let me illustrate my point by describing the economic intelligence we currently receive before and at a typical Open Market Committee meeting. It includes a 30- to 40-page written document and a total of about 2 hours of oral briefing, both of which concern such subjects as production and employment, incomes, trade, wages, costs, prices, construction, agriculture, credit, capital, money, savings, taxes, and the balance of payments. This list of briefing subjects certainly does not suggest an overemphasis on short-term money-market factors in the discussions underlying the process of arriving at a decision regarding an appropriate monetary policy at any specific time.

Nor is one single guide to operations adopted in the policy process as has been alleged—the weaknesses of the various operational guides, such as free reserves, member bank borrowings, and various short-term interest rates are well recognized throughout the System. Those who criticize use of any of these operational guides fail to understand the distinction between the System's defensive and dynamic operations in the market. Because the purpose of defensive operations is to offset the effect on the level of reserves of various market factors they do not ipso facto constitute changes in the reserve level or in monetary policy. On the contrary, they simply neutralize the effects on reserves of these other factors, thereby keeping the road clear for those dynamic operations which are designed to achieve changes in the level of reserves in the light of longer run economic and financial objectives.

Two concluding observations relating to the main threads of this inquiry may be relevant.

First, as to the underlying question of the System's sense of responsibility within the Government there is obviously a clear need for the Federal Reserve to be closely attuned to the economic thinking of Government, and this is being accomplished by various arrangements at the technical and policy levels. Each President of the United States can be expected to develop informally his own particular method of communication within the Government, but whatever the variation in method the System's awareness and sensitivity in its relations

with the executive branch are assured. Correspondingly, continuing inquiries of the sort being undertaken by this committee assures that the System is at all times closely attuned to, and responsible to, the Congress as well.

Finally, coordinated monetary and debt-management policies in the recent past have succeeded in assisting our balance of payments while accommodating record levels of borrowings at home—with an interest rate pattern not that suggested by bankers but one unique for a sustained expansion period. The impressive results seem to me to provide significant commentary on all three issues posed in this current inquiry.

Thank you, Mr. Chairman.

The CHAIRMAN. Thank you, sir.

I will forgo asking questions myself at this time until the other members have had an opportunity.

Mr. REUSS?

Mr. REUSS. Thank you, Mr. Chairman.

Our Republican colleagues on the committee must be laughing this morning, because they will remember, as I do, the election of 1960 when we Democrats attacked the existing Federal Reserve for its monetary policy, and attacked it with such vigor that foreign central bankers started a run on our gold supply in September and October of 1960, and here we have the two Democratic appointed members of the Federal Reserve System who have out-Martined Bill Martin in their testimony this morning. I think the laugh is on us.

Mr. WIDNALL. Will the gentleman yield?

Mr. REUSS. Sure.

Mr. WIDNALL. I am not laughing. I am just pleased that it is now being brought to the attention of the American public what bipartisan appointments can mean as far as the Federal Reserve System is concerned, and also that people with a background that goes far beyond a banking background can contribute their own evaluation of the circumstances before them. And one further thing:

I do not recall that the then Senator Kennedy campaigned for the Presidency on this issue. Some Democrats may have made these statements in the course of the campaign, but I do not believe this was a campaign issue.

Mr. REUSS. Oh, yes, he was properly critical of Federal Reserve policy in the recent past and thought it played quite a role, as I did, in contributing to the recessions of 1957 and 1960.

But, to ask some questions: Mr. Mitchell, you indicate in your testimony that you would not change the present composition of the Open Market Committee, and you give as a reason that regional representation from the five presidents of the Federal Reserve banks is a constructive contribution to the present Open Market Committee.

Could not the Open Market Committee, if it were reconstituted to consist of the seven publicly appointed members of the Federal Reserve Board, get that regional advice if it set up as an advisory committee all or part of the 12 Federal Reserve bank presidents?

Mr. MITCHELL. Yes, it could get the advice. I think there is a little difference between receiving advice from somebody else and being able to implement your judgment and advice by having the power to vote on a policy issue.

Mr. DAANE. Could I add a comment on that, Mr. Chairman?

The CHAIRMAN. Yes.

Mr. DAANE. I would just like to say that in my own experience, as I indicated, I worked closely with the president of one of the Reserve banks, for over 20 years actually, and was constantly advising him with respect to monetary policy formulation.

But I find in even the very short period of time that I have been at the Board there is a considerable difference between the degree of responsibility that you share when you simply are advising someone and when you are actually on the firing line with a vote involved in the policy process.

Mr. REUSS. Is that the president of the Federal Reserve bank? He was appointed by the bank rather than the President of the United States; was he not?

Mr. DAANE. He was appointed by the bank's directors, but he was approved by the Board of Governors, and, of course, he took an oath when he served on a rotating basis as a member of the Open Market Committee.

Mr. REUSS. Until and unless he became a member of the Federal Open Market Committee; if, in short, he were one of the seven regional bank presidents who was not a member of the Federal Reserve Open Market Committee, he did not take an oath of office to the United States; did he?

Mr. DAANE. He did not, Mr. Reuss. On the other hand, as I tried to say in my statement, the sense of public service was still present in the interim periods, when he was not taking an oath. He was kept abreast of and a part of the policy process.

Mr. REUSS. Well, I just brought this out because you seemed to make a great point of the effect of taking an oath, and I wished the record to show that 7 of the 12 regional bank presidents do not take an oath at all until and unless they are appointed as members of the Open Market Committee.

Mr. DAANE. I do not think that the oath taking per se is the really significant difference. His sense of purpose would have been the same but his sense of responsibility would have differed if he were excluded from the direct responsibility from time to time for the policy formulation itself.

Mr. REUSS. Mr. Mitchell, you come to grips with your fellow Chicagoan, Professor Friedman, who testified here yesterday along the lines that he has advanced in recent years, that he cannot make head nor tail out of Federal Reserve policy; that while he does not know that you always hurt the economy very much; he thinks that when you do it good it is accidental; and that it would be much better if you set as your target the creation of annual increments to the money supply of around 4 percent, which would suit him fine, and let it go at that.

You attempt to refute this by setting forth a chart which, as I look at it, shows that the wobbles in the money supply do seem to wobble in some sort of harmony with the wobbles in industrial production and employment and various other factors, and I think your point is which causes which.

Does the money supply adjust to changes in gross national product, or is it vice versa?

Mr. MITCHELL. Yes, precisely; and, actually, there are other series that are better indicators than the money supply.

Mr. REUSS. Well, while I want to make it clear that I am by no means a "Friedmanite" and am not prepared to buy lock, stock, and barrel his proposition, nevertheless, I am not persuaded that you refuted him this morning, and I would like to pursue this a bit with you.

It is a fact, is it not, that the Federal Reserve System can control the money supply whereas it cannot, nor can any other governmental agency except very, very indirectly, control industrial production and employment and gross national product?

Mr. MITCHELL. Well—

Mr. REUSS. That is true; is it not?

Mr. MITCHELL. The point—

Mr. REUSS. I hear "No" from the minority side. What about this, Mr. Mitchell?

You can't control the money supply?

Mr. MITCHELL. Well, let me say first that the purpose or the objective of both fiscal and monetary policy is to effect the growth of the economy and try to moderate economic fluctuations. The whole discussion of public policy, as it relates to monetary policy and fiscal policy, is to effect the rate of growth and to minimize cyclical fluctuation.

So we are trying to effect the thing you say we cannot effect with our policies.

Mr. REUSS. Yes, in your wildest, most euphoric moment, you do not claim that you can, all by yourself, bring about full employment without inflation?

Mr. MITCHELL. All I am saying, Mr. Reuss, is that the point about fiscal and monetary policy is that it is attempting to do the very thing that you say it cannot do.

Mr. REUSS. Well, you are misconstruing what I said.

I am not talking about fiscal policy, taxes, and spending. I was talking about monetary policy.

Mr. MITCHELL. Well, I think monetary policy can make a contribution in this direction; yes.

Mr. REUSS. Agreed. Is it not also true that monetary policy can control the money supply?

Whether that, in turn, will produce the beneficent results on employment and production that we all want is another matter, but you can control the money supply, can you not?

Mr. MITCHELL. Well, it is at times difficult. The money supply grows in a very lumpy fashion, and this is because the initial action which we take, in providing reserves, does require a response from the banking system and from individuals—

Mr. REUSS. But the banking system is either going to make loans or buy investments—

Mr. MITCHELL. You can eventually do something with the money supply but in the course of doing this you may cause some things to happen that you believe are undesirable and, therefore, the goal of just making the money supply move, if followed relentlessly, could have an impact upon credit conditions and expectations that might be totally undesirable.

Mr. REUSS. Yes, but you must answer my question, which was not whether it is good to make the—

Mr. MITCHELL. Oh, I think I am answering your question.

Mr. REUSS (continuing). Not whether it is good to make changes in the money supply the sole goal of monetary policy. There you have indicated you disagreed with Friedman, who says it is, but my question is whether you can—

Mr. MITCHELL. Ignoring all other consequences, absolutely.

Mr. REUSS (continuing). Change the money supply. No doubt about that?

Mr. MITCHELL. Ignoring all other consequences.

Mr. REUSS. Well, Mr. Chairman, I did have one more question, but my time has expired.

The CHAIRMAN. Suppose we bear with him to ask that other question, Mr. Widnall?

Mr. REUSS. Well, thank you very much, but I can wait.

The CHAIRMAN. Mr. Widnall?

Mr. WIDNALL. Thank you, Mr. Chairman.

Mr. Daane—is that the way you pronounce it?

Mr. DAANE. Yes, "Dane," as if it were one "a."

Mr. WIDNALL. I particularly concur with the statement that you made at the top of page 7 as to the implication regarding the public service motivation of system officials in this investigation. I am very pleased that you brought that out.

Would you, for the record, give your own background before you took this present position, by way of education and business and experience?

Mr. DAANE. Yes. I joined the Federal Reserve bank at Richmond, in the Research Department, in June of 1939 and after being with them for roughly 8 years—I graduated prior to joining the bank, incidentally, from Duke University, with an A.B. degree.

After working at the Federal Reserve bank at Richmond for roughly 8 years, on leave of absence for 15 months I obtained my master's, and subsequently my doctor's degrees at Harvard, returning to the Federal Reserve Bank of Richmond as their monetary economist, on January 1, 1947, becoming subsequently an assistant vice president and vice president and director of their Research Department.

I transferred in 1960 to the Federal Reserve Bank of Minneapolis, as vice president and economic adviser to that bank and its president, and was then loaned by that bank to the Treasury Department to be Assistant to the Secretary in June of 1960, Assistant to the Secretary for debt management.

I continued on in that capacity until the fall of 1961 when I was appointed Deputy Under Secretary for Monetary Affairs, and at that point terminated my leave of absence with the Federal Reserve Bank of Minneapolis.

I was in that position until the end of this past November when I was appointed a member of the Board.

Mr. WIDNALL. Thank you, Mr. Daane.

Now, earlier in the hearings there was a great deal of emphasis placed on the obligation of the Federal Reserve System to keep in mind the full obligation to observe what was in the full Employment Act of 1946 in making their decisions.

As I understand from your testimony, your ability to meet that obligation will be seriously circumscribed if the pending legislation is enacted. Is that not so?



Mr. DAANE. Yes, I believe that is so particularly with respect to the very unique contribution in the formulation of policy that comes about from regional representation and, more importantly, perhaps, from the submerging of the monetary policy process to the exigencies of Government finance which could result from the bills that are before you.

Mr. WIDNALL. Now, one further question to you:

On page 6, you said: "I have seen at first hand in other countries the dangers involved in downgrading or subordinating monetary policy."

Could you amplify that further by giving an—

Mr. DAANE. An illustration?

Mr. WIDNALL (continuing). An illustration of your own experience?

Mr. DAANE. Yes, I certainly could.

I went down in 1950 as the head of a fiscal mission to the Republic of Paraguay.

I was loaned at that point by the Federal Reserve Bank of Richmond to the International Monetary Fund. I was supposed to work primarily on Paraguay's budget problems.

When I arrived in Paraguay I sat down with their comptroller and budget director and I noticed that they had a budget that was almost in balance, about, I would say a 5-percent deficit or something less, but that about a third or more of their revenues were coming from *recursos varios*, "miscellaneous taxes."

I recall I asked the comptroller what are these miscellaneous taxes that produce so much revenue, and bring the budget back into balance?

We were looking at the budget for the next fiscal year. And he laughed and he said, "This is simply central bank credit from the Bank of Paraguay," and so their deficit was not in the neighborhood of 5 percent but something in the neighborhood of 50 percent because they had this direct access to central bank credit.

The effect of this, which is the point of my reference in the statement, is that they had at the time that I went down there in 1950 an official rate of exchange of about 8 guaranies to the dollar. The guarani was worth roughly 12.5 cents.

While I was there the effective rate in the black market went up to some 25 guaranies to the dollar or about 4 cents and in the very close intervening period after that it slipped to something like, I believe, just a fraction of 1 cent, and the real reason for this was very simple.

At the close of a day, when the Minister of Finance wanted to pay his bills, he could resort directly to a draft on the Bank of Paraguay. Well, this is an extreme case, admittedly, of a small country in Latin America.

But the principle is precisely the same, and it has happened in other countries as well.

Mr. WIDNALL. Thank you.

Mr. Mitchell, what effect do you anticipate the recent act of the Bank of England, in raising its discount rate to 5 percent, will have on the American monetary market?

Mr. MITCHELL. Well, I think the preliminary indication is that the rate effect will not be very significant but at this time I think it is impossible to say what might happen.

Mr. WIDNALL. Is there a potential difference between the short-term effect and the long-term effect?

Mr. MITCHELL. Well, I would not characterize it that way. I would say that at the moment the people whose behavior will be altered by this change in bank rate have not decided which way or in what way to change their investment policies.

Until they do, we will not really know what the effect is.

Mr. WIDNALL. It could lead to a flight of funds from the United States to England, though, could it not?

Mr. MITCHELL. Well, it could lead to some short-term flows inspired by interest differentials to England, yes, although I think that this is not going to happen on a very large scale.

Mr. WIDNALL. Mr. Mitchell, would you also, for the record, give your own background just as Mr. Daane has done?

Mr. MITCHELL. Before I worked for the Federal Reserve System I was a tax administrator in the State of Illinois, from 1932 to 1944. In 1944 I came with the Federal Reserve System and I was with the Federal Reserve Bank of Chicago until I came down here 2½ years ago. But during the period I was connected with the Federal Reserve Bank of Chicago, I was on leave of absence to work for Governor Stevenson, as his director of finance.

That was for 2½ years.

Mr. WIDNALL. I would like a specific answer from both of you as to whether or not you feel that the composition of the Federal Reserve Board of Directors is such that it is banker dominated.

Mr. Daane?

Mr. DAANE. I am sorry, Mr. Widnall, does your question relate to the boards of directors of the Federal Reserve banks, the Board of Governors?

Mr. WIDNALL. The Board of Governors.

Mr. DAANE. No; I certainly do not believe that it is banker-dominated in any sense whatsoever.

I feel that this is a charge that is not true in any way, shape, form or fashion. I try to point this out in my statement with respect to the presidents of the Reserve banks, but it is equally applicable to the members of the Board of Governors.

Mr. WIDNALL. Would you care to comment on that, Mr. Mitchell?

Mr. MITCHELL. I do not think it is banker dominated. I think there are lots of relationships between the Federal Reserve and bankers because they are both in essentially the same business and as so they speak a common language in a great many respects, and the Federal Reserve engages in supervisory operations which bring them in close contact with the bankers.

And I think this gives rise to some speculation that the banks tend to dominate the Federal Reserve, but I do not think this is so.

Mr. WIDNALL. Well, do you believe that the Board itself is dominated by the Chairman?

Mr. MITCHELL. Well, I think the Chairman is more than just one member of the Board, yes, but when you say "dominated" I do not think he dominates me and I do not think he wants to.

Mr. WIDNALL. Mr. Daane?

Mr. DAANE. I will comment again simply supporting Governor Mitchell's comment, in the negative to your question, that the Chairman has made it very clear that he expects us to, and in fact we do, vote our own convictions in the interest of the some 200 million people in this country. Even in the short time that I have been on the Board

I have in, I believe, at least two instances involving bank mergers publicly dissented from a majority opinion of the Board in which the Chairman concurred.

Mr. WIDNALL. Thank you very much.

The CHAIRMAN. Mr. Hanna?

Mr. HANNA. Thank you, Mr. Chairman.

As one member of this committee, I certainly want it to be clear that as far as my participation here is concerned I have the feeling, and I hope it is correct, that the inquiry is directed more to the structure and organization of the Federal Reserve than it is to any personalities or individuals.

Certainly, I have not felt, and perhaps I am not as sensitive as some, that the inquiry is directed toward the personalities or their abilities or their character, and I hope that that feeling I have is true.

However, talking in terms of specific structure, I think that maybe your situation is not different from mine. I came here as a new member of Congress, just as you gentlemen have been new members of the Board.

I do not find myself dominated by the chairman of this committee, but I do find myself dominated by the structure of Congress.

And I wish to heaven something could be done to change the structure, and I think that is what we are trying to talk to you gentlemen about.

Now, I do not know whether you want to comment on whether you are not dominated by the structure of the body in which you serve, but I suspect you are. Talking about that then, and keeping our eye on the doughnut and not on the hole, I would ask you this question: Do either of you feel that the Board would be seriously impaired in its quality or ability to operate if the terms of the Board members were made to be 6 years, the existing term?

Mr. MITCHELL, would you care to comment on that?

Mr. MITCHELL. In my statement I suggested that as a lower limit.

Mr. HANNA. Mr. Daane, would you care to comment on that?

Mr. DAANE. I would, I believe, go along with Governor Mitchell, that perhaps a 6-year term as a lower limit with eligibility for—

Mr. HANNA. A second term?

Mr. DAANE. Pardon?

Mr. HANNA. With eligibility for reappointment?

Mr. DAANE. With eligibility for reappointment. I rather feel from observation over many years that the experience acquired with an institution such as the Federal Reserve is an invaluable asset, but I don't see anything sacrosanct about that experience having to be in the form of a fixed term of 14 years. I would like to see the people that are experienced and capable and contributing have an opportunity to have their services retained within the system.

Mr. HANNA. However, I don't know whether I would be correct in assuming that you would not take a position that the pool of resources of the United States is so limited that we couldn't get highly qualified persons for this Board, in the event that we did place it at 6 years with the right to reappointment.

Mr. DAANE. No. All I am saying is, I think there would be considerable advantage in retaining the option for reappointment to make use of valuable experience.

Mr. HANNA. Yes.

Mr. DAANE. I may be a little biased on this, since I had most of my working lifetime in the System.

Mr. HANNA. Yes, I had rather felt that, and I noted that both of you gentlemen have come up through the System, and I am taking that into account as I evaluate what you have to say.

Would either of you care to comment on this? Do you think that it would in any way seriously impair the operation of the Board, if each incoming President had the power to appoint the Chairman either from members of the Board or from some other place in society, if he felt the man qualified to operate as Chairman? Do you think this would seriously impair the operation, Mr. Mitchell?

Mr. MITCHELL. No, I do not.

Mr. HANNA. Mr. Daane?

Mr. DAANE. No, nor do I. I believe in fact that the Chairman has testified favorably toward this and I find it difficult to conceive of the President's hands being tied in the appointment of the Chairman of the Federal Reserve.

Mr. HANNA. Thank you.

The CHAIRMAN. Mr. Hanna, will you yield briefly, please?

Mr. HANNA. Yes, Mr. Chairman.

The CHAIRMAN. Mr. Martin testified that he would be in favor of the 4 years being served along with the President, that is correct, but he did not say that he would be willing to give the President of the United States freedom of choice to appoint anyone that he wanted to appoint.

Under existing law he is compelled to appoint one of seven members to the Federal Reserve Board under a statute. But Mr. Martin—do you ever remember him having said that he would give the President freedom of choice?

Mr. DAANE. I assumed that when he called for a coterminous term of the Chairman and the President, he in effect was thinking that this would free the President's hands to appoint the man that he wished.

The CHAIRMAN. If the law would remain on the statute books, he would have to appoint one of seven. Excuse me.

Mr. HANNA. That is all right, Mr. Chairman. I hope the record will show that I wasn't dominated by your request to yield. It would have been granted to any other member.

Speaking in terms of the interest rates on deposits, do you think that we would in any way seriously impair the monetary policy of the United States in the operation of the banks if we allowed interest rates to be paid on demand deposits, Mr. Daane?

Mr. DAANE. Yes, I would like to address myself to this question. This I do feel would be a disadvantageous step from the standpoint of the economy, from the standpoint of the system and the strength of our whole monetary mechanism.

I believe the best answer on this perhaps is that of the President's Committee on Financial Institutions, which pointed out the two principal problems involved, if we were to move over to a payment of interest on demand deposits. First, this would inevitably put the smaller banks at a definite disadvantage. It would accelerate whatever disadvantage the small banks now have, and would tend to cause the deposits to gravitate to the larger banks.

Secondly, as this Committee report points out, a report signed by all of the presidentially appointed members, including the Secretary of the Treasury and the Chairman of the President's Council, the probability is very high that this would result in banks reaching out for unsound assets in order to support the additional costs.

I think Governor Mitchell has amply demonstrated what is happening to earnings and expenses over the past decade, and if you threw this cost in on top, my conclusion is that it would first of all be a definite detriment to the smaller banks and second, would be a threat to the soundness of our banking system.

Mr. HANNA. Mr. Mitchell, do you care to comment on that?

Mr. MITCHELL. Well, I think I would go pretty slow in making a change of this kind. I tend to agree with what Governor Daane says about payment of interest on demand deposits as a competitive weapon.

I think that it could be used in a predatory manner, and for a bank with imperialistic designs, this could be a frightfully powerful weapon to attract deposits. So I can't help but feel that should this come about the smaller banks would be the ones that would be hurt the most.

Mr. HANNA. Do you think that we could not safeguard that by any other moves that we could make under existing supervisory powers?

Mr. MITCHELL. Well, no; because if you did get into this sort of a situation, the small bank would have to pay the same return or lose the deposits, and this means that their earning potential would go down and down.

Mr. HANNA. Do you feel any differently about regulation Q, as to time deposits? Do you think we should or should not have a ceiling on interest rates on time deposits?

Mr. MITCHELL. Well, it is easy to give you an answer here, that I might, you know, at some time regret.

It seems to me that philosophically I would like to see all such constraints removed, but I think one has to be extremely careful in timing the removal. My conviction is that if it were removed, it ought to be removed on a standby basis, so that the power to reimpose it is there.

Mr. BOLTON. Would the gentleman yield for a clarification?

Mr. HANNA. Yes.

Mr. BOLTON. As I understand your original question, did it have to do with the demand deposits or with Government deposits?

Mr. HANNA. Demand deposits. I was talking in the latter sense about time deposits.

Mr. BOLTON. Right.

Mr. HANNA. Now, let me ask you about the operation of the discount window of Federal Reserve banks. Do either of you gentlemen feel that an invigorating of the use of the discount window in terms of making a wide arrangement of paper qualified for discount and actually making this a matter of right for the member banks would be bad for the system? Mr. Mitchell?

Mr. MITCHELL. Well, I think in view of the changing portfolio of banks, it would be desirable to make it possible for them to rediscount all kinds of good paper.

As far as the discount window management is concerned, the second part of your question, whether borrowing should be a right or not,

depends on whether you want to use changes in the discount rate to restrict the use of the window.

In recent years since regulation A, which is the regulation controlling borrowing, was revised, borrowing is not regarded as a right, and the discount window is primarily used to make short-term adjustments.

Mr. HANNA. It isn't used very much actually, is it?

Mr. MITCHELL. Well, it is used quite a bit; I think borrowings currently are running around \$200 million. The discount window is an extremely good safety valve, while banks are adjusting their investment position. They can only use the discount window temporarily, especially the larger banks. The smaller banks do use the discount window to some degree for seasonal reasons.

Mr. HANNA. Mr. Daane, would you care to comment?

Mr. DAANE. Well, I would go right along with Governor Mitchell, that I think the archaic definitions of eligible paper should be dropped so that a wider range of paper can be used without penalty.

I served on the discount committee of the Federal Reserve Bank of Richmond, and I think that this would help mechanically in enabling banks, particularly some of the smaller banks, to make better use of the discount window without penalty.

I don't believe that it should be a right. I think the steps taken to modernize the discontinuing mechanism were steps in the right direction. I would not wish to see loss of all control over the use of discounts from an administrative standpoint.

Mr. HANNA. Thank you very much. My time is up. Mr. Chairman, I am delighted to find in this exchange that the gentlemen do not believe that the Federal Reserve is a perfect organization, and that some improvements can be made.

The CHAIRMAN. Mr. Bolton?

Mr. BOLTON. Mr. Chairman, first of all I would like to address a question to my colleague, Mr. Reuss. Did I understand you to say, in asking your question, that you felt that no Government agency can have a direct effect on either the gross national product or on jobs?

Mr. REUSS. That is right. I think the effect is indirect through monetary policy, fiscal policy, or tax policy, but it can't have a turn-on-the-faucet effect as our Federal Reserve System can with the money supply.

If the Federal Reserve System were to have as its members seven Professor Friedmans, they would then control the money supply to a pinpoint or finer. It is easy to do that.

Mr. BOLTON. I was interested in the gentleman's comment, and I doubly appreciate it in view of his position, the rather strong position on that side with respect to not only defense spending but also with respect to ARA and APW, and I appreciate your comment.

Mr. REUSS. I think those things are only indirect in effect. They need to be done. But would that mortal man could control our gross national product and our employment and unemployment by as direct a method as we can control our money supply.

Controlling our money supply is extremely easy to do, and it can be done directly. Whether a given move is wise or not is something that there is much room to argue. But certainly we can control it.

As a start in the analysis of the problem, I think we ought to recognize that.

Mr. BOLTON. I am glad to see that the gentleman's point was merely a relative control, because I was sure I must have misunderstood the fact that he did not feel that there were any Government agencies or programs that had an effect on either the gross national product or on jobs.

Secondly, I would just like to say for the record that I have approached this whole hearing and sets of hearings and these bills on an individual position as a member of the committee, and certainly not on a partisan basis. I was startled by the gentleman's reference to the position of the majority and the minority and would like to ask whether in view of his comment this means that this series of bills are an administration and a majority position.

Mr. REUSS. Certainly the bills that we are considering, which I consider only as a very small part of the scope of this investigation really, these bills are as I understand it, not administration bills. They are bills introduced largely by the chairman and largely so that the witnesses may have something to sink their teeth into.

My comment was simply this: that Democrats generally have been quite critical of the Federal Reserve System's performance in the second half of the fifties, and we made that a great campaign issue and came to power, and then the two Democratic appointees, very fine and sincere and knowledgeable gentlemen, I hasten to add, the two Democratic appointees come up here and outdo the very people that we were criticizing.

Mr. BOLTON. I think it illustrates the——

Mr. REUSS. And let the record show that the members of the minority are again chuckling, as well they might at this.

Mr. VANIK. Mr. Chairman, will the gentleman yield?

Mr. BOLTON. Gladly.

Mr. VANIK. I might say at this point if the interest goes up, I am going to be one of the first to jump all over the Federal Reserve.

Mr. BOLTON. The gentleman has made his position quite clear on that, and I thought he received a very clear answer to his position yesterday.

If I may turn to the witnesses just for a moment, referring to the colloquy with the gentleman from California, Mr. Hanna, I was very interested in your answer regarding the interest rate on demand deposits. Yesterday the position was taken by a witness to the effect that presently there is an evasion of this by the submission of services and other benefits to those who have demand deposits which, were banks permitted to pay interest, would disappear.

And secondly, that by the avoidance through services and other benefits today to those with large demand deposits, that actually there is more leverage and more benefit in competitive structure given to the large banks as contrasted to the smaller banks, and that therefore the smaller banks are worse off under the present regulation of non-payment of interest than they otherwise would be. Would you care to comment on that?

Mr. MITCHELL. Yes, I will be very glad to comment on that. The point of the payment of interest on demand deposits is that if it were permitted, as I understand the proposal, it would operate a good deal like the payment of interest on negotiable certificates of deposit.

Negotiable C.D.'s can be issued now and are being issued now with very small differentials in their offering price, and so they are ex-

tremely competitive. If a bank wants to get additional funds in this fashion, it will change its offering price by as little as perhaps five basis points and get results in terms of inflow. This suggests that with a few basis points change, given the kind of a banking system we have, you could drain deposits, demand deposits, quickly from one bank to another.

Now the payment of interest you referred to in the form of service charges is not susceptible to this type of manipulation on a day-to-day basis. It tends to get woven into the competitive fabric, and I don't think it is a serious problem.

It is also true that a great many banks are now substituting service charges for compensating balances. You might as a large corporation go to a bank and be told: "Well, you can either keep a compensating balance of  $x$  hundred thousand dollars or you can pay so much per transaction."

Some customers prefer to pay by the transaction, and if the bank has a good cost accounting system, of course they are able to do this and do it profitably.

Mr. BOLTON. Would you like to comment on that, Mr. Daane?

Mr. DAANE. No. I think Mr. Mitchell is exactly right. There is some implicit interest payment built in now under the present framework, but nothing like the competitive aspect that would occur if you make an explicit interest payment.

Again going back to the President's Special Committee Report on Financial Institutions, it brings this out and adds the point that the committee doesn't feel that explicit interest payment on our medium of exchange is appropriate, and demand deposits, of course, are our principal medium of exchange.

Mr. HANNA. Will the gentleman yield for a moment at that point?

Mr. BOLTON. I will.

Mr. HANNA. Am I correct in assuming that since you made the change in the regulation Q in the use of these C.D.'s, that there has been an observable flow from demand deposits into time deposits that did not exist before this change?

Mr. MITCHELL. Oh, I think that is true, yes, and even more than that, of course, there have been people who formerly held securities directly who now prefer to hold a deposit and let the bank hold the securities.

Mr. HANNA. In other words, we have made a more vibrant tool out of the time deposits.

Mr. MITCHELL. Very much so.

Mr. HANNA. Yes.

Mr. MITCHELL. Negotiable certificates of deposit have grown from nothing to about \$10 $\frac{1}{2}$  billion now.

The CHAIRMAN. Mr. Vanik?

Mr. VANIK. I have no questions.

The CHAIRMAN. Mr. Brock?

Mr. BROCK. Thank you, Mr. Chairman.

In the nonpartisan spirit we have been observing recently, I want to express my appreciation to Mr. Reuss for his acquiescence in the fact that criticism in the 1960 campaign did create some fiscal problems for this country.

Mr. REUSS. If the gentleman will yield—

Mr. BROCK. Certainly.



Mr. REUSS (continuing). I think there is no doubt that the European central bankers initiated and fueled the very damaging October 1960 run on gold. They did not bring this country to its knees, but they came pretty close to it. However, my point simply was that their threats and fears were, as it turned out, utterly baseless. The Federal Reserve today is just as congenial to them as it was in the late fifties.

Mr. BROCK. I hope they have that same feeling when we get through whipping up the Federal Reserve in these hearings.

Let me get into this problem if I may with either one of you gentlemen of the money supply, brought up perhaps more forcefully by Professor Friedman than any of the witnesses we have had. Under his approach we would eliminate the rediscount, we would eliminate the Federal control over reserve requirements, and use solely the operation of the Open Market Committee to maintain a stable input into the money supply of say 4 percent per year.

Now this would be accomplished through some small department within the Treasury Department, and we would have no Federal Reserve in effect. I would like to ask either of you this question.

Let me say further that he also brought out that the purpose of this was to eliminate one of the variables in our economic structure. In other words, he said the ups and downs are aided by and exaggerated by some of the variables, and one of the variables that he would eliminate is the money stock.

Now, is it possible, in your opinion, if we eliminate rediscount money, if we eliminate your control over reserve requirements and use solely open-market operations, is it possible for these operations to guarantee that we have a fixed input into the money stock of 4 percent on a weekly basis throughout a period of years?

Mr. MITCHELL. In my prepared statement I said something about this, but I think Professor Friedman's prescription is defective.

In the first place the objective of monetary policy is to effect a better climate for the private enterprise economy, so it will grow more rapidly and so it will grow without as much in the way of fluctuations. He has never demonstrated to my satisfaction, and I think to the satisfaction of most of the people in his profession, that the changes in the money supply that he says cause changes in economic activity actually do so.

The point is he doesn't know which comes first, the chicken or the egg, and he has not been able to prove this. Yet he says, "Let's abandon all monetary judgment and just take this simple formula, and then we can forget about discounting, we can forget about changes in reserve requirements and everything will come out fine."

Now as I said in my statement, had we taken this course at the beginning of 1961, we would now have had \$14 billion less credit than we presently have. I happen to be of the school of thought that thinks that we would have a more viable domestic economy if we had a little more credit rather than a little less. Mr. Friedman apparently following his own prescription here, would have interest rates much higher than they are at the present time, and less credit and less economic activity and less employment.

Mr. DAANE. Mr. Brock, could I just add that certainly if you geared up your open market operations to his formula, you could add  $x$  number percentage to the reserve base of the banking system every year.

But as Governor Mitchell has said, this would be far more devastating with respect to the possible impact on the economy. And I'm just wondering, Mr. Reuss, since in your recent book you said, "I have heard no one suggest that we should go back to the chaos that prevailed before 1913," would you say that after yesterday's testimony?

Mr. REUSS. I am not quite sure I understand the question.

Mr. DAANE. In your book you simply said that you had heard no one suggest that we go back to the chaos in our monetary system that prevailed prior to 1913. I wondered whether you would repeat this after Professor Friedman's testimony, where he clearly, by the rigidity in his limits as Governor Mitchell has pointed out, would have had us supply \$14 billion less over these recent years.

Mr. REUSS. Yes. My book, of course, went to the publishers before I heard Mr. Friedman testify. But in defense of Mr. Friedman, who, as you perhaps know, is the financial and monetary adviser to Senator Barry Goldwater, and not me, in defense of Dr. Friedman, he did not really suggest yesterday that we go back to the pre-1913 chaos, a chaos in which there was no regular method of adding to the money supply.

That was the gravamen of the pre-1913 difficulty, and Professor Friedman at least suggests that we should add to it on an annual basis roughly corresponding to the increase in the gross national product which the Employment Act of 1946 requires us to adopt.

Mr. DAANE. But the effects of a rigid addition, rather than having the demands and needs met by the best monetary management, not perfect admittedly, but the best judgment that we can make, is quite a step back toward that pre-1913 rigidity.

Mr. REUSS. I am afraid I am impinging on Mr. Brock's time, but I will be back.

Mr. DAANE. I am sorry.

Mr. BROCK. I happen to agree with the colloquy which has gone on, Mr. Daane, but I would like to clarify one point. You could with open market operations affect the money reserve, but is this the same thing as the money stock or the money supply in existence in the country?

Mr. DAANE. Mr. Reuss was trying to point out I believe earlier in the colloquy with Governor Mitchell that this was a fairly invariant relationship. Actually over the years, of course, it hasn't been. If you want to assume an invariant relationship, you have to assume a banking system that is fully loaned up, or invested up, so that every dollar of reserves does in effect get used. In the kind of expanding, dynamic, growing economy that we have at the present, this is a fair assumption. But there have been periods in the past when this would not hold.

Mr. BROCK. It has been stated that should we have this fixed input and say that people in a psychologically depressed mood as you have during a depression did not have the demand for money—

Mr. DAANE. That is right.

Mr. BROCK. This would of course reduce your money supply no matter what you do with your reserve requirements. The rebuttal is that we can just lower interest rates and so on, until we have reached the point at which they would. Is this a logical philosophy?

Mr. DAANE. Continuing on with you just a moment, certainly you could flood the economy with reserves, not on the Friedman thesis,

because there you would be feeding it in just on a mechanical formula basis, but on the present basis you could flood the economy with reserves and reduce interest rates to a fairly irreducible minimum, as we did in the thirties. But this in and of itself certainly did not produce the expansion in the money supply or the economy that was desired at that time. I think you have a pretty good case illustration.

Mr. BROCK. Professor Brunner, as I recall, said it did have that effect. He said we put a tremendous quantity of money in. I am not arguing with you, but I am simply trying to bring out some of these inconsistencies. He said we did have a tremendous input up until 1936, at which time the Fed adopted a highly restrictive policy and doubled reserve requirements, and therefore we caused a recession in—

Mr. DAANE. There are a lot of other things than the money stock that enter into the factors accounting for aggregate economic activity. At times the role of money stock is simply a permissive one. As Governor Mitchell has pointed out, there is no proof of a line of causation.

My own view is quite skeptical of this line of causation, so that I would dissent from this conclusion that Professor Brunner has reached, and I think Governor Mitchell has demonstrated in his charts some of the fallacy in it.

Mr. MITCHELL. Could I make a comment here?

Mr. BROCK. Certainly.

Mr. MITCHELL. Because I think that it hasn't been brought out yet. When the Federal Reserve conducts open market operations, it provides the person from whom it is buying securities with a deposit in a bank. Now these deposits add to that bank's reserves.

Now the question is what will a bank do with unused reserves. The small country banks typically carry unused reserves because it is uneconomical for them to put them to work. But a large bank, typically a reserve city bank, has a man who runs what is called the money position. His job is to keep excess reserves in the bank at a minimum. In other words, his job is to put every dollar's worth of reserves to work to the fullest extent of his ability.

Now this is the point. To the extent he and his counterparts succeed in doing this, you will have additions to the money supply proportionate to the Federal Reserve's open market operations.

Mr. BROCK. In that one sense.

Mr. MITCHELL. Yes, in this case. Now the point is that this means you get more money, but it may mean that the turnover of money tends to decline if you are in a slack period. And so when you put turnover and money supply together, which Professor Friedman does not do, you get an entirely different effect than he implies in just his money stock analysis.

Mr. BROCK. My time has expired, but I appreciate that. Thank you.

The CHAIRMAN. It is my plan to summarize what you gentlemen have said, without asking you questions, in the interest of time. Mr. Reuss had some other questions when his time expired a while ago, and I want to yield to him after I summarize. If you gentlemen desire to comment on what I have said in the record when you examine your transcript of testimony, you may do so.

No. 1, I would like to comment on the Presidents of these 12 Federal Reserve banks not taking an oath of office. They do not take an oath

of office. They should take an oath of office, but they never take any kind of an oath until they become official members of the Open Market Committee.

They don't take an oath as Presidents of the Federal Reserve bank that they represent. They take an oath as members of the Open Market Committee. But this is an entirely separate and distinct thing. I think this omission should be corrected.

Also, although the Directors do take an oath, the oath is very limited. It is not a constitutional oath. They just take an oath that they will not discriminate against banks as though it were strictly a banking deal that they were looking after as directors of the Federal Reserve banks, having no reference to the public interest at all. I think that this omission should be corrected too because the public interest doesn't seem to be represented.

Now, about Mr. Martin's statement and possible testimony that the Chairman of the Board's term should be coterminous with the President. It is my understanding that he did not say that the President would be allowed real freedom of choice. If he had said so, he would have recommended that the statute be changed in some way, because if you are going to give the President an opportunity to have real freedom of choice, and the Board is fully filled, if the President goes out and gets someone to be Chairman, that will either make eight members of the Board or one of the Board members will be required to resign. If Mr. Martin really wants the President to have freedom of choice and make the Chairman's term coterminous with the President's term, he'll have to resign as Chairman and as Governor too—or else persuade one of the other Governors to resign.

Another thing that attracted my attention in the testimony was Mr. Mitchell saying the Fed looks upon this 6-percent dividend which is paid to the member banks on their so-called stock as an inducement for banks to join and stay in the System. I do not see how this can mean too much, because last year the banks made nearly 10 percent after taxes on their capital. What inducement is there for them to hold a capital investment paying 6 percent when they are making nearly 10 percent on capital right now, and made over 9 percent during the last 10 years, as brought out by you gentlemen in your testimony.

I also find the statement that Mr. Daane made about the briefing you receive before Open Market Committee meetings a little curious. The briefing includes a 30- to 40-page written document and about 2 hours of oral briefings, both of which concern such subjects as production and employment, incomes, trade, wages, cost, prices, construction, agriculture, credit, capital, money, savings, taxes, and the balance of payments. But evidently the briefing does not cover the rate of interest. I consider this item to be very important.

Interest is one of the most important costs paid by consumers and taxpayers. I think it should be in every briefing that is held, and I am surprised that the Federal Reserve does not recognize the importance of interest rates. I'd like your comments on this.

The hearings also have brought out some points about the operating procedure of our monetary authority, which I don't think anybody can possibly tolerate as a national policy. One point is that there are really 19 members of the Open Market Committee, although the legal limit is 12. It is my belief that the Open Market Committee is operating in violation of the law and has for sometime.

Mr. Martin himself said that there are 19 participants at Open Market Committee sessions. But Congress passed a law saying there would be only 12. The Open Market Committee meets in secret session. The Committee allows seven men to come in, although they are not members. They are presidents of district Reserve banks but not Committee members. They haven't taken any oath because the oath doesn't apply to them unless they are Committee members. Now there are also 30 or 40 other people acting in advisory capacities in that room when the Open Market Committee meets. What all these people say and do determines the volume of money and interest costs.

Now, for all we know, the nonmembers may have as much to say in determining the money supply and interest as the 12 lawful participants. They don't tell Congress anything about what happens. They refuse to tell Congress anything that happens. They don't tell anybody. The President has nobody there. He doesn't have any representative. So even the President cannot know what goes on unless someone is kind enough to tell him.

But commercial banks are represented, and the banks are the ones who can profit the most by open market operations. I don't believe that this kind of operating procedure can be tolerated in a democracy, in a republic. If you gentlemen would like to comment on that when you see this transcript, it will be all right.

Still another matter of real concern is that for 50 years you have had no audit, no Government audit, no independent audit, just an audit of your own, a self audit. When you handle hundreds of billions of dollars a year of Government money, of Government credit, nobody looks over your shoulder except some of your own people. I don't think that should be tolerated in a democracy and a republic. I would like to have the comments of you gentlemen on that particular point, too.

Another thing that I am concerned about is that during the last several years, if instead of lowering reserve requirements to let the banks have high power dollars upon which the banking system could issue \$10 in making investments or loans for every one high-powered dollar, if instead of lowering the reserve requirements you had gone into the market and bought Government bonds, the Government bonds that the Fed would hold today would be at least \$10 or \$15 billion more than the \$33 billion it now holds. This would be a tremendous help to the taxpayers because the interest on those bonds would have come back, all of it, directly into the Treasury, and today that would mean a saving to the taxpayer of \$350 to \$550 billion a year. You might comment on that, too.

Finally I'd like your comments on one other matter. You both have indicated, and everyone else at the Fed seems to agree with you, that we don't know very much about the link between the volume of money and the economy. Now what I don't understand is why the Fed spends money on research into things like the wheat problem and manpower retraining, which are the legitimate concern of the Departments of Agriculture and Labor, when there's so much to be learned about the role money plays in our economy. Why haven't you studied what changes in the volume of money and interest rates do to employment, profits, prices, investment, and our economy's growth? Why do we have to depend on economists outside the Fed to advance our knowledge of the link between money and economic activity? And why do

you spend so much effort trying to tear down their work when it would be far more beneficial if you did some constructive research with part of all that money you get without having to come to Congress for it and can spend without the GAO checking on how you spend it? At this time I yield to Mr. Reuss.

(The additional information requested by the chairman follows:)

SUPPLEMENTAL STATEMENT OF GOVERNOR MITCHELL AND GOVERNOR DAANE

In response to Chairman Patman's request, we submit the following comments on questions he raised that were not previously covered in our testimony.

Chairman Martin's support for legislation authorizing a new President to appoint a Chairman of the Board of Governors of his own choice is a matter of public record. President Kennedy submitted such a proposal to the Congress on April 17, 1962. It provided that the terms of the Chairman and Vice Chairman should expire on January 31 of the year in which the President's term expires, and that all Board members' terms should expire in odd-numbered years, rather than even-numbered years as is now the case. The President's message transmitting this proposal stated explicitly the reason for this change: "In order that the President may be able to appoint a Chairman of his own choice shortly after his inauguration, he must have an opening on the Board of Governors to fill at the same time." The bill was introduced by Senator Robertson as S. 3202 of the last Congress. In response to Senator Robertson's request for his views, Chairman Martin wrote the Senator a letter supporting the bill. The full text of the letter may be found at page 7160 of the Congressional Record for April 25, 1962.

At another point in his statement, Chairman Patman observed that he did not see how a 6-percent dividend on capital stock in a Federal Reserve bank could be much of an inducement to membership in the System when member banks, in recent years, have been making net profits of 9 to 10 percent. This comparison is inappropriate; the 9 percent is a net return on capital and the 6 percent is a gross return on an asset. A commercial bank operates with assets of 10 or more times its capital. Therefore, a return of 6 percent on an asset normally converts into a substantially larger return on its capital, even after deducting for expenses. A more appropriate comparison, therefore, would be with the average return on bank assets, which is well below 6 percent. On this basis, Federal Reserve bank stock is an attractive investment.

The description of Open Market Committee briefings was not intended to be all-inclusive, but it did include "costs" and "prices" (which includes the cost of living index) and the Federal Reserve does, of course, follow interest rate developments closely.

As to the question of secrecy on the part of the Federal Open Market Committee concerning its operations, it should be borne in mind that the results of the policy decisions made by the Committee are reported promptly and regularly to the public. The immediate results of the Committee's deliberations are decisions to buy or sell securities; each week, on Thursday, the System makes public a statement of the securities it held as of the preceding day, showing changes in its holdings during the past week and during the past year. This statement also shows total member bank reserves, excess reserves, and free reserves and describes the factors affecting bank reserves during the week. Current figures on the money supply and interest rates are published in a variety of forms by the System, as well as other sources. So whether monetary policy is evaluated by its impact on the money supply, or its impact on bank reserves, or its impact on the money market, or a combination of these factors, the relevant facts are made available for all. The annual report by the Board to the Congress contains a detailed record of policy decisions by the Open Market Committee, including (1) a record, by name, of all votes cast by each member of the Committee in connection with the determination of open market policies; (2) summaries of the economic and financial developments and conditions taken into account in arriving at policy actions; (3) statements of the reasons underlying the actions of the Committee; and (4) statements of the reasons underlying dissents, when there are dissents. A copy of this policy record for 1963 was furnished your committee early this year, in advance of the filing of the full annual report.

Mr. REUSS. I want to pursue with you gentlemen the theme that we were discussing, which had to do not with whether we should substitute a mechanical formula like Dr. Friedman's for existing monetary policy, but whether the money supply was an important factor in economic growth. I think it is.

Mr. Mitchell says, quoting from page 13:

It has not even been established in times like these whether changes in money supply precede change in economic activity or vice versa.

I gather Mr. Daane agrees with that, and I emphatically disagree. I think that this philosophy is what is wrong with Federal Reserve policy today, so this is an important question to explore.

Let me ask Mr. Mitchell this. In the year from February 1957 to February 1958 the Federal Reserve actually decreased the narrowly defined money supply. It decreased it from \$137 to \$136 billion. In the middle of this 1-year period, in July 1957, there was the start of a serious recession and enhanced unemployment.

Again in the year following July 1959 the Fed again decreased the money supply from \$143 to \$139 billion by June 1960, and again at the midpoint of this adventure, in February 1960, a serious recession started with much unemployment and suffering.

My question is this: In saying as I do that the Federal Reserve's decrease in the money supply had something, and an unfortunate something, to do with the unemployment and recession that followed, am I guilty of McCarthyism, of guilt by association, or is there not a causal connection between this strangulation of the money supply and the unemployment and recession which followed?

Mr. MITCHELL. I think you put it beautifully. This is guilt by association; yes.

Mr. REUSS. I am guilty of monetary McCarthyism?

Mr. MITCHELL. Yes; that is right, because we don't know which comes first. If you have a decline in business activity, it will of itself result in a decline in velocity and/or a decline in the money supply. Free reserves rise.

Mr. REUSS. Let's get that again. A falloff in business activity necessarily involves a decline in the money supply?

Mr. MITCHELL. In money use. You have to look at turnover as well as money supply.

Mr. REUSS. Let's go a little slower now. You have just testified that nowadays the boys with the sharp pencil in the big city banks who control most of the credit of this country, when they can't make loans make investments, and that is my experience as to how they operate.

Mr. MITCHELL. That is true, but—

Mr. REUSS. Well, then why, when the loan window atrophies through a moderation of business activity, aren't these same money boys at the banks going to increase their portfolio of investments?

Mr. MITCHELL. Yes, but you have a big range of these sharp-pencil boys. Some of their pencils are not very sharp and some don't even have a pencil, so that in between here you have people who are not responding because of the change in interest rates and the fact that it is not as profitable to be a sharp-pencil fellow at one time as it is at another. In other words, the rate of interest has something to do with the strength of the effort to minimize excess reserves.

Mr. REUSS. I would like both of you gentlemen to file for the record a study, which I am sure has been made by the Fed, of the last 10 years, let's restrict it to that, of the banking system's use of its Reserve power to create earning assets, either by loans or by investments.

Mr. BROCK. Will the gentleman yield?

Mr. REUSS. Yes, but I cannot yield at this moment. I will be very surprised to find that city banks were letting possible earning assets die aborning because they never used their reserve power, but this is an important question, and obviously it would not be fair for me to ask you to answer it offhand, but I would appreciate at this point in the record in your filing your findings on that.

Mr. DAANE. Could I just interrupt with one comment, Mr. Reuss.

Mr. REUSS. Surely.

Mr. DAANE. You did have a substantial increase in excess reserves in the hands of those banks that don't have the sharp pencils or the opportunity to exercise them.

Mr. REUSS. Yes. Well, I would like to see those, because this all bears on the question of this relationship.

Mr. BROCK. Can I ask him to include one other thing.

Mr. REUSS. Surely.

Mr. BROCK. Would you also include the difference between the addition to the money supply, when you have additional reserves from loans and when it is put into investments, they have two different effects upon the money supply. Would you give us your opinion as to the relationship between the addition to the money supply through loans and through investments, when they do shift from one to the other, when they can't make loans, in other words there is no demand, and they shift into investment.

Mr. REUSS. To continue, having established that I think that the Federal Reserve money supply policy of 1957 and 1960 respectively, had something to do with the ensuing recessions and increases in unemployment, and you gentlemen having established that you don't think it had anything to do with that, let me go on to another point.

Mr. Mitchell, you take Professor Friedman to task because you say that if we have followed Professor Friedman and his 4-percent money supply expansion formula, we would have increased money supply less since 1961 than we, in fact, have increased it. That is the point you make.

Mr. MITCHELL. That is right.

Mr. REUSS. Again in fairness to Dr. Friedman, I think it should be stated that he professed concern, a concern which I don't feel, he professed concern at the fact that we have exceeded his formula in the last few years, and thinks that we have created money at too rapid a rate.

However, would it not be fairer to look at say the whole 10-year period from 1953 to the present date, and if you do that, defining the money supply precisely as Mr. Friedman does to include time as well as demand deposits, the increase per year of the money supply has been at a 3-percent rate or less, so that wouldn't you agree with Professor Friedman's criticism that in the last 10 years the Federal Reserve has allowed, on the average, for increases in the money supply



which are inadequate for the kind of maximum employment and production which the Employment Act of 1946 enjoins upon us? Would you agree or disagree with that?

Mr. MITCHELL. I wouldn't want to make a statement without reviewing the specific period that you are referring to. A lot depends upon where you begin to examine or make a comparison.

I was just referring to this one economic upturn, which began about that time, and saying that he would provide less to finance this upturn than I think is desirable.

Mr. REUSS. So that—

Mr. MITCHELL. Or that the Federal Reserve has thought was desirable as a group.

Mr. REUSS. You, however, did pick the period, 1961 to date, the most rapid period of Federal Reserve money creation in recent years, and then proceeded to—

Mr. MITCHELL. I did this for a very specific additional reason. One is that he uses a definition of the money supply, which includes time deposits. If you ask him why he includes time deposits, he says, "I only include them because they work better."

Now when the Federal Reserve changed regulation Q, time deposits of commercial banks became more competitive with direct holding of Government securities than they ever had before, and they became much more competitive with savings and loan associations, and as a result time deposits went up very sharply. This illustrates the trouble with using a fixed inflexible rule, because a change in environment took place that he never anticipated, and his rule just won't work under these conditions.

Mr. REUSS. This is one of the reasons why I am not dominated by Professor Friedman. But let me see if we can't find one area of agreement here. In that same paragraph on page 13, when you were talking about Professor Friedman, you talk about the Federal Reserve formulating monetary policy with "a more logically defined money supply."

Mr. MITCHELL. Narrowly defined.

Mr. REUSS. Good for you. You think that currency outside banks and demand deposits is a more sensible view of the money supply.

Mr. MITCHELL. That is right.

Mr. REUSS. So do I. Using that more sensible and logical view of the money supply, is it not a fact that the Federal Reserve System in the last 10 years since 1953 has produced expansions of the money supply which have been inadequate to the maintenance of the maximum employment and production goals of the Employment Act of 1946?

Mr. MITCHELL. The way you put this question makes it extremely difficult to answer, because it is just like Professor Friedman's monetary history. It is a money supply interpretation of history, and this is the kind of box you are placing me in, in asking this question in this form. I happen to think that there were times when we should have been pushing the money supply harder.

Mr. REUSS. Will you agree that our decreasing of the money supply in the 1957 and 1960 periods that I have referred to, followed in each case by severe recession and unemployment, was not the Federal Reserve's finest hour?

Mr. MITCHELL. Well, the period of the 1957 experience—my vote is not recorded any place, so this is just free information—my feeling was that the Federal Reserve did not switch policy early enough in 1957, and I think the facts warranted an earlier switch, and if I had been a member of the Board, I would have voted for an earlier switch than the one which occurred.

But I don't think that you can expect the Federal Reserve's performance to be perfect. If you look at the policy record, I think you will find—and I thought you were going to give me a chance to read from the policy record—where the Federal Open Market Committee expressed a concern about what was happening to the money supply.

Mr. REUSS. Instead of just expressing concern, why didn't they do something about it until after—

Mr. MITCHELL (interrupting). They were attempting to do something.

Mr. REUSS (continuing). Until after unemployment went up?

Mr. MITCHELL. Well, the point is that the money supply, if you just focus your attention on the money supply to the exclusion of what happens to interest rates and credit conditions—

Mr. REUSS. Which I do not suggest doing.

Mr. MITCHELL. But you don't suggest doing. But you see the Federal Reserve is looking at all of these other factors, too, and not just to the money supply. That is the reason it can't make the money supply respond at the moment it wants to, and in the way that Professor Friedman recommends.

This is the point at which we started. I said yes, we could make the money supply follow the Friedman prescription if we forget about all other considerations, but not unless.

Mr. REUSS. Mr. Daane, on page 4 of your report you purport to recite the objectives of the Employment Act of 1946, and you there refer to "sustained high levels of production and employment." This is the way the Fed constantly reads the Employment Act of 1946, but I can assure you that isn't what Congress said.

Mr. DAANE. No, Mr. Reuss—

Mr. REUSS. If I may finish; what the Congress said was "maximum employment and production," and this "sustained" talk has been used constantly by the Fed to choke off an expansion on the ground of "we had better put on the brakes here because if this economy gets going too good, we won't be able to sustain it," and this I think has been very harmful in 1957 and 1960 and at other times.

Therefore won't you take a look at the actual wording of this act, and put in "maximum employment and production" instead of this "sustained" stuff.

Mr. DAANE. When you get the stenographic record, Mr. Reuss, you will see that at that point I reiterated that we are concerned with "maximum employment, production and purchasing power," if you would like the reporting gentleman to go back to it, you will find that I added the specific words from the Employment Act.

Mr. REUSS. Yes, except if you and your colleagues keep putting in this "sustained" stuff, you get into a frame of mind where you think you are doing your duty when you put on the brakes the minute things get going reasonably well on the ground that if you don't, it can't be sustained.

Mr. BOLTON. Will the gentleman yield?

Mr. REUSS. I hope that in future presentations, and not only in the stenographic record but in your mimeographed format, you will observe the Biblical admonition that in the beginning was the word, and the word is really "maximum employment and production," not "sustained high levels of employment."

Mr. DAANE. I would be glad to assure you, Mr. Reuss, I have that in my mind.

Mr. REUSS. I will be glad to yield to Mr. Bolton.

Mr. BOLTON. Doesn't the gentleman agree that the word "sustained" does have some real bearing in view of the comment, the added language that the chairman called our attention to was also in the act, which is maximum purchasing power.

Mr. REUSS. On that I have no quarrel with Mr. Daane's formulation. I did not read it, but he has in there "reasonable price stability," which is, I think, a completely fair rendering of maximum purchasing power, and I do not criticize the Fed for those aspects of its activities which are devoted to reasonable price stability. They operate there about as I would operate.

What I do criticize them for is their slamming on the brakes and keeping us thereby from reaching maximum employment and production. We haven't reached that for the last 10 years.

Mr. BOLTON. That is the very point I am trying to pick up the gentleman on, because in judging the balance, they have, in addition to making every effort to create an ever-expanding economy—to create maximum employment—they also must take into consideration the question of whether or not inflation with the reduction in purchasing power is going to accompany it.

The fact that their judgment and yours or mine or anybody else's may differ as of a given moment—and this is the question that Professor Friedman, I think, made best of all the points he made yesterday—to the effect that the major reason that he was for the static injection of a greater money supply was because this took out of the human judgment field, which had according to the way he figured it proven to be fallible over the past history of the monetary transactions.

But I don't see how you could criticize the gentleman for making a judgment when that judgment must take into effect not only maximum employment, but must also take in the question of purchasing power, and therefore of inflation and the value of the dollar.

Mr. REUSS. Let me state why I was critical. The goals of the Employment Act of 1946 are threefold: maximum employment, maximum production, and maximum purchasing power. I want all those goals pursued, including the third one.

Mr. BOLTON. Of course.

Mr. REUSS. But I don't want the first two diluted by putting in little words like "sustained," which in the past have been used, quite apart from maximum purchasing power, to justify, incredible though it may seem, activity by the money managers to moderate upward economic activity before maximum employment and production, accompanied by maximum price stability, is attained. This I think is wrong.

Well, just let me say that if Mr. Daane or Mr. Mitchell on reading this record find a comma or a syllable in what I have just said on this subject with which they disagree, let them spread their disagreement on the record on that point.

Mr. DAANE. It is a matter of semantics, I am sure, Mr. Reuss. We are interested, you and I, in exactly the same thing; namely, the objectives of the employment act. But I do happen to believe that a sustainable expansion—sustained over longer periods, and we have had one right now—will overtime produce maximum production, employment, and purchasing power. I think this is semantic matter. We don't disagree.

Mr. REUSS. I must resist this embrace, because when you put in "sustainable" you are getting away from maximum, and this isn't just quibbling. I yield to the chairman.

The CHAIRMAN. May I suggest to you gentlemen that Mr. Martin—I brought that to his attention, and he changed it and added maximum purchasing power. But I think over the years the Fed has insisted on leaving maximum purchasing power out.

I was the author of the employment act, we called it the Full Employment Act when it was started. The only change we made in it was to make it maximum instead of full. I was the first witness before the committee that considered and recommended the bill. I believe that I know something about what the purposes were.

I think you will find in there the three maximums that have been discussed here, but nothing is said about the Federal Reserve at all. The Federal Reserve is just embraced in the Employment Act of 1946; it is given no special assignment. Moreover, the act does say, I know, because it was discussed a long time in the committee, it does say that all the agencies of the Government, and this includes the Fed, will in coordination carry out these policies.

Nowhere does it say that the Federal Reserve will do this by itself. The Federal Reserve is not even mentioned in the act. But the Federal Reserve's policies and instructions and guidance from Congress have been very limited, and I think the Federal Reserve looks upon this vacuum as a great opportunity and so it took on the goals of the Full Employment Act as additional responsibilities. I will admit the Fed should try to achieve these goals but not by yourself but in coordination with other agencies. Do you agree with me on that coordination?

Mr. MITCHELL. Certainly.

Mr. DAANE. We have certainly had coordination with other agencies.

The CHAIRMAN. I haven't heard about any coordinating efforts and meetings.

Mr. DAANE. We certainly have coordination, Mr. Chairman, with other agencies, as I tried to point out in my statement, toward the same objectives as the rest of government.

The CHAIRMAN. Yes, but the Fed in discussing its functions invariably leaves out it is supposed to achieve the goals of the Full Employment Act in coordination with other agencies. So I think that some consideration should be given to that in the future.

Mr. REUSS. Thank you, Mr. Chairman.

The CHAIRMAN. Will it be all right to submit questions of any members, including members of the full committee, to you gentlemen, and you may answer them when you look over the transcript?

Mr. DAANE. Certainly, Mr. Chairman. May I just add one word on Mr. Widnall's question as to the Bank of England changing the

bank rate, because I think it is an important question that has implications in terms of markets both here and abroad.

The only addition I would like to make for the record is simply that there was an unprecedented degree of consultation between the United Kingdom authorities and our authorities before this move was taken, which I believe augers for no disturbing competitive flows of funds as a result of this change in the bank rate. And in fact we still have in our markets on the basis of a comparison of our bill rate and the United Kingdom rate, on a covered basis, a slight advantage our way.

So I guess all I am trying to be sure to get in the record is that this move, just like our move last July, was not intended to attract funds competitively, but rather to deter an outflow, an interest induced outflow.

The CHAIRMAN. Yes, sir. Thank you very much, gentlemen.

Mr. MITCHELL. Thank you, sir.

Mr. DAANE. Thank you, sir.

The CHAIRMAN. Thank you. If you desire to make comments as you go along in the transcript, you may be privileged to do so.

(Replies of Milton Friedman and Karl Brunner on testimony of Governors Mitchell and Daane are as follows:)

COMMENTS BY MILTON FRIEDMAN ON TESTIMONY OF GEORGE W. MITCHELL AND J. DEWEY DAANE

I am grateful to Chairman Patman for giving me an opportunity to comment for the record on remarks by the witnesses that refer to my work and to my testimony before this committee. For ease in cross-reference, I shall comment on the various points raised in the order in which they occur in the testimony, and for brevity, I shall restrict myself to the more controversial and immediately relevant comments.

1. Mr. Mitchell: "Had we at the beginning of 1961 adopted the Friedman proposal for a constant 4 percent rate of expansion in money supply \* \* \* we would have added some \$14 billion less to credit supplies than actually was provided by the monetary policies followed by the Federal Reserve in these years."

This is arithmetically true but extremely misleading. In the first place, as Mr. Reuss brought out later in the testimony, the results depend very much on the starting point. I would never want to argue that a constant rate of growth would be better for every conceivable pair of dates but only that on the average over considerable periods, it will provide a stabler and preferable monetary policy. In this particular case, Mr. Mitchell has chosen as his starting point a date preceded by an unduly slow rate of growth in the money supply. Given the prior mistake, it was desirable to have a somewhat more rapid rate of rise over this period than the rule would have given, if we start it at the point Mr. Mitchell chooses.

In the second place, Mr. Mitchell neglects to point out that during these years the money supply to which I would apply the 4 percent rule (currency outside banks plus demand and time deposits of commercial banks) not only grew much faster than the narrower money supply of currency plus demand deposits but that the difference in rates of growth is much larger than it has been at any earlier time. The reason it is larger is because of Federal Reserve action in changing discontinuously the rate of interest banks may pay on time deposits. As a consequence, part of the growth in the broader money supply was at the expense of other assets. Under my proposals of both a steady rate of growth and no legal ceiling on interest rates paid by banks, the two money supply totals would have grown at more nearly the same rate, and a smaller rate of growth in a broader money supply would have been as expansionary as the actual rate of growth. Hence, even for this particular period since 1961, I believe that the rule, correctly applied, would have been superior to actual policy.

In the third place, even neglecting these qualifications, as I pointed out in my testimony, the money supply has for the past 15 months or so, been growing at a faster rate than can be maintained indefinitely. Hence, it would have been desirable to have had a somewhat smaller growth. As I pointed out in my testimony, while the Reserve System moved in the right direction in late 1962, it moved too far in that direction.

2. Mr. Mitchell: "The nature of the causal process [whereby changes in the money supply causes fluctuations in economic activity] is important \* \* \* it has not been delineated, and \* \* \* I have seen nothing to demonstrate that the causal relationship is constant in degree or timing over economic cycles or over long periods when basic structural relationships in the economy have changed."

Except for the final statement (about long periods), I am in entire agreement. We need more knowledge about the nature of the causal process, we need a fuller delineation of it. I have no doubt that the causal relation is not constant in degree or timing over economic cycles. Indeed, I have argued elsewhere that there is much evidence it is variable. Where I disagree is with the conclusion Mr. Mitchell draws from these observations. He concludes that therefore there is no argument "for abandoning discretionary money management in favor of a rigid formula."

Surely, this conclusion is a non sequitur. If Mr. Mitchell does not know the nature of the causal process; if it is not constant in degree or timing, how can he know what monetary action to take at his discretion? How does he get knowledge out of ignorance? I would have supposed that much more precise and accurate knowledge would be required to know what delicate jugglings of the monetary supply would have the desired effect in each instance than to know that a constant rate of growth of the money supply would not be an independent source of disturbance. Perhaps this is wrong, but is not some evidence required before the opposite conclusion can be accepted? What evidence do Mr. Mitchell and his colleagues offer? Some of us have tried to examine the evidence for the past and have concluded that the Reserve System has not had the knowledge required. If the Reserve System rejects our conclusion, ought it not provide some counterevidence and not simply content itself with irrelevant homilies about "thought, judgment, discretion, and concern for the world as it is"?

As to the long-period stability of the average relation between money and business, I should like to refer Mr. Mitchell to two publications he has apparently not seen, which provide a good deal of evidence, both by Anna J. Schwartz and myself: "Money and Business Cycles," published in a Supplement to the Review of Economics and Statistics, XLV, No. 1 (Feb. 1963), part 2, 32-64; "A Monetary History of the United States, 1867-1960" (Princeton University Press for National Bureau of Economic Research, 1963).

3. Mr. Daane: "Mr. Reuss, in your recent book you said 'I have heard no one suggest that we should go back to the chaos that prevailed before 1913,' I wonder whether you would repeat this after Professor Friedman's testimony?"

As Mr. Reuss subsequently pointed out, I am not in favor of going back to the situation as it existed before 1913; I am in favor of substituting a steady rate of growth of the money supply for the unsteady, erratic growth we then had.

However, it is worth pointing out that the alleged "chaos" that preceded the enactment of the Federal Reserve Act seems to have produced a higher degree of monetary and economic stability than the period since. If one compares the 50 years before the Federal Reserve System with the 50 years since, the quantity of money apparently fluctuated less in the earlier period than in the later, and so did economic activity in general. I say "apparently" because the statistical evidence is much less adequate for the earlier than for the later period. However, the evidence is certainly sufficient to justify the milder conclusion that the later period was not distinctly stabler than the earlier.

One immediate objection to this comparison is that the later period contained two major wars. However, the result is the same even if all war years are omitted from the later comparison: The money supply and economic activity were apparently less stable in the later peacetime years, when money was supposedly being managed by men who were applying "thought, judgment, discretion, and concern for the world as it is," to quote Mr. Mitchell, than in the earlier years of "chaos," to quote Mr. Daane, when the money supply was largely at the mercy of the unfettered gold standard.

Perhaps there is some satisfactory explanation why money managers were not able to improve on chaos. Perhaps they faced harder problems of adjust-

ment. Or, perhaps even if they were not able to improve on chaos in the past, they now know enough to do so in the future. Surely, it is about time that the System provided some evidence on these points—or at the very least, criticized the evidence others of us have tried to provide. It is disappointing to see them instead retreat behind what they present as platitudes about rigidity versus judgment and discretion but what are in fact illogical evasions of the substantive issues. I can understand how this position could be expressed in the 10th Annual Report of the System, where incidentally it was stated with rather more subtlety and sophistication than it is currently being stated. But it is now some four decades of rather informative experience later, and by now I believe the Congress and the people of the United States deserve a less superficial justification for assigning large and potentially dangerous powers to the unfettered discretion of a few men.

4. Mr. Mitchell: "The point is that this means you get more money, but it means that the turnover of money tends to decline if you are in a slack period. And so when you put turnover and money supply together, which Professor Friedman never does, you get an entirely different effect than he implies in just his money stock analysis."

Apparently, Mr. Mitchell has neither read my work nor examined the empirical evidence which is presented in it. If he had done so, he would have found that I have examined intensively the behavior of the velocity of circulation of money (what he calls turnover), that I have studied its secular and cyclical behavior, and have tried to present some theoretical explanation of why velocity behaves as it does. He would find also that the facts are the very opposite of what he asserts them to be. On the average, velocity tends to move in the same direction as the quantity of money and not in the opposite direction, though a full statement of the relation would require some minor qualification. For the period of the Reserve System, perhaps money supply and velocity have moved in the same direction because the System has reinforced the forces making for instability rather than offset them. Once again, perhaps the future can and will be different, but Mr. Mitchell says nothing in his testimony to suggest that it will be.

In my opinion, taking into account the actual relation between money supply and turnover strengthens, rather than weakens, the case for a fixed rule of a constant rate of growth instead of discretionary monetary management of the kind we have experienced.

5. Mr. Mitchell: "He [Friedman] happened to fumble into a definition of the money supply, which includes time deposits \* \* \*. Now when the Federal Reserve changed the regulation Q, time deposits of commercial banks became more competitive with direct holdings of Government securities \* \* \* and \* \* \* with savings and loan associations, and as a result time deposits went up very sharply. This illustrates the trouble using a fixed inflexible rule, because the change in environment took place that he never anticipated, and means that his rule just won't work under these conditions."

As to definition, I regard the choice as a matter of convenience, not principle, as I have repeatedly written. Neither definition can be regarded as more logical than the other. I have examined a very wide range of evidence and the bulk of it favors the broader total. However, perhaps that is the wrong choice, and I am certainly anxious to see any evidence Mr. Mitchell may have which indicates that it is the wrong choice. I am not so far aware of any which has been published by the Reserve System.

In any event, in my testimony before your committee, I presented data for both totals. Whenever feasible, I have used both in the statistical analyses I have made. I know of no significant empirical finding or policy conclusion that would have been changed by the use of one definition rather than the other, provided numerical magnitudes relevant to one definition are not treated as applying to the other. For example, the rule of a steady growth could be applied to either. However, the desirable numerical rate of growth must be adapted to the definition used. Historical evidence suggests that a rate of growth between 3 and 5 percent for the broader total (currency outside banks plus all privately held deposits of commercial banks) would be consistent with roughly stable prices; while for the narrower total (currency plus demand deposits only), the corresponding range is about 2 to 4 percent.

More important is the rather extraordinary statement by Mr. Mitchell about the alleged trouble in using a fixed inflexible rule. The trouble, he says, is that the rule cannot deal with erratic changes in the environment caused by Federal Reserve discretionary action. The automatic pilot won't work when the live pilot jiggles it. Hence, he says, dispense with the automatic pilot.<sup>1</sup>

<sup>1</sup> A response by Governor Mitchell to the foregoing comments appears in the appendix of the report.

## COMMENTS ON GOVERNOR MITCHELL'S TESTIMONY

(By Karl Brunner)

I appreciate the opportunity offered me by Chairman Patman to comment in some detail on Governor Mitchell's testimony presented before this committee.

Governor Mitchell criticizes my testimony given to this committee on February 26 in the context of a reference to some remarks made in my lecture to the Research Division of the Board of Governors on February 27, 1964.<sup>1</sup> He particularly notes the importance I attached to the existence of a highly competitive market for ideas. The operation of such a market provides the critical examination of ideas so necessary for the growth in our systematic knowledge. I also emphasized however the importance of the rules guiding the competitive process. The critical examination applied to our ideas should be based on relevant logical considerations; i.e., considerations related to the logical status of the propositions made. Such rules are not a sufficient condition to maximize the accrual of reliable knowledge, but they definitely provide a necessary condition. The statement prepared by Governor Mitchell is thus a welcome contribution to our mutual appraisal. However, its appearance in the public domain also exposes it to a searching inquiry bearing on the state of knowledge and analytic procedures of the Federal Reserve authorities. Such inquiry is the purpose of my comments, which concentrate on the last section of Governor Mitchell's opening statement.

The objections raised by Governor Mitchell may be usefully divided into three groups, one dealing with some observational references made in my testimony, another with the policy recommendation attributed to me, and the last with his arguments bearing on the choice between discretionary management and a rule guiding policy actions.

1. According to the statement read by Governor Mitchell my contention concerning the general nature of the causal process linking money and economic activity was based on a juxtaposition of the growth rate in the money supply with turning points in economic activity. It is argued that such "bare statistical exercises" cannot "demonstrate" or "prove" the lines of causation. This argument fails on several points.

(i) Chart I of my statement, which exhibits the annual percentage changes in the money supply between corresponding months, was primarily used to discuss the Federal Reserve's misconceived assessment of its policy action. It occurred in the context of a discussion attending to the nature of the money supply process and the Federal Reserve's conception of this process. This problem is not even mentioned in Governor Mitchell's statement, which deals only with the issue posed by the choice between "rules and authority."

It is noteworthy that Governor Mitchell bypasses the fundamental issue raised in my testimony. I contended that Federal Reserve policy is mostly guided by some vague unspecified ideas and inchoate notions which often conflict with each other. More specifically, the Federal Reserve's policymaking lacks the rational foundation which a coherently formulated and validated conception would supply. There is no evidence indicating that the Federal Reserve authorities have seriously attempted to systematically explore the structure of the monetary processes and thus supply the substantiated analysis necessary for rational policy decisions. It is therefore most encouraging to notice Governor Mitchell's ap-

<sup>1</sup> A correction in Governor Mitchell's report of my lecture appears necessary. I did not express my astonishment about "some of my academic colleagues for presenting arithmetical relationships without demonstrating their relevance to economic and policy issues." My lecture was entitled "Fashions or Knowledge," and dealt with the changes in our opinions concerning the efficacy of monetary policy. In particular, I considered whether or not the long cycles observed in our opinions are the result of substantiated analysis. The fundamental contention of the lecture denied this surmise and I asserted particularly that we usually moved in a fashionlike manner prone to psychological suggestive but logically irrelevant impressionisms. Three specific cases were developed: (i) The accrual of excess reserves in the thirties' and the assertion of a breakdown in monetary policy, (ii) the apparent decline in the relative importance of banks and the lowered effectiveness of monetary policy, and (iii) the comparative variability of velocity and the resulting impairment of monetary policy. It was then shown that in all cases some observations were adduced as evidence in support of a proposition denying the effectiveness of monetary policy or asserting a decline in its effectiveness. Moreover, in all cases a logical analysis reveals that these observations have no evidential value. Hypotheses can be constructed (some of them published in our work) which imply the denial of the propositions under considerations which are also consistent with the observations adduced. It follows that the observations listed have no relevant application, by themselves, to the appraisal of an effective monetary policy. My lecture dealt with proposition and their relation to discriminating observations and not with "arithmetical relationships."



proval of investigations designed to extend our systematic knowledge about the structure of monetary mechanisms. But the very proposals advanced by Governor Mitchell suggest to show that the Federal Reserve authorities do not know how to exploit the facilities at their disposal in a manner conducive to enlarging their relevant knowledge. He advocates more detailed investigations concerning "cyclical changes in the structure of money ownership or on the role of turnover as it affects the demand for money."

The Federal Reserve has on major occasions been prone to collect data without any guiding, purposeful idea. The collection of data exhibiting the ownership distribution of deposits supplies a good example. In order to establish the relevance of such costly collections, the resulting data should be shown to bear immediately on a hypothesis concerning the structure of monetary processes. Such hypotheses may conceivably be formulated and excellent results could conceivably be achieved. This remains to be seen. However, in view of the limited resources available and the lack of reliable knowledge stressed by Governor Mitchell, it would appear rational to adjust the collection and preparation of data according to a plan designed to cover the most urgent gaps in our policy foundations. This procedure requires that the range of phenomena bearing most directly on important policy issues be delineated, that several hypotheses covering this range or various subranges be carefully and explicitly formulated, and ultimately, that these hypotheses be patiently assessed by repeated and competitive exposure to observations.

It should be noted that the second proposal points to potentially relevant material. Unfortunately, its formulation is dangerously misleading and could seriously vitiate the construction of suitable hypotheses. But I welcome the Federal Reserve's growing awareness of a demand behavior for money and the recognition that extensive investigations promise to yield important information applicable to rational policymaking. I particularly hope that Governor Mitchell will launch a detailed investigation into the structure of velocity and demand behavior which will be successfully implemented by the Board's Research Division.

One important range of problems, however, is missing among Governor Mitchell's suggestions. More than 10 years ago the Federal Reserve authorities acknowledged in a report to a congressional committee that its basic functions center on the control of the money supply. Effective control presupposes the possession of relevant knowledge concerning the structure of the process generating the observed behavior of the money supply. There is little evidence that the Federal Reserve authorities have acquired the reliable knowledge necessary for an effective control over the money supply. On the contrary, there is considerable evidence that they are still enmeshed in serious misconceptions. I find the absence of any suggestions indicating the urgency of better founded conceptions about the money supply process somewhat disturbing, most particularly when the chart discussed by Governor Mitchell in a lengthy footnote occurred, with the exception of a single sentence, in the context of considerations applied to the money supply process.

(ii) However, even a single sentence is sufficient to justify critical attention. Governor Mitchell's statement appears to suggest that I engaged in some arithmetical legerdemain. But his elaborations miss some essential points.

(a) It is perfectly legitimate to advance an empirical hypothesis asserting a causal connection leading from the growth rate of the money supply to the pace of economic activity represented by turning points located independently of the money supply. Such a hypothesis has been formulated by the sentence alluded to. I would not wish to argue the richness of its detailed informative range, but I do acknowledge its usefulness as an explanation for the economy's broadest contours.<sup>2</sup> The observations adduced do bear on this hypothesis and are not an artifact with respect to this hypothesis. The assertion that they are an artifact can only mean that an alternative hypothesis implying the denial of the systematic character of the asserted regularity is better confirmed. But Governor Mitchell presents no case yielding such a result even approximately.

(b) Moreover, Governor Mitchell's criticism is subject to various interpretations: (1) He possibly means that the observations adduced, while relevant, possess very little discriminating power. or (2) he may wish to suggest that discriminating observations sharply differentiating rival ideas could only be

<sup>2</sup> I used the hypothesis for the first time at a forecasting seminar in November 1956 organized by the School of Business Administration at UCLA. The hypothesis was used to predict the occurrence of a turning point located in the middle of 1957.

specified with the aid of a theory which explains the empirical hypothesis postulated.

The table appended to Governor Mitchell's statement suggests the first interpretation. The table exhibits the annual percentage changes of five different magnitudes (industrial production, money supply, nonagricultural employment, private nonfarm residential construction, and new orders for durable goods). If Governor Mitchell wishes to have any meaning attached to this procedure, he must implicitly wish to draw attention to alternative hypotheses explaining turning points in economic activity in terms of one or more of the series on nonagricultural employment, private nonfarm residential construction, or new orders for durable goods. These alternative specifications might assert that the money supply's behavior observed in the same chart results directly or indirectly from the gyrations in the chosen nonmonetary causal entity. But the major portion of my written statement bears on this very point. I summarized some results of the money supply theories investigated by Professor Meltzer and myself. We have shown that under the base hypothesis the extended base (monetary base plus cumulated sum of reserves liberated from or impounded into required reserves by changes in legal ratios) dominates the money supply. Moreover, the extended base is controlled by a set of circumstances not systematically dependent on current economic activity. In particular, under present arrangements it is determined by policy actions. Thus an explanation of the money supply by means of a money supply theory extends the range of observation bearing the causal direction of monetary processes.

Several money supply theories with radically different structure have been investigated in our project. The major implications coincide and emphasize the decisive role of the extended base. These theories have also been sufficiently tested to reveal their empirical relevance. These results have been published and presented at professional meetings for public exposure. Moreover, these results were summarized partly in my written statement and the underlying studies referred to in the footnotes. This analytical underpinning and the associated evidence is disregarded by Governor Mitchell. This analysis and evidence support the empirical hypothesis mentioned above as against the alternatives implicitly submitted to the committee for consideration. We do not contend that our money supply theories are in any sense final and conclusive. We do hope that improvements emerge from mutual appraisal of one's hypotheses. But the Federal Reserve authorities still have to show an awareness of the very problem involved.

The second interpretation leads us to an important problem. It is quite true "that the way in which changes in money supply generate changes in economic activity has (not) been sufficiently thought through and empirically tested." The detailed nature of the so-called transmission mechanism has not been reliably traced and still poses a challenge to our searching inquiry. An appropriate theory of this mechanism might explain the comparatively simple hypothesis indicated above. Such explanation would occur in a context which assigns more discriminating power to the observations adduced. We thoroughly agree with the request for a clearly articulated conception of the transmission mechanism. It should be noted, therefore, that we have formulated a detailed theory and also presented one of its implications bearing on Governor Mitchell's objection.<sup>3</sup> In view of the analytical underpinning actually provided, the objection becomes groundless. Such underpinning does not "establish" the causal structure of the monetary mechanism, but it does supply an interpretation and provides a frame which guides our evaluations.

Lastly I wish to emphasize another point related to Governor Mitchell's objection concerning my discussion of a causal relation linking money and economic activity. His comments fail to mention that I supplemented the observation he discussed with other evidence. As a matter of fact, I referred explicitly to detailed analysis and evidence emanating from our research project. Both the

<sup>3</sup> I mentioned this point explicitly in the discussion following my lecture in the Fed's Research Division. Somebody raised a well-taken point concerning the significance of simple hypotheses of the type discussed. I indicated that a searching evaluation would require the formulation of a higher level theory which enables us to squeeze more relevant information bearing on the causal structure out of a given sample of observations. I also indicated that this reason led Professor Meltzer and myself to formulate a higher level theory which implied the regularity asserted by the simple hypothesis. I also referred to the paper summarizing our theory: "The Place of Financial Intermediaries in the Transmission of Monetary Policy," American Economic Association, May 1963. The implication referred to and the appropriate regression occur in footnote 12.

evidence and the analysis strongly support the contention of a causal relation from the money supply to the behavior of economic activity.<sup>4</sup>

(iii) Two more comments remain to be clarified at this point. Governor Mitchell finds that I provided no "proof" or "demonstration" for the causal relation under consideration. Such requests can never be satisfied. No empirical theory can be "proved" or "demonstrated," but we can assess its comparative performance and thus its measure of confirmation.<sup>5</sup>

Moreover, footnote 2 of Governor Mitchell's opening statement asserts that I "nowhere indicate the economic rationale for working in terms of year-over-year changes." The reader should note that these annual increments of monthly data exhibited in charts I and II of my written statement were used to discuss the dependence of the money supply on the extended base. Annual first differences between corresponding months have desirable statistical properties. They effectively remove multicollinearity between the determinants of the money supply while remaining sufficiently large relative to the unavoidable chance variations cast up by the process. Furthermore, they partly avoid serious problems associated with potential distortions introduced by many seasonal adjustment procedures. Lastly, annual increments of monthly data usefully describe the relative shift in the Federal Reserve's policy between corresponding months. These shifts are sufficiently sharp and thus permit a more decisive evaluation of the Federal Reserve's policy assessments.

2. The criticism addressed to my alleged championship of an "invariant rule" occurs in the context of a section which "counsels against the recommendation" of a definite and constant growth rate of the money supply. I regret that Governor Mitchell seriously misread my testimony.

First, I did not propose a constant or even invariant growth rate of the money supply. I did propose however the growth rate of the extended base be stabilized. In particular, I contended that there exists no rationale, founded on any systematic knowledge that we currently possess, which yields a justification for the wild gyrations in the growth rate of the extended base. Moreover, no rationale has ever been provided by the Federal Reserve authorities beyond useless metaphors (leaning against the wind, proceed on an even keel etc.). Three points were specifically emphasized in my written and oral testimony.

(a) Monetary policy should be designed to remove the unnecessary and harmful gyrations in the growth rate of the money supply which were mostly due to the Federal Reserve's policy behavior.

(b) In particular, monetary policy should avoid the occurrence of sustained growth rates in the money supply below 3 percent per annum.

(c) My position was further elaborated in my answers to one of the questions posed by Congressman Pepper. I indicated that I considered the choice between a rule on the one side and discretionary management on the other to form an issue of secondary importance. The dominant and primary issue must be recognized in the misconceptions about the money supply process guiding the Federal Reserve's policy evaluations. I cannot attach much importance to the choice discussed by Governor Mitchell under the prevailing circumstances. The primary problem remains the Federal Reserve's overt preference for basing policy decisions on vague, unsubstantiated, and conflicting notions and justifying them with the aid of metaphors. Contrary to Governor Mitchell's contention, I neither advocated an invariant growth rate nor am I very much interested in this issue at the present stage.

The oral response to Congressman Pepper's question also presented the reason for my relative disinterest in this problem. I noted that under both regimes appropriate and validated knowledge about the structure of the monetary process was required. I doubt that a rule will be very useful if the Federal Reserve authorities do not know how the money supply process operates. They are still guided by a conception which leads them to believe that they are "stimulative" when they are actually deflationary. Under these conditions the imposition of a rule might very likely yield a situation where the Federal Reserve authorities would feel justified to assert that the money supply is uncontrollable. The

<sup>4</sup> Governor Mitchell does not deny the existence of a causal relation from money supply to economic activity. This acknowledgement of the causal relation occurs in the context of his criticisms of my chart I. I fully agree that this chart provides only weak evidence indeed concerning the causal relation discussed. But where is Governor Mitchell's evidence? Or what is his hypothesis explicating the nature of this causal relation?

<sup>5</sup> This point was also emphasized in the discussion following my lecture in response to some question raised.

Federal Reserve would still have to know how to behave in order to manage the money supply in accordance with the rule. Such knowledge can only be provided by a carefully constructed and validated theory.

A similar argument applies to discretionary management. Judgment must also be relevant, and this relevance can only be obtained from a validated theory. Thus before the issue between "rules and discretion" can be fruitfully considered, the problem of relevant knowledge must be faced by the Federal Reserve authorities. I regret that this question, the fundamental issue, has been avoided by Governor Mitchell and replaced by an issue I had explicitly assigned a secondary and derivative position. I venture to assert that this secondary problem will not continue in the presently polarized form, once the Federal Reserve authorities have acknowledged their responsibility and learned to exploit their Research Division effectively in order to obtain the systematic knowledge required for their policy decisions.

3. Even with the assignment of a second order relevance to the issue "rules versus discretion," the argument used by Governor Mitchell to dispose of a "rigid rule" is worth same examination.

(a) He argues that a policy following the Friedman rule would have led to a smaller expansion in "credit" (?) since 1961 than actually occurred in subsequent years. Governor Mitchell chose, as it happens, the bottom of a downswing for his base period. It would be easy to select numerous other periods and obtain the opposite result. The crucial point is that Governor Mitchell selects an upswing from a total pattern of instability in growth rates of bank credit and money supply created by the Federal Reserve's policy. Having made this selection he suggests that Friedman's rule would have been inadequate to assure the recovery observed.

The choice between rules or discretionary management rationally depends on our evaluation of the consequences to be expected under the alternative monetary arrangements. The Federal Reserve's established behavior yields sufficient information to constrain the actual choice available under prevailing circumstances between some rules on the one side and the procyclic movement of the growth rate in the money supply on the other. Such procyclic movement is difficult to justify without denying the causal relation from money to economic activity. These patterns were essentially generated by the inherited behavior of a well-established organization. It is therefore only reasonable to expect that an acknowledgment by this organization of the causal relation discussed previously must be inherently difficult even in the face of mounting evidence. Among the contributions of a more rationally founded conception of the money supply process we could expect a radical modification of the substance involved in a choice between "rules" or "discretionary management." The force of a coherent and validated conception might alter "discretionary management" so that it would perform according to some modified rule characterized by some measure of "built-in" flexibility. Under these new conditions the rules advanced whether "invariant" or "flexible" would center on the common requirement of a comparatively stable growth rate in the money supply and specifically remove the inherited procyclic pattern. It should also be noted in this context that the differential movements in the exclusive and inclusive money supply so sharply focused in recent years would become negligible, if the prohibition or regulation of interest payments to owners of checking and time deposits is terminated.

(b) Governor Mitchell also adduces the nature of our imperfect knowledge, and particularly the absence of any "demonstrated constancy" in "degree and timing" of the causal relation as another reason counseling rejection of a "rigid rule" concerning the growth rate of the money supply. There is no doubt concerning the imperfect nature of our knowledge, an imperfection extending to "degree and timing" of the causal relations. But such acknowledgment does not yield the result suggested by Governor Mitchell. In particular, the deplored uncertainty of our knowledge provides no rationale for "judgment and thought." Such judgment is no more reliable than the uncertain knowledge used in its support. Or does Governor Mitchell seriously contend that the gyrations in the growth rate of the money supply produced under a regime of "judgment and thought" is better than a growth rate maintained within a narrower range? However, this suggestion would not be compatible with the admission that there exists a causal connection leading from monetary processes to economic activity. Such a causal connection implies that prevailing Federal Reserve policy is essentially destabilizing.

Moreover, the Federal Reserve authorities convey an impression that they continuously adjust in policy to evolving circumstances. Such a conception

makes eminent sense if there exists reliable knowledge concerning the structure of the process operated upon by policy. But Governor Mitchell emphasizes the highly imperfect nature of our knowledge about the transmission mechanism. The exercise of fine judgment has thus simply no basis, at least no cognitively relevant basis. Continuous application of fine judgment can only be rationalized in a context where the detailed structure of the transmission mechanism is reliably known. In the absence of such detailed and validated knowledge it seems doubly important to avoid the gyrations of the money supply observed in the past. I submit that the stabilization of the growth rate of the money supply is quite feasible. This feasibility depends on the expectation that our competition is likely to yield an adequate conception of the money supply process in the near future. This conception will be expressed by a theory sufficiently confirmed and relevant to provide a rational foundation for policy, and particularly for comparatively fine and continuous adjustments of policy bearing on the money supply.

In view of the knowledge situation just described, Governor Mitchell's last paragraph is somewhat surprising. Arguments in favor of a "rigid rule" are equated with a "surrender of the intellect and abandonment of the objectives of scientific inquiry." Moreover, proponents of a rule are described to advocate employment of the Federal Reserve's vast powers "without thought, judgment, discretion, and concern for the world as it is."

Little need be said with respect to the emotively appealing but otherwise unsupported assertion that a rule implies "a surrender of the intellect and abandonment of the objective of scientific inquiry." The short analysis presented above summarizing my position with respect to the issue "rules versus discretion" indicated the importance of appropriate knowledge under either arrangement. The assertion quoted is strange indeed when we consider that it is made by a representative of an institution whose policies are not the results of scientific inquiry—at least until March 1964. And with respect to the other objection addressed to proponents of a rule, I wonder what the Federal Reserve's evidence of thoughtlessness, absence of any judgment, discretion, and concern for the world actually is. Professor Meltzer and I are convinced that the Federal Reserve authorities are deeply concerned with the world, that they continuously apply earnest judgment, discretion, and thought. We have no doubts on this score. But we doubt most emphatically the relevance of this judgment and thought. In particular, we submit that it is not based on any validated conception of the monetary process. In short, we ask, What is the conception guiding the Federal Reserve's policy? Where has it been coherently and explicitly formulated, and where has it been stated in a manner conducive to the "objective of scientific inquiry" and thus in a form permitting systematic appraisal by competitive exposure to observations? And lastly, where and when has it been actually appraised by more than subjective "personal experience"? Only when these questions can be successfully answered with clearly formulated statements and supporting evidence can we intelligently choose between alternative conceptions and provide the foundations for a national policy.

(Whereupon, at 12:20 p.m., the subcommittee was in recess, to reconvene at 10 a.m., Thursday, March 5, 1964.)

# THE FEDERAL RESERVE SYSTEM AFTER 50 YEARS

THURSDAY, MARCH 5, 1964

HOUSE OF REPRESENTATIVES,  
SUBCOMMITTEE ON DOMESTIC FINANCE OF THE  
COMMITTEE ON BANKING AND CURRENCY,  
*Washington, D.C.*

The subcommittee met, pursuant to recess, at 10 a.m., in room 1301, Longworth House Office Building, Hon. Wright Patman (chairman) presiding.

Present: Representatives Patman, Reuss, Vanik, Moorhead, Minish, Hanna, Kilburn, Widnall, Harvey, Bolton, Brock, and Taft.

The CHAIRMAN. The committee will please come to order.

Today we are going to hear from Secretary Dillon. I had hoped we would have had the benefit of his comments in January, right after we heard from Chairman Martin. The Secretary was unable to testify at that time because of the tax bill, and other pressing matters, but I am glad he is here today.

Secretary Dillon was not scheduled to be our last witness in January, and he will not be our last witness in March. We want to hear from as many experts on our Nation's money system as we possibly can, so that in deciding on the merits of the bills before us, we will have the benefit of a complete and comprehensive record. So next week we have scheduled more economists, including:

Dean George Bach, of Carnegie Tech, who is also a director of the Pittsburgh Federal Reserve Branch Bank, and Clark Warburton, who has had many years of experience in one of the greatest of our banking institutions, the FDIC, and is one of the most knowledgeable public servants in the Federal Reserve System.

But today we will hear from Secretary Dillon. Before we do, however, I would like to take a moment to comment briefly on certain remarks by Governor Daane yesterday, on the likelihood of abuses when you combine the monetary and fiscal powers under a single authority. Governor Daane recounted his experience in Paraguay, and I think there is a crucial lesson for us to learn from this that goes to the heart of the issues before the subcommittee regarding our own need for having our monetary authorities more responsive to the electorate.

The point is simply that these grave abuses in the State of Paraguay, described by Governor Daane, occurred under one of the toughest little dictatorships ever known in this hemisphere, where the money managers are not responsible nor accountable to the electorate. There simply is no electorate.

Now here in America, by contrast, we do have an electorate. But are we really fulfilling the promise of our wonderful free society?

How can this be if those controlling our money supply are not clearly responsible to the people, if not directly then through their duly elected representatives?

I would like the record to show that this episode in Paraguay supports the stand that where there is less political accountability, then monetary policy is more subject to abuse and the long-run public and national interests are poorly served. I am sure that more will be said on this subject as the hearings progress.

Mr. Secretary, we will place in the record at this point your statement, and if you will summarize it over, say 10 or 15 minutes, we will have more time to ask questions, it will be appreciated.

The request is made in view of the fact that we must get through here by noon. Surely, you do not want to come back if you can help it. You are a very busy man. We do not want to come back if we can help it.

We must go to the floor to take up the interest equalization bill which has been reported out by the Ways and Means Committee, which you are interested in, too, of course.

If you will just proceed in your own way, sir, we will appreciate it very much.

(The complete statement of Secretary Dillon referred to follows:)

#### STATEMENT OF HON. DOUGLAS DILLON, SECRETARY OF THE TREASURY

Mr. Chairman, my testimony today will be limited to what I have experienced during my 3 years as Secretary of the Treasury. That is the only period in which I have had any close contact with the Federal Reserve System or with the operations of our commercial banking system.

##### FEDERAL RESERVE-TREASURY COOPERATION

It is difficult for me to conceive of any closer working relationships between two coordinate agencies of Government than those that have characterized the Treasury and the Federal Reserve during the past 3 years. That does not mean that our policy judgments always coincide any more than do, for instance, the policy judgments of the individual Governors who sit on the Federal Reserve Board. But I believe that each agency has been fully informed at all times on the problems and policies of the other, and worked closely together in coordinating their separate actions.

I have always found the officials of the Federal Reserve eager to learn of our special problems and quick to cooperate within the bounds set by their own primary responsibility for regulating the supply of money and bank credit according to their own best appraisal of prevailing economic circumstances. This common understanding and cooperation has been of great help to me as the chief fiscal and financial office of the Government and in my direction of our international financial relationships.

Cooperation has been reflected in a number of informal relationships that, by their presence through several administrations, are now a matter of course. Every Monday, for instance, the Chairman of the Board of Governors visits the Treasury to discuss current issues and problems with me, and my associates. Every Wednesday, the Chairman, together with other Governors and members of his staff,

meet at lunch with the Under Secretary for Monetary Affairs and his associates to discuss matters of mutual interest. More formally, certain aspects of international policy are cleared through the National Advisory Council under my chairmanship. These relationships have been further bolstered by free and continuous exchange of information between the staffs of the Treasury and the Federal Reserve.

In addition, Presidents Kennedy and Johnson have continued the practice of meeting from time to time with the top financial officials of the administration. Chairman Martin has participated fully in these discussions. He cannot, of course, bind the Federal Reserve to a decision that is within the province of his Board or of the Open Market Committee. But he is always willing to convey his own appraisals and judgments to us. These conferences also enable him to interpret accurately and sympathetically the administration's objectives and policies to his own Board and to the Open Market Committee, so that those groups may have the benefit of this information in arriving at their own decisions.

This process of close consultation and cooperation cannot be attributed entirely to a happy accident of congenial personalities or to a fortuitous coincidence of objectives. Its foundation rests solidly upon the fact that the Federal Reserve is bound by the same broad objectives, cited in the Employment Act of 1946, that govern the operations of other Government agencies.

#### FEDERAL RESERVE INDEPENDENCE

From time to time, suggestions have been made that coordination of financial policy should be enforced by various devices. Such a proposal is contained in one of the bills before you—H.R. 9631—which would make the Secretary of the Treasury *ex officio* Chairman of the Federal Reserve Board.

This proposal seems to me to raise most important questions of public policy, for inevitably the implication is that the stature of the Federal Reserve—*independent* not of the Government, but of the Treasury—would be, to some degree, diminished.

Demands on the time of any Secretary of the Treasury are already heavy. Added responsibilities for the formulation and execution of monetary policy would compete with his responsibilities in other areas. Delegation of a large portion of these new responsibilities to his subordinates—and that could hardly be avoided—would in turn raise further questions about whether the critical and complex issues of monetary policy were receiving the attention they deserve. It is one thing for the Secretary of the Treasury to be continually aware of the general nature and direction of monetary policy, and to keep in close touch with the Chairman of the Board of Governors on the issues that seem most significant—as I now do. It is quite another to be responsible for the vast and complex activities of a very intricate operating organization.

Proposals of this kind also raise the possibility that decisions on monetary policy, directed toward the overall health of the economy, will at times, consciously or unconsciously, be biased by the constant pressures on the Secretary of the Treasury to assure the economical financing of the dominant borrower in our economy—the Federal Government itself. This does not mean that the Federal Reserve



should not or does not properly take into account the financing needs of the Federal Government in determining its own policy. These Treasury-financing operations have important implications for financial markets generally, and in their common pursuit of a vigorous and healthy economy the Federal Reserve and the Treasury share a common interest in the orderly financing of Government. But occasions would, of course, arise in which almost any Secretary of the Treasury could feel a conflict between his immediate interest in insuring a successful financing and the broader objective of maintaining a supply of money and credit in tune with the needs of the economy as a whole.

Finally, and perhaps most fundamental to a resolution of this issue, experience over many years and in many countries has taught the wisdom of shielding those who make decisions on monetary policy from day-to-day pressures. The day of private central banks operating without regard to Government policy is long since gone, and quite properly so. But around the world, almost all countries still find it useful to maintain independence for their central banks within the Government.

Independence naturally implies the right to disagree; and not only to disagree, but to act on the basis of different judgments. Some differences between the Treasury and the Federal Reserve may from time to time be a fact of life. But this need not be distressing. The necessity to test policy proposals against the views of an independent Federal Reserve is, I believe, the best insurance we can have that the claims of financial stability will never be neglected.

In considering this problem of achieving a proper balance, I share the view of the present Chairman of the Board of Governors that the Chairman's term of office should be made coterminous, or more nearly coterminous, with that of the President. With a President free to choose a new Chairman upon taking office, or shortly thereafter, there will be firm institutional basis for expecting that the kind of cooperative relationship that has characterized the past 3 years will continue in the future, and that the viewpoints and aims of an incoming administration will be sympathetically reflected in the councils of the Federal Reserve. Two years ago, President Kennedy made precisely such a proposal to the Congress. It was valid then and it remains valid today. I commend it to your attention.

#### THE INTERNAL STRUCTURE OF THE FEDERAL RESERVE

The bills before you raise a number of other specific issues concerning the internal structure of the Federal Reserve, including the composition of the Board, the usefulness of the Federal Open Market Committee, arrangements for appropriate audits, and the methods of covering its necessary expenditures. I will not dwell upon these issues at length for they raise a number of detailed questions of organization upon which I have no special competence.

In approaching questions of this kind, however, I do feel strongly that we should remain mindful of the relevance of one of President Wilson's remarks at the time the Federal Reserve System was established 50 years ago. He noted then that the sponsors of that legislation were dealing "with our economic system as it is and as it might be

modified, not as it might be if we had a clean sheet of paper to write upon."

This Committee is dealing with a living institution—an institution that has demonstrated its capacity to innovate, to experiment, and to adapt itself to a very wide range of circumstances. But in this process of change, it has never lost certain characteristics—an established tradition of independent judgment; a mixture of regional participation in policymaking with ultimate central control that is unique in our Government; an ability to attract highly qualified officials and staff; and a reputation for operating efficiently and impartially.

The structure that has resulted does not fit easily into the framework of standard tables of organization. Policy responsibility is widely dispersed and coordination depends in part on informal working relationships built up over the years. Vestigial elements of an earlier conception of private participation in central banking policies—elements that are more symbolic than real today—are still visible.

But change without clear purpose can be dangerous too. If there are persuasive reasons for particular proposals—if it can be shown that ownership of Federal Reserve bank stock by member banks has biased Federal Reserve policy decisions, or if budgetary or auditing practices have been loose, to take two examples—by all means, this committee should act. But I doubt the advisability of taking action simply for the sake of achieving symmetry with other Government agencies, particularly if there was danger that such action might impair a long tradition of regional participation and efficient service of which I believe the country can be proud.

Personally, I would be inclined to the view that if any change is made in the composition of the Board itself, it might better be made smaller rather than larger. I would also think that consideration might usefully be given to some shortening in the present 14-year term for Board members, as well as to the elimination both of the current special geographical restrictions on Board membership and of indications that members should be representative of particular interests.

In the same vein, I should also express my firm support for the efforts now underway to lift the salaries of Board members along with those of other Government officials. This is the appropriate path toward reducing the present anomalies—so evident within the Federal Reserve System itself—that have left Board members with salaries far below the more competitive rates paid not only in industry but within the Federal Reserve System itself.

#### OTHER ISSUES

Three of the bills before your committee—H.R. 9686, H.R. 9687, and H.R. 9749—raise issues of general financial policy rather than of the administrative structure and independence of the Federal Reserve itself.

The first of these, which would require the payment of interest on treasury tax and loan accounts, is the most limited in scope. This matter, as you know, has been carefully reviewed at intervals by the Treasury Department. We now have underway a new and comprehensive study of the facts both on bank earnings that can be attribu-

table to these accounts and on bank expenses in handling transactions of the Government. This study, which I hope will be completed by July, will shed further light on this matter.

However, in appraising the tax and loan account system, I think it is vital to keep in mind that these arrangements were basically designed not as a method to reimburse banks for services performed but to fill a special need in our decentralized financial system, characterized by a large number of independent banks. These arrangements perform a twofold function. First, the use of tax and loan accounts avoids abrupt flows of deposits from one section of the country to another, as well as disturbing contractions or expansions in the total of bank reserves, that would otherwise be an unfortunate byproduct of the large, day to day cash and borrowing operations of the Treasury. Second, the tax and loan account system makes it possible for commercial banks to underwrite and distribute new Treasury securities—an indispensable element in the smooth market absorption of many new cash offerings.

I know of no arrangements in foreign countries that have been more successful in minimizing and cushioning the effects of Treasury operations on the money markets, even though in many of those countries a highly centralized banking system makes simpler the task of forestalling disturbing flows.

Any effort to seek a precise balancing of costs and earnings that emerge from the mutual relationships of the Treasury and the banks that would directly or indirectly impede these basis functions of the tax and loan account system would be self-defeating.

I would be happy to have Mr. John Carlock, who as Fiscal Assistant Secretary is directly in charge of the Treasury depository arrangements, provide you with a more detailed review of these matters at your convenience.

Much broader issues of monetary theory and practice are raised by the proposal of H.R. 9687 that we reverse the Banking Acts of 1933 and 1935 and permit banks to resume payment of interest on demand deposits. This approach was fully explored by the President's Committee on Financial Institutions. However, the majority of the committee concluded in its report filed last year that the dangers and difficulties posed by such a change, particularly for smaller banks outside of the financial centers, outweighed any potential advantages. I joined in that majority finding.

The final bill, H.R. 9749, would commit the Federal Reserve to support the yields of all Government securities at rates no higher than  $4\frac{1}{4}$  percent. This would, in my judgment, represent a departure from the principles of flexible and vigorous monetary and credit policies.

In my judgment, efforts to peg interest rates by governmental decree, or to hold them below a predetermined level, represent an unrealistic simplification of what can in fact be done, or properly attempted by any governmental authority. We want interest rates to be as low as possible. We want to remove any props that artificially hold rates above the levels that supply and demand in competitive markets would produce. We want the influence of Government constructively used, wherever there is room for choice, on the side of lower rates. But I think that to make a fixed level of interest rates the sole objective in any circumstances would prevent the Federal Reserve from doing

most of the other things that we expect it to do—in avoiding inflation, or averting boom-bust cycles, or assisting sustained growth. The contribution that flexible interest rates and monetary policies can make to growth without inflation are so great that we must place no artificial restrictions of this kind on Federal Reserve operations.

Before closing, I would like to suggest to the committee two areas in which outmoded restrictions in the Federal Reserve Act have clearly outlived any usefulness they might once have had, and today unnecessarily constrict the flexibility with which the Federal Reserve can discharge its domestic and international responsibilities.

The first of these areas concerns the archaic requirements defining the paper eligible for securing advances to member banks.

At the present time, as you know, the Federal Reserve can freely lend to member banks at the prevailing discount rate only on the basis of Government securities or commercial paper meeting certain rigid legal requirements in its maturity, purpose, and “self-liquidating” character. In recent years, a much larger proposition of the Government security holdings of many banks has been needed to secure public deposits or for other purposes that effectively forestall their use in borrowing from the Federal Reserve. The supply of other paper meeting the technical eligibility requirements of the Federal Reserve Act has also declined as the character of bank lending has changed over the decades, and in any event the use of this paper for borrowing would require awkward and cumbersome procedures by both commercial banks and the Federal Reserve.

The necessity for banks to maintain assets that meet these restrictive eligibility requirements in a volume adequate to provide a reasonable margin over foreseeable needs could become an impediment in the flexible distribution of bank credit among competing uses. Moreover, shortages of eligible paper could potentially affect the ability of the Federal Reserve to make credit promptly available at reasonable terms to its members when required. Unless these eligibility requirements are relaxed, the time could come that the flow of credit from banks to consumers, homebuyers, and businesses requiring medium-term credit would be unnaturally constrained. Doubts might unnecessarily arise over the ability of the Federal Reserve to relieve any sudden pressures effectively and expeditiously. I urge that you give your early attention to removing this anachronism from law.

A somewhat parallel rigidity in the law is beginning to affect the ability of the Federal Reserve to meet its growing responsibilities in the international financial area. The Federal Reserve banks, as they acquire foreign currencies, can place these funds abroad only in bank deposits or in commercial paper of limited classes and restricted availability. For years, these restrictions were of no practical import, in view of the limited amount of foreign currencies held by the System. But, the Federal Reserve is now resuming operations in a variety of foreign currencies on a larger scale and participating widely in the network of reciprocal currency agreements and other arrangements that have emerged from the increasing cooperation among monetary authorities in recent years. Consequently, the need for greater flexibility is apparent.

By permitting the foreign currencies acquired to be held in a wider variety of safe and liquid money market instruments—including, in particular, foreign treasury bills—the Congress would be taking an

important new step to further strengthen the international monetary system and the position of the dollar.

Clearly, perfection cannot be claimed for either the Federal Reserve Act, which became law more than 50 years ago, or the Federal Reserve System as it has evolved within the framework of that law. As in the past, the effective adaptation of the Federal Reserve to the needs of today and tomorrow will require that the Congress be willing to search out and eliminate faults and anachronisms that hamper effective performance. But, I would also urge this committee, in undertaking that necessary task, to protect and preserve those elements in the structure of the Federal Reserve that underlie its special strength and stature at the center of our banking system.

### STATEMENT OF HON. DOUGLAS DILLON, SECRETARY OF THE TREASURY

Secretary DILLON. I will be glad to, Mr. Chairman.

I wanted to open my statement by saying that my testimony is based on my experience as Secretary of the Treasury only, in the last 3 years, because prior to that time I had had no close contact with the Federal Reserve System or with commercial banking practices in any detail. My previous experience had been in the investment banking business, which is something quite different.

In my statement I point out, in the opening parts of it, that in the 3 years that I have been in the Treasury the cooperation and understanding between the Treasury and the Federal Reserve have been very close.

This does not mean necessarily, that our ideas coincide at every moment, but we have always fully informed each other of what policies there are and the differences have not been at all major. In fact, there have probably been stronger differences within the Federal Reserve System, between individuals, than may be between the Treasury and the Federal Reserve as a whole.

The Federal Reserve, during this 3-year period, has always been attentive to Treasury policies and needs and to the desires of the administration.

This cooperation was carried out by regular weekly meetings that I have had every Monday with the Chairman of the Board of Governors and my staff, headed by the Under Secretary for Monetary Affairs, who goes over to the Federal Reserve one other day every week, and they meet together and talk in considerable detail.

In addition, both Presidents Kennedy and Johnson have met with top financial officials of the administration, including the Chairman of the Federal Reserve Board, from time to time, and this has afforded very useful opportunities for the President to make his views known and to elicit the thinking of the Chairman.

While the Chairman cannot bind the Board, because the actions of the Board are by majority vote—as are also the actions of the Open Market Committee—certainly it has been very useful to have him informed closely on administration policy, and I am sure he has carried that back and given it to the Open Market Committee and the Board and it has been reflected in their actions.

I think that the main reason for this is that, as we see it, the Federal Reserve is bound, just as much as we are, by the broad objectives of the Employment Act of 1946.

Now we come to the more specific things, which is the question of "independence" and particularly the bill, H.R. 9631, which would make the Secretary of the Treasury the ex officio Chairman of the Federal Reserve Board.

This proposal seems to me to raise very serious questions of public policy, for inevitably the implication is that the stature of the Federal Reserve, independent not of the Government but of the Treasury, would be to some degree diminished.

Also, demands on my time are already very heavy and if I had, in addition, the responsibility for both the formulation and the execution of monetary policy it would be impossible for me to carry these responsibilities out without fairly extensive delegation, and I do not know whether that would be proper, to turn the complex and critical problems of monetary policy over to subordinates.

It is one thing for me to be continually aware, as Secretary of the Treasury, of the general nature and direction of monetary policy and to keep in close touch with the Chairman of the Board of Governors, as I now do.

It would be quite another thing for me to be responsible for the vast and complex activities of a very intricate operating organization.

Also, I think there is the very real possibility that, in making decisions on monetary policy, the Secretary of the Treasury would at times, consciously or unconsciously, be biased by the constant pressures upon him to assure the most economical financing of the Federal Government.

The Federal Reserve pays attention to this, of course, but they fit it into their own policy. It is as important to them as it is to us that our financing operations are successful. But if the control of both financing and overall monetary policies rested in one person, I think there would undoubtedly be times when any Secretary would have a feeling of conflict between his immediate interest in insuring a successful financing and the broader objectives of monetary policy.

Finally, and perhaps most fundamental to a resolution of this issue, experience over many years and in many countries has taught the wisdom of shielding those who make decisions on monetary policy from day-to-day pressures. The day of private central banks operating without regard to Government policy is long since gone, and quite properly so. But around the world, almost all countries still find it useful to maintain independence for their central banks within the government.

Independence naturally implies the right to disagree; and not only to disagree, but to act on the basis of different judgments. Some differences between the Treasury and the Federal Reserve may from time to time be a fact of life. But this need not be distressing.

The necessity to test policy proposals against the views of an independent Federal Reserve is, I believe, the best insurance we can have that the claims of financial stability will never be neglected.

In considering this problem of achieving a proper balance, however, I think improvements can be made, and I share the view of the present Chairman of the Board of Governors that the Chairman's term of office should be made coterminous, or more nearly coterminous, with that of the President. With a President free to choose a new Chairman upon taking office, or shortly thereafter, there will be firm institutional basis for expecting that the kind of cooperative relationship

that has characterized the past 3 years will continue in the future, and that the viewpoints and aims of an incoming administration will be sympathetically reflected in the councils of the Federal Reserve.

Two years ago, President Kennedy made precisely such a proposal to the Congress. It was valid then and it remains valid today. I commend it to your attention.

The other bills before you raise specific issues concerning the internal structure of the Federal Reserve, including the composition of the Board, the usefulness of the Federal Open Market Committee, arrangements for appropriate audits, and the methods of covering its necessary expenditures. I will not dwell upon these issues at length for they raise a number of detailed questions of organization upon which I have no special competence.

However, I do think that we should bear in mind, in dealing with this, that this is a living institution that has demonstrated its capacity to innovate and to change, and which has maintained an established tradition of independent judgment, a mixture of regional participation and policymaking, with the ultimate central control here in Washington, which is unique in our Government, and it has shown an ability to attract highly qualified officials and staff and has had the reputation for operating impartially and efficiently.

So I think, in making changes, the burden of proof is more or less on those who wish to make this change to show that something worthwhile will be accomplished.

Policy responsibility is widely dispersed and coordination depends in part on informal working relationships built up over the years. Vestigial elements of an earlier conception of private participation in central banking policies—elements that are more symbolic than real today—are still visible.

As I said, a change without clear purpose can be dangerous too. If there are persuasive reasons for particular proposals—if it can be shown that ownership of Federal Reserve bank stock by member banks has biased Federal Reserve policy decisions, or if budgetary or auditing practices have been loose, to take two examples—by all means, this committee should act. But I doubt the advisability of taking action simply for the sake of achieving symmetry with other Government agencies, particularly if there was danger that such action might impair a long tradition of regional participation and efficient service of which I believe the country can be proud.

Personally, I would be inclined to the view that if any change is made in the composition of the board itself, it might better be made smaller rather than larger. I would also think that consideration might usefully be given to some shortenings in the present 14-year term for board members, as well as to the restrictions on board membership and of indications that members should be representative of particular interests.

This is because I think you might get higher and more able people, and these restrictions may somewhat inhibit the search for such people.

In the same vein, I should also express my firm support for the efforts now underway to lift the salaries of Board members along with those of other Government officials. This is the appropriate path toward reducing the present anomalies—so evident within the Federal Reserve System itself—that have left Board members with sal-

aries far below the more competitive rates paid not only in industry but within the Federal Reserve System itself.

I noted, in passing, that on the list that was made public the other day there were 14 employees of the Federal Reserve Board in Washington listed there with salaries that are higher than either the Chairman or the members of the Board, and there are probably many more, because this stopped at the level some \$2,000 above the salary paid the Board members.

Three of the bills before your committee—H.R. 9686, H.R. 9687, and H.R. 9749—raise issues of general financial policy rather than of the administrative structure and independence of the Federal Reserve itself.

The first of these, which would require the payment of interest on Treasury tax and loan accounts, is the most limited in scope. This matter, as you know, has been carefully reviewed at intervals by the Treasury Department. At the suggestion of Senator Douglas, we now have underway a new and comprehensive study of the facts both on bank earnings that can be attributable to these accounts and on bank expenses in handling transactions of the Government. This study, which I hope will be completed by July, will shed further light on this matter.

However, in appraising the tax and loan account system, I think it is vital to keep in mind that these arrangements were basically designed not as a method to reimburse banks for services performed but to fill a special need in our decentralized financial system, characterized by a large number of independent banks. These arrangements perform a twofold function.

First, the use of tax and loan accounts avoids abrupt flows of deposits from one section of the country to another, as well as disturbing contractions or expansions in the total of bank reserves, that would otherwise be an unfortunate byproduct of the large, day-to-day cash and borrowing operations of the Treasury. Second, the tax and loan account system makes it possible for commercial banks to underwrite and distribute new Treasury securities—an indispensable element in the smooth market absorption of many new cash offerings.

I know of no arrangements in foreign countries that have been more successful in minimizing and cushioning the effects of Treasury operations on the money markets, even though in many of those countries a highly centralized banking system makes simpler the task of forestalling disturbing flows.

Any effort to seek a precise balancing of costs and earnings that emerge from the mutual relationships of the Treasury and the banks that would directly or indirectly impede these basic functions of the tax and loan account system would be self-defeating.

Now, Mr. Chairman, if you desire, later in your hearings, to go into this in greater detail, I would be happy to have Mr. John Carlock, our fiscal Assistant Secretary who is directly in charge of the Treasury depository arrangements, provide you with a more detailed review of these matters at your convenience.

Much broader issues of monetary theory and practice are raised by the proposal of H.R. 9687 that we reverse the Banking Acts of 1933 and 1935 and permit banks to resume payment of interest on demand deposits. This approach was fully explored by the President's Committee on Financial Institutions.



However, the majority of the Committee concluded in its report filed last year that the dangers and difficulties posed by such a change, particularly for smaller banks outside of the financial centers, outweighed any potential advantages. I joined in that majority finding.

The final bill, H.R. 9749, would commit the Federal Reserve to support the yields of all Government securities at rates no higher than 4½ percent. This would in my judgment represent a departure from the principles of flexible and vigorous monetary and credit policies.

In my judgment, efforts to peg interest rates by governmental decree, or to hold them below a predetermined level, represent an unrealistic simplification of what can in fact be done, or properly attempted by any governmental authority. We want interest rates to be as low as possible. We want to remove any props that artificially hold rates above the levels that supply and demand in competitive markets would produce.

We want the influence of Government constructively used, wherever there is room for choice, on the side of lower rates. But I think that to make a fixed level of interest rates the sole objective in any circumstances would prevent the Federal Reserve from doing most of the other things that we expect it to do—in avoiding inflation, or averting boom-bust cycles, or assisting sustained growth.

The contribution that flexible interest rates and monetary policies can make to growth without inflation are so great that we must place no artificial restrictions of this kind on Federal Reserve operations.

Finally, I would like to suggest to the committee two areas in which outmoded restrictions in the Federal Reserve Act have clearly outlived any usefulness they might once have had, and today unnecessarily constrict the flexibility with which the Federal Reserve can discharge its domestic and international responsibilities.

The first of these areas concerns the archaic requirements defining the paper eligible for securing advances to member banks.

At the present time, as you know, the Federal Reserve can freely lend to member banks at the prevailing discount rate only on the basis of Government securities or commercial paper meeting certain rigid legal requirements in its maturity, purpose, and “self-liquidating” character. In recent years, a much larger proportion of the Government security holdings of many banks has been needed to secure public deposits or for other purposes that effectively forestall their use in borrowing from the Federal Reserve.

The supply of other paper meeting the technical eligibility requirements of the Federal Reserve Act has also declined as the character of bank lending has changed over the decades, and in any event the use of this paper for borrowing would require awkward and cumbersome procedures by both commercial banks and the Federal Reserve.

The necessity for banks to maintain assets that meet these restrictive “eligibility” requirements in a volume adequate to provide a reasonable margin over foreseeable needs could become an impediment in the flexible distribution of bank credit among competing uses. Moreover, shortages of eligible paper could potentially affect the ability of the Federal Reserve to make credit promptly available at reasonable terms to its members when required. Unless these eligibility requirements are relaxed, the time could come that the flow of credit from banks to consumers, homebuyers, and businesses requiring medium-term credit

would be unnaturally constrained. Doubts might unnecessarily arise over the ability of the Federal Reserve to relieve any sudden pressures effectively and expeditiously. I urge that you give your early attention to removing this anachronism from law.

A somewhat parallel rigidity in the law is beginning to affect the ability of the Federal Reserve to meet its growing responsibilities in the international financial area. The Federal Reserve banks, as they acquire foreign currencies, can place these funds abroad only in bank deposits or in commercial paper of limited classes and restricted availability.

For years, these restrictions were of no practical import, in view of the limited amount of foreign currencies held by the System. But, the Federal Reserve is now resuming operations in a variety of foreign currencies on a larger scale and participating widely in the network of reciprocal currency agreements and other arrangements that have emerged from the increasing cooperation among monetary authorities in recent years. Consequently, the need for greater flexibility is apparent.

By permitting the foreign currencies acquired to be held in a wider variety of safe and liquid money market instruments—including, in particular, foreign Treasury bills—the Congress would be taking an important new step to further strengthen the international monetary system and the position of the dollar.

Finally, I just want to say that perfection cannot be claimed for either the Federal Reserve Act, which became law more than 50 years ago, or the Federal Reserve System as it has evolved within the framework of that law. As in the past, the effective adaptation of the Federal Reserve to the needs of today and tomorrow will require that the Congress be willing to search out and eliminate faults and anachronisms that hamper effective performance. But, I would also urge this committee, in undertaking that necessary task, to protect and preserve those elements in the structure of the Federal Reserve that underlie its special strength and stature at the center of our banking system.

Thank you.

The CHAIRMAN. Thank you, Mr. Dillon. Mr. Reuss?

Mr. REUSS. Thank you, Mr. Chairman.

Mr. Secretary, in your paper this morning, you referred to our balance-of-payments problems which, as you know, has been a longtime interest of mine.

I have noticed in the press in recent weeks that you have indicated your concern that European countries, by unnecessarily increasing their own domestic interest rate structure, could embarrass our balance-of-payments picture by affecting U.S. capital movements.

I want to congratulate you for speaking out on that subject. I think that is very much in the public interest.

Despite what you said, I know that some of the countries did raise their interest rates. However, at least in the case of the United Kingdom my understanding is that the Bank of England is now purchasing Treasury bills, which are particularly the instrument that is bought by Americans and others who might want to get out of dollars and get into pound sterling. Because of that, I gather that the effects of the interest rate increase in the United Kingdom are not likely to be

very heavily felt on our balance of payments and our short-term capital outflow. Is that too optimistic a view?

Secretary DILLON. No, we would hope not.

We had the opportunity to discuss this thoroughly with the British and make available to them our views on the dangers of an interest rate structure that would disturb the international monetary system by drawing funds out of the United States, and I think they full agreed with that.

Indeed, in the announcement of the Bank of England, when they raised this discount rate, they said it was not intended to draw foreign funds into the United Kingdom and, through a variety of means, they can certainly minimize those movements and I think you have pointed to one of them.

The fact remains that the week after that change the covered cost of investment in Treasury bills still favors the United States over London by a very small fraction.

Before this change it favored our market by about one quarter of 1 percent or slightly more, and now it is practically level except for a slight three or four basis points, or five basis points, in favor of New York.

But there is no pull the other way, and I think that is the general objective, to try and maintain that sort of situation.

If they can maintain that sort of a situation then I do not think there will be any real problem.

Mr. REUSS. And by not presenting any real problem I take it, and I hope that you mean there will be no movement here to raise our own interest rates?

Secretary DILLON. Yes. That is what I stated in the statement which the Treasury made on this action of the Bank of England, that there was nothing to change our present policies in that respect.

Mr. REUSS. Yes. As I say, I think you all did an excellent job on that.

Turning to another aspect of our balance of payments, the Euro-Dollar market and particularly the European banks which now hold large numbers of dollars. Would it not be a good thing for this country and for our balance of payments if those foreign banks would use, their Euro-Dollar resources to a much greater extent than they now do, to make loans to U.S. corporations and other borrowers? By so using their dollars, they would prevent them from falling into the hands of the central bank which can demand gold for them.

They might also be induced to acquire additional dollars and sell francs or marks or whatever they have for that purpose.

It would serve the further purpose of tending to keep interest rates in this country somewhat lower than they would be without this additional supply of capital.

It is not, therefore, altogether a good thing for this country when foreign banks make dollar loans within the United States?

Secretary DILLON. Well, certainly, one of the chief benefits of the Euro-Dollar system is that it has made funds available at lower interest rates than might otherwise be the case. That market operates on a very small margin—a smaller margin than our own banks have been used to operating on.

To the extent that our own companies could borrow in that market cheaper than they could borrow in New York or elsewhere in the United States, I would agree with you. I think it would be very fine.

Mr. REUSS. Particularly for the balance of payments?

Secretary DILLON. Yes.

Mr. REUSS. I understand that London Euro-Dollar brokers, who constitute a fairly large proportion of the total, need to obtain permission from the Bank of England before they may operate in the United States. Is that your understanding, too?

Secretary DILLON. I am not aware of that, but it may well be so. I can answer that for the record.

Mr. REUSS. I would appreciate your doing that.

If it turns out to be so, would it not be a good idea to make a remonstrance to—

Secretary DILLON (interrupting). I will be glad to look into that.

Mr. REUSS (continuing). To some of the people in the Bank of England?

Secretary DILLON. I will be glad to look into that.

Mr. REUSS. That is, to see if they could not open that up a little bit more?

(The information referred to follows:)

The information available to us here, which we have informally confirmed with the Bank of England, indicates that that Bank does not require lenders of Euro-dollars in London to obtain permission from it before making loans to U.S. concerns. In fact, when Euro-dollar interest rates are sufficiently attractive, U.S. concerns here, and their subsidiaries abroad, do avail themselves of the facilities of the Euro-dollar market. They may do this both directly and through American banks which hold Euro-dollar deposits of their branches. The Euro-dollar market does, therefore, now exert an influence on U.S. rates and the availability of capital from this source competes with U.S. sources of capital. It must be remembered, however, that the United States is also a lender in the Euro-dollar market and this market can, therefore, both attract and supply capital in competition with U.S. sources.

Mr. REUSS. The final question I have concerns the negotiations now going on looking toward the development of a more effective international monetary system, which negotiations stem from the decisions taken at the International Monetary Fund meeting in Washington in last October.

I am not asking you to say in public the exact status of these negotiations, but I would ask you this: Is there a United States position which we are now putting forward?

Secretary DILLON. There is a general United States position that has been established by consultation within the administration. Whether we have fully put it forward in the group yet, I am not certain because conversations have been exploratory in nature within the group up to this date. I think that that exploratory stage has now about been finished.

I think probably at the next meeting they will really get down to cases on what they are going to recommend, and at that time, most certainly, our basic position will be available and will be put forward.

Mr. REUSS. I certainly would like to communicate to you again, as I have before, my sense of urgency about this because I think so many of our interest rate problems, so many of our balance-of-payments problems, stem from the fact that here in a world in which capital among the free nations happily can move freely from country to country, we have allowed this pleasant situation to construct what individual countries can do about dealing with unemployment and inadequate growth. So, I cannot think of a more important item.

I recognize the delicacy of negotiations when you have 10 or more countries that you are sitting down with. However, the Congress will ultimately have to approve whatever is arrived at.

I would like to ask you this: In accordance with the Vandenberg formula, by being in on the takeoff as well as the landing, would it be possible for you to communicate in private, if you prefer, to such members of this committee as are interested, and the chairman—

Secretary DILLON. I think the—

Mr. REUSS (continuing). What the United States position is?

Secretary DILLON. I think we could certainly do that in confidence, as you say.

How successful we will be in accomplishing our objectives, I do not know. The program that was set forth originally was to try to have a report by the deputies—who are working on this problem and who have been working very hard on it ever since last fall—in proper form for the ministers to meet on, and either to agree on or to agree on in part for their governments, by some time in the early summer. I think, when we get into the position of coming up to that firm agreement, it would be very appropriate and proper for us to consult with the appropriate committees, including this one.

So far as the more immediate and preliminary United States position is concerned, I do not think there is any reason why we could not have confidential discussions on a limited basis, but it is very important obviously, from a negotiating point of view, to keep those confidential.

Mr. REUSS. Of course, and I very much approve the course you are taking. My time is about to expire, but in these negotiations it is my view, at least, that we ought to put forth a wholehearted United States position which will, as far as we are concerned, do the job that needs to be done; if we cannot get any votes for it, well, that is too bad, but I do not think we should—

Secretary DILLON. Well—

Mr. REUSS (continuing). Aim at the lowest common denominator right at the start.

Secretary DILLON. Well that, of course, raises a basic question—whether it is best to aim at perfection and to get nothing or whether it is best, knowing what you want is perfection, to be willing to accept something less than that, but which is a substantial improvement in the system. There have been very few times in history—maybe Bretton Woods, right after the war, which is the only time that I know of—when there was a really major sort of change in the system.

Otherwise, international payments mechanisms have tended, I think, rather naturally because of the many countries involved, to evolve rather gradually. I think we want a favorable outcome. I think it will be through a sort of evolution that we will get definite progress in the system and that, at this time, we will not reach a totally new and perfect system.

Mr. REUSS. Well, I would leave with you my hope that we will at least aim for a whole loaf, and if we have to settle for a half a loaf, take the half a loaf.

I would hope, however, that we would not aim for a half a loaf and have to take an eighth of a loaf. Thank you, Mr. Chairman.

The CHAIRMAN. Mr. Widnall?

Mr. WIDNALL. Thank you, Mr. Chairman.

Mr. Secretary, I have listened very carefully to your testimony. Now, am I correct in understanding that none of the bills, pending before the committee right now, that we are considering are administration proposals?

Secretary DILLON. That is correct. I think the Bureau of the Budget stated that they had no position, no administration position, on any of these bills.

Mr. WIDNALL. I am very pleased—

Secretary DILLON. I think the only one that would be an administration position—and it is a carryover from the previous Congress—is the recommendation of President Kennedy providing for appointment of the Chairman of the Federal Reserve Board coterminous with the President.

I understood that yesterday—

Mr. WIDNALL. That is not before us at this time, Mr. Secretary.

Secretary DILLON. No; it is not before you at this time. It was introduced by Mr. Spence in the last Congress. It has never been introduced in this Congress.

Mr. WIDNALL. And, incidentally, as you pointed out in your own testimony, Mr. Martin, the Chairman of the Board, said he agreed to the coterminous feature.

Secretary DILLON. Yes; he supports that, including the provision for a vacancy to occur on the Federal Reserve Board with each presidential election; so the coterminous feature would not be limited to the President choosing among the particular members of the Board, but would also give him the right to appoint a new member.

There has been a bill introduced in this session of the Congress which carries out only half of that. It was introduced by Mr. Multer, and allows the President to choose among the current members of the Board. But that was not President Kennedy's proposal, which went beyond that.

Mr. WIDNALL. Mr. Secretary, I think it has been fine for the record to have your statement displaying the fine cooperation and coordination of effort that has taken place between the Federal Reserve and the President of the United States and the Secretary of the Treasury.

It seems to me that constantly through the hearings there has been the thread of a charge that everything is done in secret and the President of the United States has no knowledge of what is going on and the public has no knowledge of what is going on, the administration had no knowledge of what is going on, and that that is a little oligarchy that is doing everything just the way they want to do it.

Now, on the contrary, as I understand your views, you say that there has been a continuous flow of information back and forth and the seeking of information on the part of all involved that has worked out very well during the past years?

Secretary DILLON. Yes. We have these weekly meetings, as I say, as well as continual staff contacts; I meet with the chairman on Monday, which, it just so happens, is always the day before a meeting of the Open Market Committee, so he can discuss with me, and he does discuss with me, the problems that he thinks will come before that meeting the next day.

And then we are informed of the general tenor of what happened at the Open Market Committee immediately after it is finished.

Mr. WIDNALL. During the course of Mr. Daane's testimony yesterday he stated:

I have seen at first hand in other countries the dangers involved in downgrading or subordinating monetary policy.

It was after that statement that he mentioned Paraguay as an instance that he thought of off-hand which he admitted himself might be a little bit in the extreme, but I wondered if you might have any illustrations in connection with that that would be helpful to the committee or if you felt that you could submit some information later—

Secretary DILLON. I think I had rather try to submit some.

It is generally now accepted that central banks should operate with a considerable measure of autonomy. That is the case in Great Britain. It is even more so in Germany, where the central bank has at least as much autonomy as the Federal Reserve System here.

It is the case in Italy. It is the case, to a somewhat less extent, in France. And so it seems to be a generally accepted practice in the world, but I would like to take a look and see if there are good cases that can be made to show that a lack of autonomy resulted in central banks being utilized strictly to help finance the government, and that inflation has resulted.

Of course, we have had that sort of thing in past history much more. I think generally the world has come to the point where it is now recognized that stability and the fight against inflation is very important, and that is the reason for this independence within a government.

Now, I do not say that central banks should be independent of the Government, and I feel very strongly that they should not be, and are not. I know that the Federal Reserve considers itself part of the Government. It was created by Congress. The members of the Board are Government officials.

And they are bound by the laws of the country, by the Employment Act, and so forth.

So I do not think that there is room for a central bank outside of the Government, as was originally the case in our early history with the Bank of the United States when we had a private central bank—totally private. I think we have passed way beyond that. Such things do not exist in any leading country any more, and I do not think they should here.

(The following statement was supplied for the record:)

War periods in most countries have illustrated the predominance of considerations of government finance over considerations of monetary and price stability in the determination of central bank policies. Central banking systems, under war conditions when governments have been unable to raise the revenues needed, have often provided for government requirements through expanded note issue, the creation of deposit liabilities for the government, or an expansion of bank reserves. This monetary expansion occasioned by fiscal requirements has sometimes also entailed the expansion of credit to the private economy with the result of an added pressure on prices. In this sense we have had an undue monetary expansion in the United States related to the exigencies of Government finance and the consequent central bank accommodation of the Government, and there have been similar experiences with the European governments.

Perhaps more significant are instances when, under peacetime conditions, governments have put pressure on central banks to finance government deficits, with a consequent undue increase in the supply of money and inflationary repercussions. The classic example is Germany. Inflation in Germany began in

1914, as a result of war financing, continued throughout World War I, and then accelerated, especially from 1921 on, as a result both of fiscal policy and the expansionary monetary policy of the Reichsbank. At the height of the inflation, the 12-month period, from July 1922 through June 1923, domestic prices rose approximately 18,000 percent. At the same time, and as an explanation of the phenomenal rise in prices, money in circulation rose almost 9,000 percent, mostly attributable to an increase of 7,000 percent in the floating debt. During this same period, budgetary expenditures exceeded receipts by approximately 2,800 million gold marks, and the Reichsbank continued to discount an ever-increasing volume of Treasury bills. Six successive increases in the discount rate—from 6 to 18 percent—were not sufficient to offset the inflationary consequences of these purchases of Government debt, as the Reichsbank went through the forms of monetary restraint but not the substance.

There are also more recent European cases; for example, France and Greece in the period following the Second World War. The method of financing the heavy state expenditures during the years immediately following the war contributed greatly to inflationary pressures in France, and made it difficult for the Bank of France to control the course of inflation. In 1952, for example, when the Government budget amounted to nearly 35 percent of the national income, 41 percent of the total increase in the money supply was created by direct advances to the Government by the Bank of France and the acquisition of Government securities by the central bank and the commercial banks.

In the postwar period up to 1953 the Bank of Greece expanded the note issue to meet the demands of the Government to finance its budgetary deficit. The note issue increased from 104 billion drachmas at the end of 1945 to a high point of 2,971 billion drachmas. In this period loans from the Bank of Greece to the Government increased from 85 billion drachmas to 8,766 billion drachmas. Along with the expansion of credit to the Government there was an expansion of credit to private entities to bring the total note issue in September 1953 to 6,401 billion drachmas and the total loans of the Bank of Greece to 12,244 billion drachmas. Symptomatic of increased prices was the fall in the external value of the drachma from 502 to the dollar to 30,100 drachmas to the dollar.

There are a number of illustrations in Latin America. Government and central bank relationships in Paraguay in 1950 were discussed in Governor's Daane's testimony on March 4, 1964. That experience predated the present Government. In Brazil, the Government's cash deficit has grown annually until in recent years it has amounted to half of revenue receipts, and this deficit has been covered in substantial part through currency issued by a Government board through the Bank of Brazil, which is not a central bank with independent powers of control. Within the existing arrangements it has been practically impossible to control either public or private credit, with the result that the inflation in Brazil was 50 percent in 1962 and 80 percent in 1963.

Earlier postwar experience in Argentina, similarly illustrates the danger of excessive Government borrowing from the central bank, which had been made an instrument of the Finance Ministry. Between 1945 and 1955, there was a deficit each year and the cumulative deficit came to 35 billion pesos, of which 20 billion pesos were financed by bank credits. Total bank credits increased from 12 to 89 billion pesos and cash in the hands of the public from 8 to 52 billion pesos. In this period of time the cost of living increased more than 500 percent.

In September 1960, the new government in Ecuador initiated an extremely expansionary policy. Within 9 months central bank credit increased 50 percent, with the bulk of the increase occasioned by lending to the Government. This resulted in the only major price increase in 10 years. The central bank lost most of its foreign exchange reserve and there was a massive flight of capital from the country. In November of 1961, a new government permitted the central bank to undertake the necessary credit measures and after a time price stability was achieved and public confidence revived.

The New Zealand Central Bank was originally established as an independent central bank in 1933. In 1936 the bank's functions were redefined to place more emphasis on assistance to government financing, and beginning in 1938, the bank began to make large direct advances to the government to finance government deficit expenditures. The rise in these advances was paralleled by an outflow of private capital, necessitating the establishment of the tight import and exchange controls. Since the bank was made responsible to the Minister of Finance in 1939, its legal status has not been changed. In practice, however, there has been a gradual increase in the bank's use of a flexible monetary policy.



The examples, which have been cited, do not emerge uniformly from differences in the formal legal status of central banks. Monetary policy, whatever the precise institutional framework, should be and, in greater or lesser degree has been, responsive to national goals and policies of various countries. However, most governments have, in practice, concluded that a degree of independence for the central bank can contribute to developing and strengthening national attitudes and traditions regarding the importance of monetary stability. This practice and tradition in the United States is formally reflected in the legal framework of the Federal Reserve System.

Mr. WIDNALL. I think the members of the committee appreciate your constructive suggestion with respect to eliminating what you call the archaic requirements defining paper eligible for securing advances to member banks.

I believe a similar suggestion had been made earlier in the testimony by others who have testified.

Secretary DILLON. That bill was submitted by the Federal Reserve last August and my statement here can be taken as administration support for the general principles in that request.

Mr. WIDNALL. That is all at this time, Mr. Secretary.

The CHAIRMAN. Yes. Mr. Vanik?

Mr. VANIK. Mr. Secretary, carrying through with the question that Mr. Widnall had directed to you, concerning the reaction of the Bureau of the Budget, would you say that the position of the Bureau of the Budget was in opposition to this legislation or would you say that it is a position of indifference?

Secretary DILLON. I would say it is neither. It is simply that there has not been developed a detailed administration position on any of these bills. This requires a long and fairly detailed procedure on complicated matters of this kind in which they seek the views of all of the interested agencies and then try to work out a unified position.

They just have not had the time to do that, and they have not really been asked to do that. So, therefore, they have just stated the plain fact that they have no position.

I did submit my statement to the Bureau of the Budget, and they did clear it, but I do not think that should or was meant to indicate the position I took on these individual things necessarily would be a final position if they were asked to develop one. But they found no objection to those positions.

Mr. VANIK. Then we may expect that the administration position will be forthcoming?

Secretary DILLON. If we are asked. If we are asked.

If I understand that the committee wants that, I will try to get it.

Mr. VANIK. Well, I want it. I do not have the authority to demand your position. I suppose that would be up to the committee, but I would like to have it.

Secretary DILLON. I should think it is up to the committee.

Mr. VANIK. I would like to be guided by the administration position, and I would like to know what the arguments are pro and con.

Now, in your concept of the Federal Reserve Board you reaffirm its independent status.

As an administrative agency it makes a private appraisal of facts, as I understand it, and then makes decisions which have a far-reaching effect upon the economy of the Nation.

Now, what concerns me is the system under which the facts are privately gathered and assessed and in which enormous decisions are secretly arrived at.

I wonder if we have not approached the point where the gathering and the assessment of the facts by the Fed should not be made more of a public matter and that its decisions should not be determined by clear-cut guidelines or criteria which should be developed by regulations in the administrative process, so that Congress, the administration, and so that your office and the public could test from time to time the validity of these guidelines as well as their objectivity.

Secretary DILLON. Well, I think the basic guidelines are laid down by the Employment Act—

Mr. VANIK. I am talking about the Fed now, before they are motivated into an alteration of the rediscount rates. Shouldn't this kind of a decision result from a process which dictates action when certain conditions are reached. We can test these conditions, so that it just is not an arbitrary thing. Decisions should emerge by rule of law or an established regulatory process which indicates that when certain conditions are met a certain action will result by the Fed, so that there is less discretion and more certainty in its action and when it will come?

Secretary DILLON. I think there are two problems there, Mr. Vanik. One is that it is very hard to foresee every particular time when some action, either up or down, should be taken with respect to the discount rate, for instance, or in open market policy. I think it is essential to have full freedom and flexibility of operations and not be hampered in that by any rigid guidelines.

The other problem, which is a market problem, is that any system which would give advance—clear-cut advance—information that action was likely to be taken on such and such a date would cause very substantial perturbations in the market. This is not the case now because the market can react only after action is taken.

Mr. VANIK. Do you not agree, Mr. Secretary, that most of the people know just about what is going to happen?

There seem to be people in the trade who know the fluctuations of the economy and can almost anticipate to the hour when action will be taken by the Fed. Only those not familiar with its history and its processes are caught by surprise.

I would say that within the trade and in the finance circles the movements of the Fed, and almost all of its actions, are almost pretty well anticipated.

Secretary DILLON. I am not sure of that. I think there are times when you are quite right, but not always.

I think many of those in the banking business, particularly in the commercial banking business in New York, have felt for some time that there was a clear case from their point of view for a more restrictive policy on the part of the Fed, and the Fed hasn't seen it that way and has operated the other way.

So I do not think they have foreseen the policy of the Fed very successfully.

Mr. VANIK. Let me ask you: Suppose there was a situation which would arise in which you would violently disagree with some action that the Fed was taking or was about to take. What would you do about it?

Secretary DILLON. Well, under the present law, if they feel they want to go ahead, there is nothing to be done.

I think the only way of assuring that that would not happen is to insure that you have a Chairman of the Federal Reserve Board who is sympathetic to the aims of the administration and does work with that administration.

And I think that the bill making the term of the Chairman coterminous and giving a new President the right to appoint a new member of the Board who could be Chairman either immediately or shortly after—and by “shortly” I mean within a matter of 2 or 3 months after his inauguration—would greatly lessen the possibility of anything like that happening.

If such a thing happened nevertheless, of course there is always a chance that the Secretary of the Treasury might be the one that was wrong.

Mr. VANIK. Well, is that Chairman enough? He just has one vote.

Secretary DILLON. That is right, but he has a strong influence, and I think that all the members of the Board do feel—and I have talked to some of them, not all of them because I do not personally work intimately with the whole Board—that it is very important for the monetary authority to work with and not against the basic policies of the administration in office, whatever that administration may be.

And I think, in a way, that the actions of the Federal Reserve System in these last 3 years, as compared to its actions in the years before, are partly a reflection of that.

Mr. VANIK. Well, it seems to have a capacity to blend or to accommodate the administration.

Secretary DILLON. That is right.

Mr. VANIK. That seems to be one of its characteristics.

Secretary DILLON. Whichever administration may be in—

Mr. VANIK. But can you conceive of a situation where the Fed may take some very, very tremendous action and the barn would burn down, and we would be pretty powerless to do anything about it except to try to correct it on the next go-around?

Secretary DILLON. It is theoretically possible, yes.

Mr. VANIK. Supposing Congress passed a law, requiring the Federal Reserve Board to support Government securities at prices so that no yield would go above 4¼ percent, and we would also, in the same legislation, require banks to hold a reserve at a fixed percentage of demand deposits.

The reserve would consist of variable proportions of cash and Government securities.

Would this stabilize the price of the Government securities at a decent interest rate without contributing to inflation or without impeding the power of the Fed to control inflation or the ups and downs in the economy?

Secretary DILLON. Well, I think most of the time the Fed certainly could operate adequately within such a limit, and it would not be in effect. There would not have to be any stabilization because that is a reasonably elevated rate of interest over a period of time.

However, certainly occasions would likely arise when—for at least brief periods when one got into an inflationary period—there was a great demand for money and for loans, and it would be in the interest of stable growth to hold back that inflation by restricting credit to some extent. And the Federal Reserve would not be able to restrict credit at all, because—

Mr. VANIK. Well, do you say "restricting credit" in the sense that you would compel an increase in bank reserves?

It is a very effective way of holding the credit line.

Secretary DILLON. You mean that would put the flexibility there and have that run up and down.

Mr. VANIK. That is right. In other words, the debt cost would remain a constant item and the people of the United States would be the beneficiaries of that, and you control inflation simply by changing reserve requirements, which would seem to be a very logical and constructive way to do it because it would, in a sense, impound that free capital and keep it from getting reckless.

Secretary DILLON. Well, that might or might not work. I see the theoretical point as to how it might in some instances, but not being a monetary expert in detail myself, I would prefer not to express an opinion on just how workable that system would be.

Mr. VANIK. Well, it is possible that we can have someone in the Treasury—

Secretary DILLON. Oh, yes, I would be glad to do that. I would be glad to send you a comment for the record.

Mr. VANIK. I am no better a monetary expert than you, Mr. Secretary.

Secretary DILLON. Well, I think my Under Secretary for Monetary Affairs has probably had a little more experience in this sort of thing, and I would be glad to—

Mr. VANIK. I think it would be helpful to us in connection with this legislation that we are considering.

Secretary DILLON. That will be fine.

Mr. VANIK. My time has expired.

(The following statement was supplied for the record:)

This proposal suggests that the Federal Reserve take action to prevent the market yields on Government securities from rising above  $4\frac{1}{4}$  percent, presumably at any time and presumably for an obligation of any maturity, whether short or long. Of course, much of the time, interest rates on Government securities could be expected to remain below these levels without any special support. For those periods when interest rates generally were rising, and the spreading pressures caused the yields on some Government securities to rise above  $4\frac{1}{4}$  percent, the proposal contains a further suggestion. That would be to have the Federal Reserve increase reserve requirements in order to offset any undue inflationary effect of the additional Federal Reserve credit created through the Federal Reserve purchases of Government securities—purchases which would be made in sufficient volume to hold yields on Government securities at or below  $4\frac{1}{4}$  percent while other rates were rising.

Several technical possibilities might be considered for attempting such a program. One would be to raise the overall level of reserve requirements against demand deposits as an offset to any undue expansion of bank reserves created by the Federal Reserve purchases. Another might be to redesign existing reserve requirements so that they would consist of both bank balances held on deposit at the Federal Reserve banks and some of the Government securities owned by the commercial banks themselves. Or there might be some combination of both approaches.

All such possibilities have, of course, been considered and analyzed within the Government at various times in the past. In general, the conclusion has been that efforts of any form along these lines would in practice be self-defeating. The Treasury Department would still support that view. Some of the principal considerations in the Treasury's appraisal are the following:

Whatever the combination of techniques selected, the aim would be to maintain a support price for Government securities (that is a ceiling on their yields) whenever general credit conditions should move the entire structure of rates up to levels that would imply yields over  $4\frac{1}{4}$  percent on Government secu-

rities. In effect, any measures would have to attempt to isolate Government securities from the market forces of supply and demand then at work throughout the rest of the credit and capital markets. The end result would be the creation of a special market for Governments, consisting of the Federal Reserve banks alone, under the first technical possibility mentioned above, or the commercial banks under the second technique, or both if the two techniques were combined. This would mean that either the Federal Reserve banks or the commercial banks or both would in effect be required to buy Government securities at higher prices than would be consistent with the prices and yields prevailing for all other forms of credit.

Under such circumstances, with up to \$100 billion of marketable Government securities passing through the market for replacement each year, a very heavy burden of absorption would be placed on the Federal Reserve banks or the commercial banks who were required by law to purchase Government securities at the fixed prices "above the market." While the magnitudes need not be expected to reach the \$100 billion scale, of course, since presumably not all Government securities of all maturities would be under market pressure to rise above 4¼ percent at the same time, there would—if general credit conditions remained at all tight for very long—be a cumulative burden placed on the banks that could become seriously disruptive to their operations. There could indeed be serious impairment of their performance of all other functions required for the operations of the entire private credit mechanism.

As more and more of bank assets were immobilized in required reserves, private borrowers dependent upon bank financing would find sources of funds particularly constricted, and this would include many borrowers, such as small businesses, unable to readily seek funds elsewhere. The range of possible reactions and effects on the total supply and distribution of credit, if reserves were to be increased by varying proportions of the amount of Government securities purchased, would be very wide. But in general, the result of attempting to insulate the rates on Government securities from market forces, while at the same time limiting the total supply of credit, would be to concentrate the restrictive effects on those private borrowers with fewest alternative sources of funds and therefore in the weakest market position.

A policy of freezing the price level of Government securities at a time of heavy credit demands and expectations of higher rates could result in other investors "dumping" their holdings on the banking system. In that case Government securities would tend to disappear from public markets, very large increases in reserve requirements would have to be made, and the Treasury itself would be unable to market its debt except to the banks.

There would, in addition, be a number of technical complexities that would have to be worked out in determining the application of such new reserve requirements. What would happen, for example, if such requirements could not be applied to all commercial banks, but only to the present member banks of the Federal Reserve? Would it be correct to apply the same reserve requirements to banks of all sizes and all existing classifications, or should some pattern of differentiation be developed? What criteria could be inserted in legislation to guide the Federal Reserve in choosing between a general increase in reserve requirements and an increase in the special component of Government securities? What would happen to the Government securities already held by some banks that would exceed an average requirement for holdings of Government securities applied to all banks of a given size or a given class? Would these holdings, to the extent that they included issues whose prices were being supported, be aggressively sold—thereby adding to the volume of overall support needed to maintain the 4¼ percent yield level?

These questions are meant only to be illustrative of the technical problems that have been reviewed in connection with proposals of this kind. Since there are as well serious questions of principle, of the type outlined above, the Treasury Department does not consider as promising the proposal to combine the support of a 4¼ percent yield level on Government securities with a more flexible use of reserve requirements.

The CHAIRMAN. Yes. Mr. Harvey?

Mr. HARVEY. Mr. Secretary, I would like to refer back to one of Mr. Vanik's earlier questions and, to be sure that I understood your answer correctly, do I understand that as of now the administration

has not been asked for an opinion on these bills that are before us today?

Secretary DILLON. I do not think so. I was asked myself to be prepared when I came up today to comment on them—

Mr. HARVEY. But other—

Secretary DILLON. The Bureau of the Budget did not consider that a request for an administration position.

Mr. HARVEY. And so far as you know, no request has been made other than the request for you to come before us today?

Secretary DILLON. As far as I know, no.

Mr. HARVEY. Mr. Secretary, H.R. 9631 would change the number of members of the Federal Reserve Board from 7 to 12 by appointments by the President and with the advice and consent of the Senate, and it would reduce the term of office from 14 years to 4.

It would provide for the removal of any appointive member by the President at any time. It would add representation for labor and consumer interests to the present financial, agricultural, industrial, and commercial qualifications.

It would also make the Secretary of the Treasury a member and Chairman of the Board and, among other things, it would supplant the President's Federal Advisory Council of 12 by a council of 50 members.

Now, it seems to me that all of these features are clearly in H.R. 9631 and that they would make the Fed subservient to the administration.

Secretary DILLON. Not all of them. There is one provision in there that would change the strict rule of having to have each member come from a different Federal Reserve district to just saying they have to be broadly representative. I think that would be an advance.

We might go even further and abolish that restriction entirely, but I think that the President would want, in appointing people, to take into account the different areas of the country anyway.

As to this suggestion of adding a representative of labor and consumers, I think that if you do not abolish all of those criteria that there is just as good a reason for having representatives of labor and consumers as there is for having representatives of agricultural, commercial, industrial, and financial interests, which is the present—

Mr. HARVEY. Would you take a body of 50 as being as wieldy as a body of 12?

Secretary DILLON. Oh, no. On the numbers, I have indicated that we felt that a 12-man board would be too large to be effective. My own feeling is that the present seven-man board, might better be slightly reduced.

I think in general, the recommendation in this area of the Commission on Money and Credit for a five-member board with 10-year terms made a good deal of sense, although I do not think that is the only answer. I think if you want to make a change that would be a good one.

Mr. HARVEY. Would you agree that the other features that I cited would tend to make the Board or the Fed more subservient to the administration?

Secretary DILLON. Oh, I think many of them would. Of course, putting the Secretary of the Treasury in as Chairman would, and I

think the provision that all the members could be removed at any time by the President would do so also.

Mr. HARVEY. And I gather from your statement, just so we are clear on the record, that you would oppose that.

In other words, you are not in favor of those features?

Secretary DILLON. My own personal feeling, and the Treasury's feeling, is that those changes would be unsatisfactory, yes.

Mr. HARVEY. Chairman Martin, Mr. Dillon, suggested that there was an outright conflict of interest, if I recall his testimony, between the Secretary of the Treasury serving in two capacities inasmuch as in the one position it would be charged with borrowing money and in the other he would be charged with establishing monetary policy with regard to borrowing.

I gather from your statement, on page 5, that you agree also with that.

Secretary DILLON. Well, there is obviously that potential conflict. At times—and probably even a majority of the time—when you are in the actual operation there would not be any noticeable conflict. But undoubtedly from time to time there would be conflict and it would be a very difficult, if not impossible, situation from the Secretary of the Treasury to decide which way to go.

Mr. HARVEY. Mr. Secretary, on page 7 of your statement you skip over quite lightly the question—not “lightly” but quite quickly, the question of the GAO audit, and the question of where the Fed should get its appropriations from, and I can understand your reluctance to comment on these questions and yet I might say you are very modest insofar as your confidence is concerned in commenting on them.

They have become quite controversial questions before the committee because all of the Presidents, if I recall, of the Feds have indicated that both of these features, a GAO audit and submitting the Fed to the appropriations process of Congress as well, would both be steps down the road toward making the Fed more subservient to the administration and represent a loss of independence.

Would you care to comment insofar as those particular features are concerned?

Secretary DILLON. Well, I think the Treasury has always taken the position that it would be better not to have a Federal Reserve subject to the appropriations process because it does not fit into the mold of an ordinary Government agency.

It will be difficult to get the character or the type of professional appointees that they need there if they were subject to the regular appropriations. This is not anything unique in the Fed. None of the banking supervisory agencies of the Government are subject to appropriations. This also applies to the Comptroller of the Currency. It also applies to the FDIC. So the Fed is in that same situation.

So that is one, I think, that is fairly clear-cut. The Congress took that decision very deliberately, and I think it was a wise decision when it was taken.

As far as the GAO audit is concerned, I think that is somewhat a different situation. If Congress feels that the books of the Fed are not properly audited, or they have loose financial practices in keeping its funds, I see nothing wrong with having an additional audit, but it is really a question of whether it is a useful and necessary expense.

The GAO is not presently equipped to do this kind of thing. The Federal Reserve itself, the Board, has its own auditing outfit, I understand, which they have built up which does nothing but audit the Federal Reserve banks. It spends its whole time on auditing the individual banks on a very thorough basis. Then they have an outside private auditor come in and audit the Board itself, and also check up every year on the methods used to spot check their own audits.

Mr. HARVEY. Mr. Secretary—

Secretary DILLON. I think that is adequate.

I would think that that is generally adequate.

Now, the only problem with the GAO audit, continuous audit, is that the GAO goes far beyond—

Mr. HARVEY. It actually affects the policy, does it not?

Secretary DILLON. They try to in many cases, and I think that would be bad.

Mr. HARVEY. You think that part of it would be objectionable?

Secretary DILLON. Yes.

Mr. HARVEY. All right. Mr. Secretary, I have just about 1 minute here, I guess, left, and I have had several inquiries from bankers with regard to the shortage of coin.

Could you give us, in a nutshell, just a quick progress report on the mint at Philadelphia?

Can we expect anything fairly soon?

Secretary DILLON. No. It will take 2 or 3 years to build that new mint once we get the appropriations for it.

We submitted a supplemental request for \$500,000 so we could start drawing detailed plans as soon as the authorizing legislation was enacted. That was last November.

The Appropriation Committees have not yet acted on that, and so we have not been able to take any action and, because of that lack of action by the House Appropriations Committee, the coin shortage is now going to last another 6 or 8 months longer than it would have otherwise, and be that much more severe.

We also asked for supplemental appropriations this year so we can make more coins and put the mints really on an around-the-clock basis.

While everybody seems to agree that this is a fine idea for some reason that supplemental has not been voted.

So, therefore, again because of that delay in voting the supplemental, the shortage of coins is going to be much greater this coming winter than it otherwise would be.

Mr. HARVEY. Thank you, Mr. Secretary. I have no further questions at this time.

The CHAIRMAN. Mr. Minish?

Mr. MINISH. Thank you, Mr. Chairman.

Mr. Secretary, on page 3 of your testimony it says that Presidents Kennedy and Johnson have continued the practice of meeting from time to time with the top financial officials of the administration.

Chairman Martin, it says, has participated fully in these discussions.

How fully can he participate if he has to go back to the Board and the Open Market Committee for directions?

Secretary DILLON. Well, he can participate fully from the point of view of explaining the considerations that are topmost in the minds of both the Board and the Open Market Committee, because he meets



with the Board every day and with the Open Market Committee every 3 weeks.

And, therefore, it is not at all difficult for him in this sort of a meeting to either explain very clearly what he thinks their views would be or to take back to them the views of the President.

In cases where their views might be sharply split, he can make that clear. That would be the exceptional case, but he could make that clear and at times in these meetings he does so. He says, "We are not quite clear on this because there are two tendencies within the Board and within the Open Market Committee."

So I think it has been a very useful two-way thing, so that the President and the other financial officers of the Government understand what is motivating the Open Market Committee and the Board and what they are thinking about, and they, in turn, get absolutely straight first hand from the President himself his own desires in the field of economic and monetary policy.

Mr. MINISH. So that he can only get the views of the people that he is dealing with until he gets further directions from the Open Market Committee?

Secretary DILLON. Well, yes, as I pointed out in my prepared statement, he cannot commit the Open Market Committee or the Board to any specific action.

He can commit himself to trying to obtain action, if he wishes to, and at times I think that has been the case. But he cannot commit the Board.

Mr. MINISH. On another subject, Mr. Secretary, as I understand it, the Treasury maintains balances of an average of about \$4 billion in its banks.

This is what they had last year for which they received no interest—

The CHAIRMAN. I believe it was \$5.3 billion, was it not? Is that not right, Mr. Secretary?

Secretary DILLON. I think last year it was a little higher than it had been in the past.

It was about \$5.3 billion average. In the last 3 or 4 months, I think it has averaged about \$4 billion, or what it did in the past. But take \$5 billion, plus or minus a little.

Mr. MINISH. Well, why should we maintain this kind of a balance when we are out borrowing money to help run the Government?

Secretary DILLON. Well, the real problem is the rapid flow in and out of these accounts of taxes and other receipts which are collected not only periodically in time, but in great big lumps.

The bulk of the withholding taxes on personal incomes comes in four times a year—similarly, corporate payments four times a year, and nonwithheld personal taxes four times a year.

So certain months have substantial amounts coming in and others have practically nothing coming in, so you build up a big temporary balance. In 1 month it runs over and in the next month it does not, and that is what this average comes from.

There are times when tax and loan accounts get up as high as \$8 or \$9 billion. There are other times when they are down to \$1.5 or \$2 billion.

You have to look at this on a full Government basis—we spend \$4 billion every 2 weeks, more or less, and, therefore, the funds are flow-

ing rapidly. That is an average figure—there are some 2-week periods when we spend a lot more than this. We need an adequate backlog in these tax and loan accounts.

They were set up during World War I, and they have been developed since then.

They were set up precisely for the purpose of keeping the account of the Federal Government on which we write our checks—which is the account at the Federal Reserve—more or less stable, because that account directly affects reserves and the tightness or ease of credit.

And if you did not have that account reasonably steady you would have violent swings backward and forward between ease and extreme tightness of credit as these Government funds flowed in and out.

Mr. MINISH. Well, apparently you are concerned with it, because I see on page 11 that you have a study underway.

Secretary DILLON. Yes. The Treasury has made a number of these studies, and the ones in the past have shown that the services provided to the Government were worth as much as, or more than, the interest earnings of the banks on these deposits. That is irrespective of these other important benefits, which constitute the basic reasons for tax and loan accounts.

But we have not had a recent study and, since interest rates are somewhat higher now, there might be a change in this relationship. We agreed last fall, at the suggestion of Senator Douglas and the Senate Finance Committee, to make a new study which would not only bring the material or the earlier facts up to date, but which would be much more broadly based.

We are covering about twice as many banks in this, and we would expect to have all of this information in and coordinated and hope to have it in report form by the 1st of July, which is the date we said we would try to get it ready by.

Mr. MINISH. Did I understand you clearly or did you say that the previous studies have shown that it has cost more than the interest earned by the banks?

Secretary DILLON. The previous studies by the Treasury, the last one of which was in 1960, showed that the services were worth slightly more than the interest earned.

Mr. MINISH. Thank you. That is all, Mr. Chairman.

The CHAIRMAN. Yes, sir. Mr. Bolton?

Mr. BOLTON. Mr. Secretary, reverting to the subject of balance of payments, which Mr. Reuss raised and which I have a very real interest in, though I do not necessarily see eye to eye with him, since the declaration of the policy of the administration of the so-called equalization tax last year, has the Treasury made any record of how many American funds were frozen abroad and not brought back?

Secretary DILLON. We have no records, but I do not see any reason why any of them would be.

Mr. BOLTON. Because they would be invested in foreign funds abroad is the point that was made to me by some people who have contacted me.

Secretary DILLON. Oh, you mean if they wished to evade taxes?

Mr. BOLTON. If they wished to evade the equalization—

Secretary DILLON. If they wished to criminally evade the tax they can do that, but I think there are very few people who are deliberate criminals in this country.

Mr. BOLTON. How would they be criminals, sir, if the funds are in France now?

Secretary DILLON. That is what the law provides. It does not matter where the funds are.

If you have your own funds and they are American funds and you buy a foreign security, that purchase is subject to tax.

Mr. BOLTON. That is on future securities. That is correct?

Secretary DILLON. That is correct. There is a free market both abroad and in the United States. That is why it makes no difference.

There is a free market in foreign securities between Americans, and an American can buy from another American without tax. There are some \$12 billion worth of foreign securities owned by Americans. It is a very big market. But an American cannot buy from a foreigner without paying a tax irrespective of where his bank balance happens to be. So, therefore, this problem would not appear.

I think there is a misunderstanding because, while people can evade the tax by being abroad, it would be the same way as they evade the income tax. I do not think that is what you had in mind.

Mr. BOLTON. I did not. Mr. Secretary, what other controls does the Government have today outside of the suggested tax for the issuance or floating of borrowings of other countries in this country?

Secretary DILLON. We have none.

Mr. BOLTON. Having been in the investment business for many years, sir, would you suggest that a flotation would be made in this country if the Street knew that it was not favored by the Government?

Secretary DILLON. I think that that gets to this question of informal controls and they are a very difficult thing.

The problem is that it gives a very great degree of responsibility to the Government to choose between individual issues and, just by doing that, between individual investment bankers. If this were to be entirely voluntary, the problem that has occurred in the past, and I think would occur again, is that there would be, for a while, some inclination to observe the voluntary indications by the Government, but that sooner or later you would find some individual who would disregard that and then, for competitive reasons, the whole thing would be likely to break down.

So I think that the only alternative to this interest equalization tax to achieve the purpose which we felt was necessary—regretfully, because we do not like to have any rules in the area—would be a Capital Issues Committee with the formal right to approve or disapprove issues. That would be a much more direct form of capital control, with authority in the Treasury bureaucracy to make these decisions rather than, as is the case under the tax, allowing the market to make the decisions and simply raising the cost of issuing securities by foreigners to a point where we hope that it will diminish the outflow.

Mr. BOLTON. Well, actually, is that responsibility not put in the Treasury now, the same responsibility that you have just referred to, by the many exceptions in the tax?

Secretary DILLON. No, not at all. The only place where there is an authority in any way comparable would be in the case where imposition of the tax would threaten the stability of the international monetary system.

That applies, as we see it, only to Canada. In that case, because of the close interrelationships of our two markets and the close relationships between our interest rates, we said that we would intend to exercise that exemption for Canada.

On the obverse of that, the Canadians agreed to limit their drawings on our markets to what they need to maintain a balance in their payments and not to borrow here as they did in late 1962 and 1963, which had the effect of substantially increasing their international reserves.

And they are able to do that by operating on their own interest rate and the differential between it and the United States. The President has the right in the law if this does not work, and if Canadian borrowings are too high and are not reduced below the exorbitant levels that they reached in the first part of 1963 and late 1962, to set an overall limit for the year under which Canadian bonds could come in without paying the tax and beyond which they would be subject to the tax. So there is some element of control, but not on individual issues.

Mr. BOLTON. Do I understand the Secretary then to take the position that Japan would definitely not be brought under this provision?

Secretary DILLON. Our position, which we have taken both in committee and with the Japanese Government, is that we see no parallel there. There is no real need for Japan to have any exemption because their interest rates are very high in Japan and even with payment of the tax here they would still often be able to obtain money here at a lower rate than they can obtain it locally in Japan. So we think that they can and will be able to borrow here with the payment of the tax.

This will push them to try and borrow more in Europe, which would be a good thing. We think that there will be Japanese borrowing here, but it will not be in the tremendous volume that was indicated last year, nearly \$400 million had the tax not been proposed.

Mr. BOLTON. Thank you, Mr. Secretary.

Turning to another subject, you mentioned that you had a supplemental request in for the mint expenses. Was that included in the original budget request, the appropriations request?

Secretary DILLON. That supplemental for extra coins went up at the time of the budget in January. The one for making plans on the mint, that went up some time last November.

Mr. BOLTON. What I mean is, were those figures which are now in supplementals, originally requested by the Treasury for their 1964 appropriation?

Secretary DILLON. I do not think so. I think they gave us our full request in 1964, and then this coin shortage was even more acute than we had thought it would be, so we asked for extra funds.

Mr. BOLTON. Reverting now, if I may, to the subject before us, one of the questions that has come up in the hearings is whether or not minutes of the Open Market Committee should be made public and furnished to this committee.

I wonder if you would care to comment, sir, on whether or not this would be damaging, if the minutes were made public, either with regard to our relations with foreign countries or with regard to the disclosure of the information upon which the Fed made its decision

and, therefore, upon the business community particularly with respect to timing.

Secretary DILLON. Well, those are two really separable questions and my opinions are quite different on them.

Beginning in, I think, 1962 or about there, the Federal Reserve Board and the Open Market Committee began to have quite extensive discussions on foreign operations.

These were separable in the minutes because they would discuss domestic policy and then move to foreign. There was always a break. In discussing this, the Federal Reserve Bank of New York acts as agent for the Treasury in the operations of the exchange stabilization fund, and they also operate for their own account or they began to at that time.

I have looked through these minutes, and there are a lot of comments on negotiations, or the details with respect to negotiations, with foreigners—what our objectives are, and what we are trying to get and so on.

It is my view that it would be extremely damaging both from the point of view of our relations with other countries and from the point of view of our balance-of-payments position—stability of the dollar and so forth—to have the foreign side of these minutes given any publicity at all.

As far as the domestic side is concerned, I do not really have any strong opinion on that. I think that the Board does make its findings public. Whether they should make the details of the minutes more public or make them public also is a matter of timing. Obviously at some time I should think they would be made public and would become historic documents. It is more a question of time than anything else, and I think they are more competent to deal with this matter than I am. I certainly do not think they should be made public at a time of pending decisions on matters of immediate controversy, but I do not know how long that would be. It might not be very long.

Mr. BOLTON. Thank you, sir. My time has expired.

The CHAIRMAN. Yes, sir. Mr. Hanna?

Mr. HANNA. Thank you, Mr. Chairman.

Mr. Secretary, I noticed that you are sending out some questionnaires to banks relative to the cost of the services that they provide for the Government, and I think that is a very good idea.

I presume from that that you think it is important that we know what their assessment is and what their cost is?

Secretary DILLON. That is correct. Congress has been interested before in this matter, and the Treasury made a similar study in 1960, but this one is more complete. We asked for more complete information, and it goes to about twice as many banks. So it is a very much larger sample. It includes all of the large banks. The first 220 largest banks are included; the study also includes 380, I think it is, smaller banks chosen at random throughout the country. These are classified according to size, so we could get by means of a sample—not just an overall figure—of how it affects different size banks in different parts of the country. Thus, we should get a complete report.

Mr. HANNA. I would presume from that that you would also want to relate that information to the advantages that come to banks both from the deposits of Government money, on which we get no interest,

and the advantages that come to banks through the Federal Reserve System which are paid for out of the Treasury by the unique methods we use, through the securities that are bought by the Federal Reserve.

Is that not also true?

Secretary DILLON. Well, certainly part of the questionnaire, which is more detailed than earlier, goes to that because we can calculate the interest that they can obtain on these deposits because we know what the going rate of interest is on Treasury bills at any given time. In an earlier questionnaire we just asked for average deposits, but in this one we have asked for the average and the high and the low each month, so we can get a much more complete picture of how that average was arrived at.

I do not know about the great benefits to banks through the Federal Reserve System. I know many smaller banks seem to think it costs more to become members than it is worth to them. The reason for that is that when you are a member of the Federal Reserve System you are subject to its reserve requirements, whereas nonmember State banks are not.

Mr. HANNA. I believe that you are right in saying that the small banks have a different position because I think that in regard to your testimony about the advantages of the Government deposits, I think that the reports we recently got show that the small banks really lose money in terms of their expense over the handling of the deposits and the medium banks about break even, and it is really the large banks that get the advantage.

Is that not a correct assessment of the report?

Secretary DILLON. I think it is certainly correct that the large banks are better off in this area than the smaller banks, but they also, of course, have a different responsibility and liability because the largest banks are subject to having their tax and loan accounts drawn on without notice at all.

I mean, they can be notified 1 day and they will give up the money an hour later. They have to do it, whereas the smaller banks only are called at certain specified times and are given 3 days to a week, depending on the size of the bank, to meet the call.

Mr. HANNA. Do you make the results of that survey available or will you, to this committee?

Secretary DILLON. Oh, yes. This will be publicly available. It will be made available to this committee and any other interested committee.

Mr. HANNA. Could we also have some indication of how you have qualitatively analyzed the accuracy and so on of the report?

Secretary DILLON. Oh, yes, when we make it we will do that.

Mr. HANNA. Now, I noticed on page 6 of your statement that you say:

The day of private central banks operating without regard to Government policy is long since gone, and quite properly so.

Now, I find in that statement two separate, really, ingredients. The first ingredient relates to private central banks and the second relates to operating without regard to Government policy.

Now, looking at the two parts of this statement, I am wondering how you would characterize the Open Market Committee.

Is it private, in your estimation, or is it public and on what basis is it either or is it neither?

Secretary DILLON. Well, I think it is certainly a public institution. I do not think that the Federal Reserve—despite vestigial private elements—or the individual banks consider themselves private institutions.

I think that they look on themselves, and certainly we look on them and I think the Federal Reserve Board looks on them, as public institutions.

And so I think, since the heads of these institutions are on the Open Market Committee, that that is a public institution.

Mr. HANNA. There is some problem, however, because of vestigial characteristics flowing from the stockownership and, No. 2, do you not have a little trouble in relating it to our usual sense of a responsive organization within the framework of the Government?

In this sense, I mean, to whom is the Open Market really responsible in a direct sense in its actual operations?

Secretary DILLON. Well, I suppose it is responsible to the Congress, as is true for the whole Federal Reserve System.

Mr. HANNA. And that, under the general law, primarily as set up in the Federal Reserve?

Secretary DILLON. That is right.

Mr. HANNA. And looking at this question about the position of your agency's government and the Federal Reserve I noted with interest that your acceptance of the fact that there has been real good rapport or you do not see too much clash over policy. I can understand that.

I think that is to the good of the country. Let me ask you this: Besides Mr. Roosa, who is with you, how many other people in the direct echelons of under secretaries or assistants to under secretaries come to you directly from the Federal Reserve?

I notice that there is—

Secretary DILLON. I think we have, besides Mr. Roosa, one of other gentleman who is the Deputy Assistant Secretary for International Affairs. He came from the Federal Reserve Bank of New York, where he had developed considerable knowledge in dealing with foreign exchange and, as we had to move into that area and do more of that, we needed someone with that particular capability, and such a person is not easy to come by because we have not done too much as a country in this area except since 1958 or 1959.

We were very fortunate to be able to get his services for a time. So he has resigned from the Federal Reserve Bank of New York, where he had done that business. He is the only other man that I know of.

Mr. HANNA. I have been rather impressed by the ability of the Federal Reserve to be a seedbed for bright young men in the monetary policy field, which is utilized by many agencies of the Government.

Secretary DILLON. Well, I think that is true, and there have been many of them who move into commercial banking after they have been with the Federal Reserve.

Mr. HANNA. Well, thank you very much, Mr. Secretary. I see that my time has expired.

The CHAIRMAN. Mr. Brock?

Mr. BROCK. Mr. Secretary, in looking at the operations of the Open Market Committee, is it not true that there is a fairly direct cause-

and-effect relationship between our domestic monetary policies and our balance-of-payments policies?

Secretary DILLON. I think there is. It is true that the balance-of-payments problem has to be taken into account in setting our domestic monetary policy, yes.

Mr. BROCK. Well, I wanted to make that clear because I gathered from the way you put it that you thought there was a difference in the minutes of the Open Market Committee as they pertain to international transactions and domestic.

Secretary DILLON. Well, what I meant to say on that is that they have kept their minutes separate.

I do not mean to suggest the problem can be isolated. I would classify as part of domestic where they say for balance-of-payments reasons "we think we have to have tighter or looser," or whatever it is, reserves.

When I talk about the foreign part I am talking about actual operations, such as swap operations or things such as that, where we are actually operating in foreign currencies and negotiating and making deals with other foreign central banks, and there are, in those minutes, very frank statements of what the foreign central bankers may have said and things of that nature that just cannot be made public without breaking their confidence.

Mr. BROCK. Well, the point I am trying to get at is, that you do not differentiate though in the adverse effects which could come about in the international balance-of-payments problem in the release of the minutes relating to either the domestic or international problems.

Secretary DILLON. No, I think there is a different situation. I think the foreign part that I was talking about would be very serious.

I think the domestic side would indicate that there were balance-of-payments considerations. For instance, last summer such considerations led to the decision of the Board that it was necessary, to stem the flow of funds, to raise the discount rate. I do not see that that would have any serious international repercussions or problems for us.

That is merely a question of timing and it would be similar to other domestic matters. I think the question of timing is very important, but I think that is something that probably the Federal Reserve itself would have a better opinion on that I do.

All I can say is that I think it ought to be long enough so that the particular items are not the subject of current controversy—

Mr. WIDNALL. Will you yield for a question?

Mr. BROCK. Yes.

Mr. WIDNALL. Is there full consultation by the Open Market Committee with the Treasury in connection with swap operations?

Secretary DILLON. Oh, yes. You see, there is a slightly different relationship in that respect which has never been completely spelled out.

The Secretary of the Treasury, as chief financial officer of the Government, is specifically charged with specific responsibilities in oversea operations, and things of that nature.

So we have a somewhat different relationship with the Federal Reserve. They are more bound, and I think in the long run they are pretty well bound if a real question came up, to the views of the



Treasury, and to follow them in their oversea financial operations, which is not the case in setting monetary policy in the United States.

So, therefore, they work very closely with us.

Mr. WIDNALL. Thank you.

Mr. BROCK. Thank you.

The only point I was trying to raise is that there has been a great deal of criticism of the so-called secrecy of the operation of the Fed, and I think there is good reason for it. I think you will agree with that.

On a question raised previously on this limit of 4¼ percent on the yield of Government securities, if you had such a limit without an increase in the reserve requirements you would have, in my opinion, a tremendous inflationary pressure if inflation were in progress at the time. Is this correct?

Secretary DILLON. Yes; that is correct. That is what my comments were, more or less, addressed to here, because I think that is what the particular bill provided, but changing the reserve requirements, that is something, as I said, I would have to study—

Mr. BROCK. Of course, if we did change reserve requirements to try to curtail this inflationary pressure, we would in effect be freezing some of the earning assets of the banks?

Secretary DILLON. Oh, yes.

Mr. BROCK. Which I do not think is a healthy point of departure for controlling the monetary supply, anyway.

Can I ask you one question that is sort of on a nebulous point, but it was raised earlier about the differences between the Treasury and the Federal Reserve Board of Governors?

Is it really possible for you to have a violent disagreement? I mean, these are not black and white decisions in most cases.

Are they not mostly a gray area? You have a number of experts that disagree within the Treasury, as they do within the Fed?

Secretary DILLON. I think that is correct. I think it would be unusual to have—certainly in the spirit in which we have been working in the 3 years that I have been here I have not seen any—real black and white basic differences of opinion.

However, if you had strong-minded individuals on either side, even if it were gray area issue, they might strongly differ with each other. We have not had that sort of a situation in the last 3 years.

I think there have been some differences of opinion in the past. I think, there were some differences of opinion on a number of occasions—probably on one or two occasions during the preceding administration—that were quite strong, but after a time they evaporated.

Mr. BROCK. I gather then, in sum, you would say that the differences over the long run are relatively healthy rather than nonhealthy?

Secretary DILLON. Yes. As I said here, we should not be distressed if there are occasionally differences of opinion. It is a normal thing.

I do not think it would be normal if they are there all of the time. I do not think the System would work at all that way.

I think the monetary authority has to be in tune with the rest of the Government, but that does not mean that the views have to be exactly the same at every moment.

Mr. BROCK. And from reading your testimony and listening to you today I have gotten the impression, and correct me if I am wrong,

that you are opposed personally to these bills as they are presently written.

There is one bill that I did not hear you comment on, and that was H.R. 3783, which provides for retirement of the stock in the Federal Reserve held by member banks.

Do you have an opinion on that particular bill?

Secretary DILLON. That was the vestigial remnant that I was referring to. I think there are just two points about that that can be made.

One is, it is taken by some to be sort of a symbolic evidence of the independence of the Reserve System and to abolish it might somehow have a psychological effect on that.

I am not sure that there is a particular advantage to be gained by doing it. I think that the burden of proof should be on why you are going to get a benefit out of abolishing it, and just what that benefit would be.

I am told that there is a certain advantage for some of the smaller banks—particularly those which feel that Federal Reserve membership is burdensome—in the fact that they get a generous return of 6 percent on this as part of their earning assets. Most of their earnings assets nowadays yield a little less than that, although there are a good many loans made at 6 percent which would be similar, but this is a better return than they could get on Government securities or other types of securities, and they probably think that it is a pretty sound investment.

So, therefore, it is one of the things that will interest them in maintaining their membership.

But I do not think it can be very important because I looked at this overall figure and I find that their investment in the stock is about a quarter of 1 percent of their earning assets. It is a very small amount overall.

So I think that is the situation; it could go either way without any major effect.

Mr. BROCK. Thank you. I should like to add, in conclusion, that one of the proposals which you have endorsed, in order to provide the Federal Reserve with the ability to extend credit to member banks, was provided in a bill introduced by Mr. Kilburn last September.

Secretary DILLON. That is correct. We have not taken a position on the specific language in the bill, but we are in favor of its objectives.

Mr. BROCK. Thank you.

The CHAIRMAN. Mr. Dillon, I would like to summarize and ask you a few questions, and if there is anything that you desire to extend your comments on, you may do so after you look over your transcript.

Secretary DILLON. Thank you.

The CHAIRMAN. No. 1 is this phrase "independent within Government." My understanding is, from interrogating these people for a long time, that what they are really saying is "independent outside the Government." Their actions indicate that.

Now, if the Federal Reserve is truly independent within the Government, why, then the Constitution says that the President is the Chief Executive and if it is independent within the Government and there is a difference of opinion between you and Mr. Martin it would go to the President for decision; would it not?

Secretary DILLON. If it is within the executive branch, but in our Government we have certain things that have grown up that are appendages of the Congress that act a little differently, and I think the Federal Reserve have thought of themselves certainly more an instrument of the Congress than of the Executive.

Whether that is correct or not is quite a difficult and abstruse question.

The CHAIRMAN. I do not think it is difficult. The law is the law. The Constitution is very plain on it, that Congress passes the laws. The executive executes the laws. Is that not very plain?

Secretary DILLON. Well, no. Take the General Accounting Office, the Comptroller General—certainly no one has thought that he—

The CHAIRMAN. Well, now, you are on a different subject, Mr. Dillon. You may comment on that in the transcript, if you wish.

Now about your meeting these fellows at lunch and, of course, discussing all of these things, it occurs to me this arrangement is just a good buddy-buddy agreement to discuss these things but with no power to act.

If you told Mr. Martin that, "Now, the President feels very strongly about this. He thinks you are going too far on this restraint. You are doing things that will minimize the benefits of the tax bill, for instance. We want you to change. We want you to loosen up."

Under the present arrangement Mr. Martin would not have to tell you a thing, would he?

Secretary DILLON. I think that under the present arrangement—the way it works—he would take that sort of advice very seriously, and it would deeply influence any decision he might reach as to his own position and as to his advice to his committee.

I do not know that it would make him finally, in every case, be responsive to that.

The CHAIRMAN. In other words, he would say, "I will consider it."

Now, every 3 weeks the Open Market Committee meets in secrecy. You have stated here, and I took it down, that public servants should administer our monetary policies—that was the way I understood it—people who are selected by the President; is that right?

Secretary DILLON. I do not know that they have to be selected by the President. They should be public servants.

The CHAIRMAN. All right. Now, then the Open Market Committee is composed of 7 so-called public servants and the 12 Reserve bank presidents, who do not even take an oath as presidents of the Federal Reserve banks—

Mr. BROCK. Will the gentleman yield?

The CHAIRMAN (continuing). And the directors who elect them and whom they represent also do not take any oath to support the Constitution of the United States like public officials.

They just take an oath that they will not discriminate between banks. Did you know that, Mr. Dillon?

Secretary DILLON. I became aware of that when I saw some testimony on the results of the hearings yesterday.

I think you mentioned it then, Mr. Chairman. I do not know the reason they do not take an oath. I do not see why they should not.

I think it would be preferable.

The CHAIRMAN. Well, they do not consider themselves part of the Government. They want to be outside of the Government.

Now, they do take an oath when they become members of the Open Market Committee, but remember this, only five of them there are officially members of the Open Market Committee. The other seven are participating but they are not under oath.

They are under no kind of an oath to support the public interest. They are selected by the banking interests and, naturally, you would think they would represent the banking interests.

Now, concerning the audit, why would it not be better for the Federal Reserve to just pay the GAO, the General Accounting Office, for conducting an audit?

Would not that be better than having a self-audit, Mr. Dillon?

You see, the Reserve banks are in this position: For 50 years they have handled hundred of billions of dollars of public money, actual money, actual greenbacks that were used, and no one was looking over their shoulder from the outside, no one. They had no GAO audit, no independent audit, only an audit of their own, a self-audit.

Do you not think that ought to be changed?

Secretary DILLON. Well, I had not understood it quite that way, Mr. Chairman—

The CHAIRMAN. Well, that is the way it is.

Secretary DILLON (continuing). I understood that the Board had an outside independent auditor come in and audit their accounts every year.

The CHAIRMAN. According to their wishes; yes, sir; according to their wishes.

They laid down the rules and an audit under such rules isn't an independent audit.

Now, with respect to the tax and loan accounts; it occurs to me, as much trouble as the banks are making—they claim they are subsidizing the Treasury—

Secretary DILLON. Yes.

The CHAIRMAN (continuing). And losing money.

It occurs to me that they are spending a lot of money of their own and going to a lot of trouble and making a lot of speeches for the privilege of continuing to lose money.

Do you not think that you could solve their problems and relieve their aches and pains by abolishing the tax and loan accounts? Then the money would go right into the Treasury. It would be paid on the national debt, and if we had used it that way last year, \$5.4 billion on the average, the taxpayers would have gotten over \$200 million benefit from it. Do you not think that is a much better way to have this handled?

Secretary DILLON. No, sir; I do not, because tax and loan accounts enable us to prevent very violent changes—

The CHAIRMAN. All right, wait a minute. You have said that before—

Secretary DILLON. That is right.

The CHAIRMAN (continuing). And I want to answer that particular one. I know the other one, too.

What is the Federal Reserve for? That is why it was established, to make the flow of money and credit easy throughout the Nation.

That was one of the arguments for it. Now then, they can do that and if you take that power away from them what is left for the Federal Reserve?

They are doing practically nothing now except for the Federal Reserve bank in New York. In fact, I have here a list of the floor space of the buildings here in Washington and in the Federal Reserve banks. This includes the Federal Trade Commission, National Archives, the Department of Justice, Internal Revenue, the Post Office Department, Interstate Commerce, Department of Labor, Department of Commerce, and they all have about 4.7 million square feet.

Now, the Federal Reserve has 4.6 million square feet, just about the same.

There are 22,000 employees in the first category and 19,700 in the other.

At this point I will insert this comparison in the record.

(The comparison referred to follows:)

A comparison of usable space reported by the 12 district Federal Reserve Banks and the net space in U.S. Government buildings in the Federal triangle in Washington, D.C., as reported by the General Services Administration, shows that the Government has about 14 percent more employees in about 3½ percent more space.

Building	Net square feet	Personnel
Federal Trade Commission.....	166, 392	875
National Archives.....	855, 805	525
Department of Justice.....	610, 320	4, 302
Internal Revenue Service.....	758, 385	4, 012
Post Office Department (2).....	722, 031	3, 888
Interstate Commerce Commission.....	288, 400	1, 556
Department of Labor.....	282, 695	1, 873
Department of Commerce.....	1, 083, 360	5, 481
Total.....	4, 767, 388	22, 512
Federal Reserve banks.....	4, 605, 612	19, 747

The CHAIRMAN. Now, then, if you are going to take away one of the fundamental reasons for the adoption of the Federal Reserve System, one of the main reasons—well, what is left for the Federal Reserve to do?

They have practically closed the discount windows. They do not earn their salt on the business they now do. They get all of their money from the Open Market Committee, from the earnings on the Government bonds that they bought without cost to them, not one penny of cost.

So what are you going to leave the Federal Reserve System to do, if you continue to take this function away from them which you are doing through the tax and loan account according to your own testimony. What do you say to that, Mr. Dillon?

Secretary DILLON. I think we are simplifying their task. They still have the task of regulating the supply of money, which they do. The problem on the tax and loan account is, as I pointed out—there are times when those payments, particularly on taxes, are very heavy, as much as \$10 billion in a week or so.

The CHAIRMAN. We just talked about that. That is what we are talking about.

Secretary DILLON. That is what I am trying to talk about, Mr. Chairman.

The CHAIRMAN. I say that you are—

Mr. WIDNALL. Mr. Chairman, can he not even finish his statement?

The CHAIRMAN. He said it.

Secretary DILLON. No; I have not finished it, but I will be glad to submit it in writing, if you prefer, Mr. Chairman.

The CHAIRMAN. Well, that is all right, you said it in your statement, too, but I do not want to cut you off, Mr. Dillon, I would not do that.

Mr. WIDNALL. Let him give the rest of his statement.

The CHAIRMAN. That is what I am saying right now.

When I say "I do not want to cut you off" what does that mean? Go ahead.

Secretary DILLON. All I wanted to say, Mr. Chairman—I appreciate your courtesy very much—was with \$10 billion coming in in a very short period, if the Federal Reserve had to make offsetting transactions to keep the credit level at that volume, in that period of time, it would be extremely disturbing to our markets, and that is why the tax and loan accounts avoid the necessity for doing this.

I realize this is a highly technical subject, and I would be glad, in view of your interest in it, to comment on it, and I will avail myself of the privilege which you so kindly gave me at the beginning, to comment on it further in writing afterwards.

The CHAIRMAN. Yes, sir.

(The following statement was supplied for the record:)

The special advantage of the tax and loan account system is that funds received in taxes or as a result of borrowing in excess of immediate requirements can be retained in the commercial banking system until the Treasury needs them for current expenditures, at which point they are promptly returned to the banking system via those receiving Government payments. The procedure thus avoids a whipsawing of bank reserves and deposits from day to day as Treasury receipts and expenditures vary widely over short periods of time. Without some procedure for smoothing this impact, money market conditions would gyrate widely, and the orderly distribution of bank credit would be impeded. Neutralizing the impact of Treasury operations on the market thus facilitates the efforts of the Federal Reserve to carry out its broader responsibilities for influencing the aggregate supply of bank credit and the tightness or ease of credit markets generally in accordance with changes in underlying economic conditions by removing from the market a source of temporary instability.

If the Treasury did not have an effective procedure for smoothing the impact of its own operations on the banking system and the money market, the Federal Reserve would itself have to try to counteract the effects of Treasury operations. This would mean essentially that the Federal Reserve would have to buy large amounts of Treasury bills whenever net Treasury receipts were taking reserves out of the banking system, and would have to sell equally large amounts when the Treasury, by net expenditures, was putting funds back into the banking system. These purchases or sales would be almost a daily necessity, and there would be a serious question as to the capacity of the market to handle this volume of activity without severe repercussions on prices and yields.

For example, at times the Treasury, in the absence of the tax and loan account system, would absorb as much as \$5 billion of reserves from the banking system in the space of a week or two. To offset this reserve impact, the Federal Reserve would have to buy an equivalent amount of Treasury bills in the same period, only to sell them again shortly thereafter as the Treasury position reversed itself. This volume of purchases—running to some 10 percent of the total volume of Treasury bills—far exceeds the normal supply available in the market over so short a period, while the sales would similarly exceed the capacity of the market to absorb them. Operations in this size converging on the bill market, exceeding the normal volume of Federal Reserve transactions

by many times, would clearly not be conducive to orderly money market conditions and an effective market mechanism.

Moreover, the size of Treasury receipts from day to day cannot be estimated precisely. Estimating errors are of relatively little consequence when the funds will, in any event, remain lodged with the commercial banks until needed. But without tax and loan accounts, the offsetting Federal Reserve action, necessarily based upon the estimates, would frequently leave the banking system with either more or less reserves than intended, depending upon whether Treasury receipts were smaller or larger than estimated.

Finally, it should be noted that the tax and loan account procedure leaves the tax and other receipts in the same banks and the same communities about the country in which the payments are made by taxpayers or by those purchasing Treasury securities, to be withdrawn only as needed by an orderly call schedule. Thus, the tax and loan account system not only avoids a wrenching effect on the central money market, but also unnecessary and disturbing sudden flows of funds between banks and areas of the countries. There is no other device available to either the Treasury or the Federal Reserve that would achieve similar results. The Federal Reserve, in particular, can potentially supply an aggregate amount of funds to the money market equivalent to the net loss of reserves stemming from Treasury operations, but it cannot direct those funds to the particular banks from which the deposits are shifted.

The tax and loan account procedure thus is an effective way in which the Treasury can prevent its own operations from unnecessarily disturbing financial markets and free the Federal Reserve to carry out its responsibilities in the most suitable way.

The CHAIRMAN. The Federal Reserve, if it had any duty at all, it is to make the flow of funds, money and credit, smooth throughout the Nation.

Throughout the history of the System that has been the main reason for its existence and now then here you are trying to take it away from them. You ought not to get into their business. That is their business.

Now, if you will leave this as it was, abolish these tax and loan accounts, and bring this money in and apply it immediately, you would save the taxpayers \$200 or \$300 million a year, and it occurs to me that is a fair amount for your consideration, and I hope you will consider it.

Now, in determining the value of the services rendered by the banks, do you take into consideration the cost to the Government and the value to the banks of the check clearing privileges?

Do you take that into consideration, Mr. Dillon?

Secretary DILLON. Well, that is a difficult question—

The CHAIRMAN. Well, why is it difficult? We pay it. We pay about \$125 billion a year for that privilege. The Government pays it.

Secretary DILLON. That goes through the Federal Reserve System and it is probably part of the benefit of belonging to the Federal Reserve System, the expenses of which are paid out of the reserves which the banks are required to hold there.

I do not think it has an application to tax and loan accounts.

Anyway, it is very difficult to determine it by individual banks because—

The CHAIRMAN. Well now, you did not do it, Mr. Dillon. We are going to have a lot to say about it over here when your report comes in—

Secretary DILLON. That is right.

The CHAIRMAN (continuing). Because if you are going to give banks credit for every little old item that they apply for, like cashing checks and things like that, to benefit other people and concerns and corporations for nothing—if we are going to have to pay them for

little things like that then they ought to have to pay for the cost of clearing their checks, as contemplated by the act now in the law in section 16—

Mr. BOLTON. Mr. Chairman, would you yield for a question?

The CHAIRMAN. Yes, sir.

Mr. BOLTON. Would you require the banks to use the Government clearinghouse or set up their own?

The CHAIRMAN. Set up their own, and I have a feeling maybe that we ought to consider that. Let the banks set up their own. They could probably do this for half as much as it is costing the Government, and I would be willing for them to do it, and I would be willing for the Government to pay for it for a while to see how they go about it.

Secretary DILLON. Only a few of the banks use the Federal Reserve clearing system. Most of the smaller banks clear through their correspondents.

The CHAIRMAN. That is right; they get the benefit of the system without paying for it.

Secretary DILLON. That is right.

The CHAIRMAN. What about the State banks, like Chase Manhattan in New York, that do not belong? How do they do it?

Secretary DILLON. They belong to the Federal Reserve System.

The CHAIRMAN. Isn't there one large bank there that—

Secretary DILLON. I think the Empire Trust Co. does not.

The CHAIRMAN. What about the Commercial Bank of North America?

Secretary DILLON. I would agree.

The CHAIRMAN. Well, anyway, State banks up there get their checks cleared through the Fed by having a correspondent, do they not?

Secretary DILLON. That is correct.

The CHAIRMAN. That is the natural way to do it over the country.

Secretary DILLON. That is right.

The CHAIRMAN. Now, on the short-term rates, Mr. Dillon, when did the Fed and the Treasury decide that it was in the interest of the country for you to see that the short-term rates were increased?

Secretary DILLON. Well, we came to that conclusion very early in 1961 when we saw the balance-of-payments problem. We felt that it was necessary to support our short-term rates and not let them fall to the extremely low levels that they had in past periods of easy money. At that time we indicated that we thought it would be possible to do that—indeed to strengthen and to increase the short-term interest rate—without having any noticeable effect on long-term rates. Many thought that was impossible—that if short-term rates went up long-term rates had to go up with them.

The record of the past 3 years shows that we achieved our aim, with a 90-day bill rate moving up from about 2.25 percent to about 3½ percent, while at the same time long-term rates for corporate bonds and municipal bonds are relatively unchanged, and average mortgage rates have declined by a half of 1 percent.

Of course, that is the most important of the long-term rates. So we think we have been successful there in achieving a balance-of-payments



objective and at the same time keeping low-interest rates in the areas that are important for—

The CHAIRMAN. It emphasizes the point though that you do not want any ceiling on rates but you want a floor?

Secretary DILLON. Not necessarily a specific floor because it will vary from time to time, depending on the conditions that one might find—

The CHAIRMAN. Yes, sir. I want to make this statement though for the record.

Receipts of the U.S. Government exceed \$100 billion per year. The greatest part of these receipts is from taxes. There are, of course, other sources of cash receipts like the postal system, and sales of securities.

I understand that generally these receipts flow from the taxpayers to the Treasury through the privately owned commercial banking system and thence to the Federal Reserve banks and finally to the U.S. Treasury. On its way to the Treasury, these funds are allowed to rest by the Treasury in the commercial banks for varying periods of time. The amount of these funds on deposit during 1963, and on which the banks could, and I am sure do, earn millions upon millions of dollars, always exceeded \$2,5 billion, and probably exceeded \$10 billion for some periods of time.

The bankers and the Treasury Department would have us believe that they are providing many services to the Government, for which they are not paid, and that the free use of these Government deposits only reduces their loss. I would like to stop these banks from losing money, not the 50 biggest banks in the country, but the thousands of small banks throughout the country which may be suffering a loss.

As for the big New York banks like the Chase Manhattan, the Morgan Guarantee, the Manufacturers Hanover Trust, and the First National City and the Marine Midland banks, I doubt that even the Secretary of the Treasury, whether he be George M. Humphrey, or Robert B. Anderson, or C. Douglas Dillon, will claim that they are losing money on Government business.

The analysis of Government deposits made by this committee last year shows where the big deposits are, not in the small banks, but in the big ones. Studies made by the General Accounting Office show that the big banks are surely profiting while the small ones may be losing. And if the small ones are really losing, they should be writing to their Representatives to support my bill to stop their losses.

Mr. Widnall has called my attention to the fact that it is after 12, and we have to report a bill on the floor.

I personally would like to ask some more questions and, Mr. Kilburn, would you like to ask some questions?

Mr. KILBURN. I would like to have about a minute.

The CHAIRMAN. All right, we will ask Mr. Dillon if he can come back Friday afternoon—

Mr. KILBURN. No; not for me. You won't give me a minute this morning?

The CHAIRMAN. Yes; I will give you a minute on anything that is material to the inquiry.

Mr. KILBURN. Well give it to me.

I would like to ask you what Mr. Vanik asked you, and that is, what is the administration's position on these bills? Do you have to have a request from the chairman for the—

Secretary DILLON. I think usually that is when the administration tries to develop a position and we have not had that formal request.

Mr. KILBURN. Well, Mr. Chairman, I formally request that you ask for the administration's position.

The CHAIRMAN. Well, that has been given consideration by the chairman.

Mr. KILBURN. That is all.

The CHAIRMAN. We will do that when we can develop the hearings so that they can intelligently develop an answer.

You cannot make an intelligent answer now, Mr. Dillon, can you, until you know what the hearings develop?

Mr. BOLTON. Mr. Chairman, what is the formal procedure for the—

The CHAIRMAN. Without objection we will adjourn until Monday at 10 o'clock.

(Whereupon, at 12:10 p.m., the committee was adjourned, to reconvene at 10 a.m. Monday, March 9, 1964.)

(The following letter and answers to questions submitted by Mr. Patman have been received and without objection are inserted at this point in the record:)

THE SECRETARY OF THE TREASURY,  
*Washington, March 17, 1964.*

HON. WRIGHT PATMAN,  
*House of Representatives,*  
*Washington, D.C.*

DEAR MR. CHAIRMAN: I am pleased to supply the answers to the questions in your letter of March 6. I trust that the replies fully cover the points which you wanted clarified.

Sincerely yours,

DOUGLAS DILLON.

Enclosure.

1. Please give us a complete list of the different issues of Government securities now outstanding, along with subtotals by type of security.

Attached is a listing of all securities comprising the Federal debt as of February 29, 1964, including the total amount outstanding in each class.

TABLE X.—Statement of the public debt, February 29, 1964

[On basis of daily Treasury Statements]

Title of Loan and State of Interest	Date of Issue	Redeemable (see footnote 1)	Payable	Interest Payable	Amount Issued	Amount Retired	Amount Out- standing
<b>INTEREST-BEARING DEBT *</b>							
<b>Public Issues:</b>							
<b>Marketable Obligations:</b>							
<b>Treasury Bills (Maturity Value): †</b>							
<b>Series maturing and approximate yield to maturity:</b>							
Mar. 5, 1964	3.487% 3.532%	9/5/63 12/5/63	}3/5/64	Mar. 5, 1964	\$801,671,000.00 1,300,546,000.00		††\$2,102,217,000.00
Mar. 12, 1964	3.460% 3.501%	9/12/63 12/12/63					
Mar. 19, 1964	3.522% 3.537%	9/19/63 12/19/63	}3/19/64	Mar. 19, 1964	800,730,000.00 1,301,337,000.00	††2,102,067,000.00	
Mar. 23, 1964	(Tax anticipation series) 3.537% <sup>39</sup>	10/15/63					}3/23/64
Mar. 26, 1964	3.507% 3.522%	9/26/63 12/26/63	}3/26/64	Mar. 26, 1964	799,927,000.00 1,309,053,000.00	††2,108,980,000.00	
Apr. 2, 1964	3.515% 3.524%	10/3/63 1/2/64					}4/2/64
Apr. 9, 1964	3.569% 3.534%	10/10/63 1/9/64	}4/9/64	Apr. 9, 1964	800,296,000.00 1,300,845,000.00	††2,101,141,000.00	
Apr. 15, 1964	3.062% 3.568%	4/15/63 10/17/63					}4/15/64
Apr. 16, 1964	3.549% 3.620%	1/16/64 10/24/63	}4/16/64	Apr. 16, 1964	1,301,055,000.00 799,739,000.00	2,101,410,000.00	
Apr. 23, 1964	3.538% 3.586%	1/23/64 10/31/63					}4/23/64
Apr. 30, 1964	3.501% 3.621%	1/30/64 11/7/63	}4/30/64	Apr. 30, 1964	1,300,475,000.00 799,976,000.00	2,100,788,000.00	
May 7, 1964	3.505% 3.678%	2/6/64 11/14/63					}5/7/64
May 14, 1964	3.540% 3.660%	2/13/64 11/21/63	}5/14/64	May 14, 1964	1,302,577,000.00 800,300,000.00	2,103,208,000.00	
May 21, 1964	3.534% 3.630%	2/20/64 11/29/63					}5/21/64
May 28, 1964	3.547% 3.670%	2/27/64 12/5/63	}5/28/64	May 28, 1964	1,201,700,000.00 799,967,000.00	2,003,379,000.00	
June 4, 1964	3.662% 3.679%	12/5/63 12/12/63					}6/4/64
June 11, 1964	3.650% <sup>41</sup>	12/19/63	}6/11/64	June 11, 1964	800,163,000.00	800,981,000.00	
June 18, 1964		1/15/64					}6/18/64
June 22, 1964	(Tax anticipation series) 3.650% <sup>41</sup>		}6/22/64	June 22, 1964		2,500,812,000.00	

June 25, 1964	3.657%	12/26/63	6/25/64	June 25, 1964	804,309,000.00		804,309,000.00			
July 2, 1964	3.651%	1/2/64	7/2/64	July 2, 1964	800,466,000.00		800,466,000.00			
July 9, 1964	3.669%	1/9/64	7/9/64	July 9, 1964	800,403,000.00		800,403,000.00			
July 15, 1964	3.582%	7/15/63	7/15/64	July 15, 1964	1,997,942,000.00		1,997,942,000.00			
July 16, 1964	3.679%	1/16/64	7/16/64	July 16, 1964	800,444,000.00		800,444,000.00			
July 23, 1964	3.648%	1/23/64	7/23/64	July 23, 1964	800,615,000.00		800,615,000.00			
July 30, 1964	3.613%	1/30/64	7/30/64	July 30, 1964	800,267,000.00		800,267,000.00			
Aug. 6, 1964	3.615%	2/6/64	8/6/64	Aug. 6, 1964	900,431,000.00		900,431,000.00			
Aug. 13, 1964	3.660%	2/13/64	8/13/64	Aug. 13, 1964	900,881,000.00		900,881,000.00			
Aug. 20, 1964	3.679%	2/20/64	8/20/64	Aug. 20, 1964	900,955,000.00		900,955,000.00			
Aug. 27, 1964	3.703%	2/27/64	8/27/64	Aug. 27, 1964	901,802,000.00		901,802,000.00			
Aug. 31, 1964	3.575%	9/3/63	8/31/64	8/31/64	1,001,143,000.00		1,001,143,000.00			
Sept. 30, 1964	3.586%	10/1/63	9/30/64	Sept. 30, 1964	1,001,960,000.00		1,001,960,000.00			
Oct. 31, 1964	3.633%	11/4/63	10/31/64	Oct. 31, 1964	1,000,273,000.00		1,000,273,000.00			
Nov. 30, 1964	3.590%	12/3/63	11/30/64	Nov. 30, 1964	1,004,801,000.00		1,004,801,000.00			
Dec. 31, 1964	3.707%	1/3/64	12/31/64	Dec. 31, 1964	1,000,309,000.00		1,000,309,000.00			
Jan. 31, 1965	3.680%	2/6/64	1/31/65	Jan. 31, 1965	1,000,393,000.00		1,000,393,000.00			
Mar. 5, 1964-Apr. 9, 1964	3.601%	10/28/63	(t)	(t)	600,552,000.00		600,552,000.00			
Total Treasury bills					53,549,831,000.00		53,549,831,000.00			
Certificates of Indebtedness: <sup>b</sup>										
3¼% B-1964					5/15/63	5/15/64	May 15-Nov. 15	5,693,160,000.00	\$1,494,914,000.00	4,198,246,000.00
Treasury Notes: <sup>b</sup>										
4¾% A-1964 (Effective Rate 4.7596%) <sup>3</sup>					7/20/59	5/15/64	May 15-Nov. 15	4,932,995,000.00	533,295,000.00	4,399,700,000.00
5% B-1964					10/15/59	8/15/64	Feb. 15-Aug. 15	2,315,724,000.00	270,460,000.00	2,045,264,000.00
4¾% C-1964 (Effective Rate 4.9347%) <sup>3</sup>					2/15/60	11/15/64	May 15-Nov. 15	4,195,320,000.00	327,562,000.00	3,867,758,000.00
3¾% D-1964					6/23/60	5/15/64	do	3,893,341,000.00	1,877,252,000.00	2,016,089,000.00
3¾% E-1964					8/1/61	8/15/64	Feb. 15-Aug. 15	5,018,652,000.00	933,305,000.00	4,085,347,000.00
3¾% F-1964					8/15/63	11/15/64	May 15-Nov. 15	6,398,134,000.00	435,516,000.00	5,962,618,000.00
4½% A-1965					5/15/60	5/15/65	May 15-Nov. 15	2,112,741,000.00	296,977,000.00	1,815,764,000.00
3½% B-1965					11/15/62	11/15/65	do	3,285,508,000.00	331,704,000.00	2,953,804,000.00
3¾% C-1965					11/15/63	5/15/65	do	7,976,816,000.00		7,976,816,000.00
3¾% D-1965 (Effective Rate 3.9620%) <sup>3</sup>					2/15/64	8/13/65	Feb. 15-Aug. 15	6,202,030,000.00		6,202,030,000.00
4 A-1966					2/15/62	8/15/66	Feb. 15-Aug. 15	6,264,784,000.00	444,818,000.00	5,819,966,000.00
3½% B-1965 (Effective Rate 3.6492%) <sup>3</sup>					5/15/62	2/15/66	do	6,386,537,000.00	733,795,000.00	5,652,739,000.00
3¾% A-1967 (Effective Rate 3.8210%) <sup>1,3</sup>					9/15/62	8/15/67	do	5,281,528,000.00	848,314,000.00	4,433,214,000.00
3½% B-1967 (Effective Rate 3.6726%) <sup>1,3</sup>					3/15/63	2/15/67	do	4,286,535,000.00	811,690,000.00	3,474,845,000.00
1½% EA-1964					4/1/59	4/1/64	Apr. 1-Oct. 1	456,514,000.00		456,514,000.00
1¼% EO-1964					10/1/59	10/1/64	do	489,777,000.00		489,777,000.00
1¼% EA-1965					4/1/60	4/1/65	do	465,673,000.00		465,673,000.00
1¼% EO-1965					10/1/60	10/1/65	do	315,094,000.00		315,094,000.00
1½% EA-1966					4/1/61	4/1/66	do	674,981,000.00		674,981,000.00

See footnotes at end of table.

TABLE X.—Statement of the public debt, February 29, 1964—Continued

[On basis of daily Treasury Statements]

Title of Loan and State of Interest	Date of Issue	Redeemable (see footnote 1)	Payable	Interest Payable	Amount Issued	Amount Retired	Amount Out- standing
<b>INTEREST-BEARING DEBT<sup>3</sup>—continued</b>							
<b>Public Issues—Continued</b>							
<b>Marketable Obligations—Con.</b>							
<b>Treasury Bills etc.—Con.</b>							
<b>Treasury notes—Con.</b>							
1½% EO-1966	10/1/61		10/1/61	Apr. 1–Oct. 1	\$356,530,000.00		\$356,530,000.00
1½% EA-1967	4/1/62		4/1/67	do	270,496,000.00		270,496,000.00
1½% EO-1967	10/1/62		10/1/67	do	457,177,000.00		457,177,000.00
1½% EA-1968	4/1/63		4/1/68	do	212,127,000.00		212,127,000.00
1½% EO-1968	10/1/63		10/1/68	do	52,303,000.00		52,303,000.00
<b>Total Treasury notes</b>					<b>72,301,347,000.00</b>	<b>\$7,844,689,000.00</b>	<b>64,456,658,000.00</b>
<b>Treasury Bonds:<sup>4</sup> b</b>							
2½% 1962-67	5/5/42	12/15/64 <sup>5</sup>	6/15/67	June 15–Dec. 15	2,118,164,500.00	657,644,900.00	1,460,519,600.00
2½% 1963-68	12/1/42	12/15/64 <sup>5</sup>	12/15/68	do	2,830,914,000.00	1,016,987,500.00	1,813,926,500.00
2½% 1964-69 (Apr. 15, 1943)	4/15/43	12/15/64 <sup>5</sup>	6/15/69	do	3,761,904,000.00	1,132,854,000.00	2,629,050,000.00
2½% 1964-69 (Sept. 15, 1943)	9/15/43	12/15/64 <sup>5</sup>	12/15/69	do	3,838,198,000.00	1,297,549,500.00	2,540,648,500.00
2½% 1965	6/15/58		2/15/65	Feb. 15–Aug. 15	7,387,534,000.00	3,413,013,000.00	3,974,521,000.00
2½% 1965-70	2/1/44	3/15/65 <sup>5</sup>	3/15/70	Mar. 15–Sept. 15	5,197,394,500.00	2,780,006,500.00	2,417,388,000.00
2½% 1966-71	12/1/44	3/15/66 <sup>5</sup>	3/15/71	do	3,480,865,000.00	2,074,808,500.00	1,406,056,500.00
3¾% 1966 (Effective Rate 3.7904%) <sup>3</sup>	11/15/60		5/15/66	May 15–Nov. 15	3,597,473,500.00	735,451,000.00	2,862,022,500.00
3% 1966	2/28/58		8/15/66	Feb. 15–Aug. 15	1,484,298,000.00	459,895,500.00	2,024,402,500.00
3¾% 1966	3/15/61		11/15/66	May 15–Nov. 15	2,437,629,500.00	586,221,500.00	1,851,408,000.00
2½% 1967-72 (June 1, 1945)	6/1/45	6/15/67 <sup>5</sup>	6/15/72	June 15–Dec. 15	7,967,261,000.00	6,660,693,500.00	1,306,567,500.00
2½% 1967-72 (Oct. 20, 1941)	10/20/41	9/15/67	9/15/72	Mar. 15–Sept. 15	2,716,045,150.00	764,237,900.00	1,951,807,250.00
3½% 1967 (Effective Rate 3.6083%) <sup>1,3</sup>	3/15/61		11/15/67	May 15–Nov. 15	3,603,544,500.00		3,603,544,500.00
2½% 1967-72 (Nov. 15, 1945)	11/15/45	12/15/67 <sup>5</sup>	12/15/72	June 15–Dec. 15	11,688,868,500.00	8,936,316,500.00	2,752,552,000.00
3¾% 1968 (June 23, 1960) (Effective Rate 3.9187%) <sup>3</sup>	6/23/60		5/15/68	May 15–Nov. 15	2,459,935,500.00		2,459,935,500.00
3¾% 1968	4/18/62		8/15/68	Feb. 15–Aug. 15	3,747,358,500.00		3,747,358,500.00
3¾% 1968 (Sept. 15, 1963) (Effective Rate 4.070%) <sup>1,3</sup>	9/15/63		11/15/68	May 15–Nov. 15	1,591,434,000.00		1,591,434,000.00
4% 1969 (Aug. 15, 1962)	8/15/62		2/15/69	Feb. 15–Aug. 15	1,843,615,500.00		1,843,615,500.00
4% 1969 (Oct. 1, 1957) (Effective Rate 4.0128%) <sup>3</sup>	10/1/57	( <sup>6</sup> )	10/1/69	Apr. 1–Oct. 1	2,534,426,500.00	978,500.00	2,537,448,000.00
4% 1970 (Effective Rate 4.0772%) <sup>1,3</sup>	6/20/63		8/15/70	Feb. 15–Aug. 15	4,129,240,000.00		4,129,240,000.00
4% 1971 (Effective Rate	3/1/62		8/15/71	do	2,805,626,500.00		2,805,626,500.00

3.8490%. <sup>1,3</sup>								
3 7/8% 1971 (Effective Rate 3.9713%). <sup>1,3</sup>	5/15/62		11/15/71	May 15-Nov. 15	2,760,420,000.00		2,760,420,000.00	
4% 1972 (Nov. 15, 1962)	11/15/62		2/15/72	Feb. 15-Aug. 15	2,343,511,000.00		2,343,511,000.00	
4% 1972 (Sept. 15, 1962) (Effective Rate 4.0840%). <sup>1,3</sup>	9/15/62		8/15/72	do	2,578,547,000.00		2,578,547,000.00	
4% 1973 (Effective Rate 4.1491%). <sup>1,3</sup>	9/15/63		8/15/73	do	3,893,834,000.00		3,893,834,000.00	
3 7/8% 1974 (Effective Rate 3.9516%). <sup>1,3</sup>	12/2/57	(9)	11/15/74	May 15-Nov. 15	2,244,772,000.00	695,500.00	2,244,076,500.00	
4 1/4% 1975-85 (Effective Rate 4.2622%). <sup>1,3</sup>	4/5/60	5/15/75 <sup>4</sup>	5/15/85	do	1,217,610,500.00	7,000.00	1,217,603,500.00	
3 1/4% 1978-83	5/1/53	6/15/78 <sup>4</sup>	6/15/83	June 15-Dec. 15	1,606,084,000.00	17,764,500.00	1,588,319,500.00	
4% 1980 (Effective Rate 4.0454%). <sup>1,3</sup>	1/23/59	(9)	2/15/80	Feb. 15-Aug. 15	2,611,663,500.00	1,453,500	2,610,240,000.00	
3 1/2% 1980 (Effective Rate 3.3818%). <sup>1,3</sup>	10/3/60	(9)	11/15/80	May 15-Nov. 15	1,915,943,000.00	2,051,500.00	1,913,891,500.00	
3 1/4% 1985 (Effective Rate 3.2222%). <sup>3</sup>	6/3/58	(9)	5/15/85	do	1,134,867,500.00	5,510,500.00	1,129,357,000.00	
4 1/4% 1987-92 (Effective Rate 4.1911%). <sup>3</sup>	8/15/62	8/15/87 <sup>4</sup>	8/15/92	Feb. 15-Aug. 15	365,121,500.00		365,121,500.00	
4% 1988-93 (Effective Rate 4.0082%). <sup>3</sup>	1/17/63	2/15/88 <sup>4</sup>	2/15/93	do	250,000,000.00		250,000,000.00	
4 1/8% 1989-94 (Effective Rate 4.1904%). <sup>1,3</sup>	4/18/63	5/15/89 <sup>5</sup>	5/15/94	May 15-Nov. 15	1,560,466,000.00		1,560,466,000.00	
3 1/2% 1990 (Effective Rate 3.4907%). <sup>1,3</sup>	2/14/58	(9)	2/15/90	Feb. 15-Aug. 15	4,917,411,500.00	8,339,500.00	4,909,072,000.00	
3% 1995	2/15/55	(9)	2/15/95	do	2,745,117,000.00	249,432,000.00	2,495,685,000.00	
3 1/2% 1998 (Effective Rate 3.5153%). <sup>1,3</sup>	10/3/60	(9)	11/15/98	May 15-Nov. 15	4,462,839,000.00	18,642,500.00	4,444,196,500.00	
Total Treasury bonds					117,833,968,150.00	30,820,554,800.00	87,013,413,350.00	
Total marketable obligations					249,378,306,150.00	40,160,157,800.00	209,218,148,350.00	
Non-Marketable Obligations:								
Certificates of Indebtedness: <sup>b</sup>								
3.55% Foreign Series	12/27/63	On 2 days' notice at option of owner.	3/27/64	Mar. 27, 1964	\$100,000,000.00		\$100,000,000.00	
3.55% Foreign Series	1/2/64	do	4/2/64	Apr. 2, 1964	50,000,000.00	\$25,000,000.00	25,000,000.00	
2.74% Foreign Series	12/20/63	do	6/22/64	June 22, 1964	50,000,000.00		50,000,000.00	
3.70% Foreign Series	12/27/63	do	6/29/64	June 29, 1964	100,000,000.00		100,000,000.00	
Treasury notes: <sup>b</sup>								
3.10% Foreign Series	1/4/63	(7)	4/6/64	Apr. 6-Oct. 6	125,000,000.00		125,000,000.00	
3.63% Foreign Series	7/12/63	(7)	10/12/65	Apr. 12-Oct. 12	25,000,000.00		25,000,000.00	
3.125% Foreign Series	1/21/63	(9)	1/21/68	Jan. 21-Jul 21	58,000,000.00	47,766,577.36	10,233,422.64	
Total Foreign Series					508,000,000.00	72,766,577.36	435,233,422.64	
Certificates of Indebtedness: <sup>b</sup>								
3.54% Foreign Currency Series	10/31/63	(9)	10/30/64	Apr. 30-Oct. 30	30,120,481.92		<sup>40</sup> 30,120,481.92	

See footnotes at end of table.

TABLE X.—Statement of the public debt, February 29, 1964—Continued

[On basis of daily Treasury Statements]

Title of Loan and State of Interest	Date of Issue	Redeemable (see footnote 1)	Payable	Interest Payable	Amount Issued	Amount Retired	Amount Out standing
<b>INTEREST-BEARING DEBT<sup>a</sup>—continued</b>							
Public Issues—Continued							
Non-Marketable Obligations:—Continued							
Treasury bonds: <sup>b</sup>							
2.75% Foreign Currency Series	11/8/62		3/9/64	(23)	\$27,807,000.00		<sup>14</sup> \$27,807,000.00
3.00% Foreign Currency Series	12/7/62		3/9/64	(24)	49,933,250.00		<sup>15</sup> 49,933,250.00
3.13% Foreign Currency Series	1/24/63	(9)	4/24/64	Apr. 24—Oct. 24	49,942,500.00		<sup>16</sup> 49,942,500.00
2.82% Foreign Currency Series	1/24/63		5/25/64	(25)	30,065,750.00		<sup>17</sup> 30,065,750.00
2.82% Foreign Currency Series	4/1/63	(9)	7/1/64	Jan. 1—July 1	22,397,300.00		<sup>18</sup> 22,397,300.00
3.13% Foreign Currency Series	1/24/63	(9)	7/24/64	Jan. 24—July 24	49,942,500.00		<sup>16</sup> 49,942,500.00
2.83% Foreign Currency Series	4/4/63	(9)	9/4/64	Mar. 4—Sept. 4	23,107,500.00		<sup>11</sup> 23,107,500.00
3.23% Foreign Currency Series	4/26/63	(9)	10/26/64	Apr. 26—Oct. 26	25,154,798.76		<sup>19</sup> 25,154,798.76
3.09% Foreign Currency Series	2/14/63	(9)	11/16/64	Apr. 16—Nov. 16	49,970,000.00		<sup>16</sup> 49,970,000.00
2.82% Foreign Currency Series	5/16/63	(9)	11/16/64	May 16—Nov. 16	23,133,689.59		<sup>11</sup> 23,133,689.59
2.89% Foreign Currency Series	7/1/63	(9)	1/1/65	Jan. 1—July 1	25,414,722.05		<sup>10</sup> 25,414,722.05
3.14% Foreign Currency Series	2/14/63	(9)	2/15/65	Feb. 15—Aug. 15	49,970,000.00		<sup>16</sup> 49,970,000.00
3.27% Foreign Currency Series	3/29/63	(9)	3/29/65	Mar. 29—Sept. 29	24,962,750.00		<sup>20</sup> 24,962,750.00
3.61% Foreign Currency Series	1/20/64		4/20/65	Apr. 20—Oct. 20	23,174,433.96		<sup>11</sup> 23,174,433.96
3.26% Foreign Currency Series	5/16/63	(9)	5/16/65	May 16—Nov. 16	20,055,151.67		<sup>21</sup> 20,055,151.67
3.22% Foreign Currency Series	5/20/63	(9)	5/20/65	May 20—Nov. 20	10,029,335.81		<sup>22</sup> 10,029,335.81
3.83% Foreign Currency Series	12/11/63	(9)	6/11/65	June 11—Dec. 11	25,162,102.00		<sup>19</sup> 25,162,102.00
3.30% Foreign Currency Series	6/28/63	(9)	6/28/65	June 28—Dec. 28	74,773,268.15		<sup>12</sup> 74,773,268.15
3.55% Foreign Currency Series	7/11/63	(9)	7/11/65	Jan. 11—July 11	25,112,377.89		<sup>38</sup> 25,112,377.89
3.66% Foreign Currency Series	8/28/63	(9)	8/28/65	Feb. 28—Aug. 28	50,227,278.43		<sup>16</sup> 50,227,278.43
3.69% Foreign Currency Series	9/30/63	(9)	9/30/65	Mar. 30—Sept. 30	49,879,518.05		<sup>13</sup> 49,879,518.05
Total Foreign Currency Series					760,335,708.28		760,335,708.28
1% Treasury Certificates	Various dates: From 12/13/63.	On demand	6/15/64	June 15, 1964	5,012,568.68		5,012,568.68
4% Treasury Bonds	12/31/63	On demand	6/30/67	June 30—Dec. 31	20,000,000.00		20,000,000.00
United States savings bonds: <sup>24 a</sup> Series and approximate yield to maturity: E-1941 3.223% <sup>24</sup>	First day of each month: 5 to 12-41.	After 2 months from issue	10 years from issue date but may be		1,832,153,185.80	\$1,550,044,312.90	282,108,872.90

		date, on demand at option of owner.	held for ad- ditional period. <sup>28</sup>			
E-1942 3.252% <sup>28</sup>	1 to 12-42	do	do	8,092,225,795.17	6,871,430,078.35	1,220,795,716.82
E-1943 3.277% <sup>28</sup>	1 to 12-43	do	do	13,024,357,049.86	11,074,461,045.11	1,949,896,004.75
E-1944 3.298% <sup>28</sup>	1 to 12-43	do	do	15,175,898,880.50	12,727,581,185.43	2,448,317,695.07
E-1945 3.316% <sup>28</sup>	1 to 12-45	do	do	11,879,206,143.44	9,762,613,792.67	2,116,592,350.77
E-1946 3.327% <sup>28</sup>	1 ro 12-46	do	do	5,341,008,638.53	4,169,129,015.48	1,171,879,623.05
E-1947 3.346% <sup>28</sup>	1 to 12-47	do	do	5,034,479,601.43	3,748,837,125.44	1,285,642,475.99
E-1948 3.366% <sup>28</sup>	1 to 12-48	do	do	5,188,401,081.76	3,757,350,640.34	1,431,050,441.42
E-1949 3.344% <sup>28</sup>	1 to 12-49	do	do	5,104,850,672.44	3,609,944,771.82	1,494,905,900.62
E-1950 3.347% <sup>28</sup>	1 to 12-50	do	do	4,452,695,306.06	3,065,908,180.42	1,386,787,125.64
E-1951 3.378% <sup>28</sup>	1 to 12-51	do	do	3,855,835,646.74	2,643,430,032.03	1,212,405,614.71
E-1952 3.400% (Jan. to Apr. 1952)	1 to 4-52	do	do	1,325,123,022.43	899,910,263.26	425,212,759.17
E-1952 3.451% <sup>28</sup> (May to Dec. 1952)	5 to 12-52	do	9 years, 8 months from issue date but may be held for ad- ditional period. <sup>28</sup>	2,712,247,919.24	1,808,866,386.19	903,381,533.05
E-1953 3.468% <sup>28</sup>	1 to 12-53	do	do	4,592,031,035.39	2,913,817,655.94	1,678,213,379.45
E-1954 3.497% <sup>28</sup>	1 to 12-54	do	do	4,649,815,395.54	2,771,039,196.95	1,878,716,198.59
E-1955 3.522% <sup>28</sup>	1 to 12-55	do	do	4,807,381,203.11	2,824,397,575.61	1,982,983,627.50
E-1956 3.546% <sup>28</sup>	1 to 12-56	do	do	4,613,737,399.08	2,721,707,354.97	1,892,030,044.11
E-1957 3.560% (Jan. 1957)	1-57	do	do	382,607,063.04	217,701,320.01	164,905,743.03
E-1957 3.653% <sup>28</sup> (Feb. to Dec. 1957)	2 to 12-57	do	8 years, 11 months from issue date but may be held for ad- ditional period. <sup>28</sup>	3,952,305,818.48	2,263,395,543.01	1,688,910,275.47
E-1958 3.690% <sup>28</sup>	1 to 12-58	do	do	4,192,242,822.21	2,234,517,375.42	1,957,725,446.79
E-1959 3.730% (Jan. to May 1959)	1 to 5-59	do	do	1,679,661,207.90	884,509,079.67	795,152,128.23
E-1959 3.750% (June to Dec. 1959)	6 to 12-59	do	7 years, 9 months from issue date but may be held for ad- ditional period. <sup>28</sup>	2,239,373,327.81	1,166,413,873.01	1,072,959,454.80
E-1960 3.750%	1 to 12-60	do	do	3,899,343,801.08	1,885,952,783.63	2,013,391,017.45
E-1961 3.750%	1 to 12-61	do	do	3,911,361,147.74	1,690,268,245.72	2,221,092,902.02
E-1962 3.750%	1 to 12-62	do	do	3,761,100,258.98	1,455,373,111.98	2,305,727,147.00
E-1963 3.750%	1 to 12-63	do	do	3,830,126,923.81	853,266,929.50	2,976,859,994.31

See footnotes at end of table.



TABLE X.—Statement of the public debt, February 29, 1964—Continued

[On basis of daily Treasury Statements]

Title of Loan and State of Interest	Date of Issue	Redeemable (see footnote 1)	Payable	Interest Payable	Amount Issued	Amount Retired	Amount Out- standing
<b>INTEREST BEARING DEBT <sup>a</sup>—continued</b>							
Public Issues—Continued Non-Marketable Obligations—Continued United States savings bonds. Series and approximate yield to maturity—Continued Unclassified sales and redemptions.....					\$747,602,069.81	\$803,693,335.40	\$-56,091,265.59
Total Series E.....					130,277,172,417.38	90,375,620,210.26	39,901,552,207.12
F-1952 2.53% <sup>27</sup> .....	1 to 4-52.....	After 6 months from issue date, on demand at option of owner on 1 month's notice.	12 years from issue date.		49,361,063.61	31,651,656.11	17,709,407.50
Unclassified redemptions.....						7,393,678.67	-7,393,678.67
Total Series F.....					49,361,063.61	39,045,334.78	10,315,728.83
G-1952 2.50% <sup>27</sup> .....	1 to 4-52.....	do.....	do.....	Semiannually.....	163,428,200.00	114,711,900.00	48,716,300.00
Unclassified redemptions.....						19,854,000.00	-19,854,000.00
Total Series G.....					163,428,200.00	134,565,900.00	28,862,300.00
H-1952 3.392% <sup>28</sup> .....	6 to 12-52.....	do.....	9 years, 8 months from issue date but may be held for additional period. <sup>28</sup>	Semiannually.....	191,480,500.00	105,774,000.00	85,706,500.00
H-1953 3.409% <sup>28</sup> .....	1 to 12-53.....	do.....	do.....	do.....	470,500,500.00	228,024,000.00	242,476,500.00
H-1954 3.438% <sup>28</sup> .....	1 to 12-54.....	do.....	do.....	do.....	877,679,500.00	358,550,500.00	519,129,000.00
H-1955 3.467% <sup>28</sup> .....	1 to 12-55.....	do.....	do.....	do.....	1,173,084,000.00	440,168,500.00	732,915,500.00
H-1956 3.496% <sup>28</sup> .....	1 to 12-56.....	do.....	do.....	do.....	893,176,000.00	293,993,500.00	599,182,500.00
H-1957 3.520% (Jan. 1957).....	1-57.....	do.....	do.....	do.....	64,506,000.00	18,957,500.00	45,548,500.00
H-1957 3.628% <sup>28</sup> (Feb. to Dec. 1957).....	2 to 12-57.....	do.....	10 years from issue date.	do.....	567,682,000.00	144,412,000.00	423,270,000.00

H-1958 3.870% <sup>24</sup>	1 to 12-58	do	do	do	890,252,500.00	216,438,000.00	673,814,500.00
H-1959 3.720% (Jan. to May 1959)	1 to 5-59	do	do	do	356,318,500.00	65,694,000.00	290,624,500.00
H-1959 3.750% (June to Dec. 1959)	6 to 12-59	do	do	do	362,413,000.00	57,472,000.00	304,941,000.00
H-1960 3.750%	1 to 12-60	do	do	do	1,006,765,500.00	109,010,500.00	897,755,000.00
H-1961 3.750%	1 to 12-61	do	do	do	1,041,579,000.00	79,827,500.00	961,751,500.00
H-1962 3.750%	1 to 12-62	do	do	do	856,754,000.00	35,824,500.00	820,929,500.00
H-1963 3.750%	1 to 12-63	do	do	do	770,032,000.00	6,911,500.00	763,120,500.00
H-1964 3.750%	1 to 2-64	do	do	do	40,439,000.00	3,000.00	40,436,000.00
Unclassified sales and redemptions					89,743,500.00	27,310,000.00	62,433,500.00
Total Series H					9,652,405,500.00	2,188,371,000.00	7,464,034,500.00
Series and approximate yield to maturity: J-1952 2.76%	First day of each month: 5 to 12-52	After 6 mos from issue date on demand at option of owner on 1 month's notice.	12 years from issue date.		\$107,109,559.34	\$63,682,245.54	\$43,427,313.80
J-1953 2.76%	1 to 12-53	do	do		157,508,477.79	82,817,844.79	74,690,633.00
J-1954 2.76%	1 to 12-54	do	do		378,843,295.95	240,102,707.12	138,740,588.83
J-1955 2.76%	1 to 12-55	do	do		272,917,440.86	149,535,259.81	123,382,181.05
J-1956 2.76%	1 to 12-56	do	do		172,813,177.83	74,758,576.63	98,054,601.20
J-1957 2.76%	1 to 4-57	do	do		36,356,471.35	13,651,238.02	22,705,233.33
Unclassified redemptions						3,550,661.38	-3,550,661.38
Total Series J					1,126,548,423.12	628,098,533.29	497,449,889.83
K-1952 2.76%	5 to 12-52	do	do	Semiannually	291,932,000.00	169,697,500.00	122,234,500.00
K-1953 2.76%	1 to 12-53	do	do	do	302,931,500.00	158,247,500.00	144,584,000.00
K-1954 2.76%	1 to 12-54	do	do	do	981,680,000.00	620,866,000.00	360,814,000.00
K-1955 2.76%	1 to 12-55	do	do	do	633,925,500.00	333,658,500.00	300,267,000.00
K-1956 2.76%	1 to 12-56	do	do	do	318,825,500.00	132,826,000.00	185,999,500.00
K-1957 2.76%	1 to 4-57	do	do	do	53,978,500.00	17,675,000.00	36,303,500.00
Unclassified redemptions						6,704,500.00	-6,704,500.00
Total Series K					2,583,273,000.00	1,439,775,000.00	1,143,498,000.00
Total United States savings bonds					143,851,188,604.11	94,805,475,978.33	49,045,712,625.78
United States retirement plan bonds (investment yield 3.75%, compounded semiannually) <sup>25</sup> &	First day of each month beginning 1/1/63.	( <sup>30</sup> )	Indeterminate.		5,071,466.99	10,459.38	5,061,007.61

See footnotes at end of table.

**TABLE X.—Statement of the public debt, February 29, 1964—Continued**  
 [On basis of daily Treasury Statements]

Title of Loan and State of Interest	Date of Issue	Redeemable (see footnote 1)	Payable	Interest Payable	Amount Issued	Amount Retired	Amount Out- standing
<b>INTEREST BEARING DEBT <sup>a</sup>—continued</b>							
<b>Public Issues—Continued</b>							
<b>Non-Marketable Obligations—Con.</b>							
2% Depository Bonds—First Series b.	Various dates: From 3/1952.	Option of United States or owner any time on 30 to 60 days' notice.	12 years from issue date.	June 1–Dec. 1.....	\$587,594,500.00	\$490,710,500.00	\$96,884,000.00
2% Treasury bonds—R. E. A. Series b.	Various dates: From 7/1/60.	.....do.....	.....do.....	Jan. 1–July 1.....	37,530,000.00	12,710,000.00	24,820,000.00
Treasury Bonds, Investment Series: <sup>b</sup> 2-½% A–1965.	10/1/47.....	On and after Apr. 1, 1948 on demand at option of owner on 1 month's notice.	10/1/65.....	Apr. 1–Oct. 1.....	969,960,000.00	531,505,000.00	438,455,000.00
2–3¼% B–1975–80.....	4/1/51.....	Apr. 1, 1975 exchangeable at any time at option of owner for marketable Treasury notes <sup>b</sup> 31	4/1/80.....	.....do.....	15,331,354,000.00	12,132,099,000.00	3,199,255,000.00
Total Treasury bonds, investment series.	-----	-----	-----	-----	16,301,314,000.00	<sup>32</sup> 12,663,604,000.00	3,637,710,000.00
Total non-marketable obligations.	-----	-----	-----	-----	162,076,046,848.06	108,045,277,515.07	54,030,769,332.99
Total public issues.....	-----	-----	-----	-----	411,454,352,998.06	148,205,435,315.07	263,248,917,682.99
<b>Special issues:</b>							
Civil Service Retirement Fund:							
4½% 1964 certificates.....	Various dates: From 11/1/63.	On demand.....	6/30/64.....	June 30.....	566,393,000.00	-----	566,393,000.00
4% 1964 certificates.....	From 9/1/63.	.....do.....	6/30/64.....	.....do.....	511,793,000.00	460,716,000.00	51,077,000.00
3¾% 1965 to 1968 notes.....	6/30/63.....	After 1 yr.....	6/30/65 to 6/30/68.	.....do.....	320,908,000.00	-----	320,908,000.00
3¾% 1965 to 1967 notes.....	6/30/62.....	.....do.....	6/30/65 to 6/30/67.	.....do.....	182,928,000.00	-----	182,928,000.00

2½% 1964 to 1966 notes.....	6/30/61.....	do.....	6/30/64 to 6/30/66.....	do.....	209,739,000.00		209,739,000.00
2½% 1964 & 1965 notes.....	Various dates: From 6/30/59.....	do.....	6/30/64 & 65.....	do.....	281,843,000.00		281,843,000.00
3½% 1969 to 1978 bonds.....	6/30/63.....	On demand.....	6/30/69 to 6/30/78.....	do.....	2,024,661,000.00		2,024,661,000.00
3¾% 1968 to 1977 bonds.....	6/30/62.....	do.....	6/30/68 to 6/30/77.....	do.....	1,295,200,000.00		1,295,200,000.00
2½% 1967 to 1971 & 1973 to 1976 bonds.....	6/30/61.....	do.....	6/30/67 to 6/30/71 & 6/30/73 to 6/30/76.....	do.....	1,244,744,000.00	23,221,000.00	1,221,523,000.00
2½% 1965 to 1975 bonds.....	Various dates: From 6/30/59.....	do.....	6/30/65 to 6/30/75.....	do.....	5,364,481,000.00	382,841,000.00	4,981,640,000.00
2¼% 1964 to 1968 bonds.....	From 6/30/57.....	do.....	6/30/64 to 6/30/68.....	do.....	1,740,000,000.00		1,740,000,000.00
Exchange Stabilization Fund: 3.30% 1964 certificates.....	From 2/1/64.....	do.....	3/1/64.....	Mar. 1, 1964.....	276,598,595.77	140,488,217.72	136,110,378.05
3.547% 1964 certificates.....	2/28/64.....	On 1 day's notice.....	4/1/64.....	Apr. 1, 1964.....	2,000,000.00		2,000,000.00
Federal Deposit Insurance Corpo- ration: 2% 1968 notes.....	From 12/1/63.....	After 1 yr.....	12/1/68.....	June 1-Dec. 1.....	250,709,000.00	67,288,000.00	183,421,000.00
Federal Disability Insurance Trust Fund: 3¾% 1967 notes.....	6/30/62.....	do.....	6/30/67.....	June 30-Dec. 31.....	1,349,000.00		1,349,000.00
3½% 1978 bonds.....	6/30/63.....	On demand.....	6/30/78.....	do.....	153,632,000.00		153,632,000.00
3¾% 1967 to 1977 bonds.....	Various dates: From 6/30/61.....	do.....	6/30/67 to 6/30/77.....	do.....	492,557,000.00		492,557,000.00
2½% 1967 to 1975 bonds.....	From 6/30/59.....	do.....	6/30/67 to 6/30/75.....	do.....	1,128,546,000.00		1,128,546,000.00
2¼% 1967 & 1968 bonds.....	From 6/30/57.....	do.....	6/30/67 & 68.....	do.....	67,500,000.00	10,739,000.00	56,761,000.00
Federal Home Loan Banks: 2¾% 1964 certificates.....	From 6/30/63.....	do.....	6/30/64.....	do.....	2,450,200,000.00	2,435,200,000.00	15,000,000.00
2¼% 1964 certificates.....	6/30/63.....	do.....	6/30/64.....	do.....	50,000,000.00		50,000,000.00
Federal Housing Administration: Apartment Unit Ins. Fund 2% 1966 notes.....	8/21/61.....	After 1 yr.....	6/30/66.....	do.....	850,000.00	325,000.00	525,000.00
Armed Services Housing Mtge. Ins. Fund: 2% 1965 and 1967 notes.....	Various dates: From 12/21/60.....	do.....	6/30/65 & 67.....	do.....	35,351,000.00	21,676,000.00	13,675,000.00
Experimental Housing Ins. Fund 2% 1966 notes.....	From 8/21/61.....	do.....	6/30/66.....	do.....	850,000.00	25,000.00	825,000.00
Housing Ins. Fund 2% 1965, 1967 & 1968 notes.....	From 9/6/60.....	do.....	6/30/65, 67 & 6/30/68.....	do.....	1,558,000.00		1,558,000.00
Housing Inv. Ins. Fund 2% 1967 notes.....	From 6/30/62.....	do.....	6/30/67.....	do.....	90,000.00		90,000.00
Mut. Mtg. Ins. Fund 2% 1967 notes.....	From 6/30/62.....	do.....	do.....	do.....	24,209,000.00	13,972,000.00	10,237,000.00

See footnotes at end of table.

TABLE X.—Statement of the public debt, February 29, 1964—Continued

[On basis of daily Treasury Statements]

Title of Loan and State of Interest	Date of Issue	Redeemable (see footnote 1)	Payable	Interest Payable	Amount Issued	Amount Retired	Amount Out- standing
<b>INTEREST-BEARING DEBT *—continued</b>							
<b>Special Issues—Continued</b>							
Federal Housing Administration—Con. Nat'l Def. Housing Ins. Fund 2—1966 & 1967 notes	Various dates: From 8/21/61	After 1 yr....	6/30/66 & 67...	June 30—Dec. 31...	\$1,200,000.00	\$770,000.00	\$430,000.00
Sec. 203 Home Improvement account 2% 1966 notes.	do.....	do.....	6/30/66.....	do.....	850,000.00	275,000.00	575,000.00
Sec. 220 Home Improvement account 2% 1966 notes.	do.....	do.....	do.....	do.....	850,000.00	200,000.00	650,000.00
Sec. 220 Housing Ins. Fund 2% 1964, 1965, 1967 & 1968 notes.	From 6/30/59..	do.....	6/30/64, 65, 67 & 6/30/68	do.....	2,240,000.00	485,000.00	1,755,000.00
Servicemen's Mtge. Ins. Fund 2% 1967 notes.	From 6/30/62..	do.....	6/30/67.....	do.....	3,175,000.00	1,550,000.00	1,625,000.00
Title 1 Housing Ins. Fund 2% 1966 & 1967 notes.	From 6/30/61..	do.....	6/30/66 & 67...	do.....	740,000.00	50,000.00	690,000.00
Title 1 Ins. Fund 2% 1967 notes.....	From 6/30/62..	do.....	6/30/67.....	do.....	26,549,000.00	17,928,000.00	8,623,000.00
War Housing Ins. Fund 2% 1967 notes...	From 12/27/62.	do.....	do.....	do.....	9,510,000.00	1,565,000.00	7,945,000.00
Federal Old-Age and Sur. Ins. Trust Fund:							
4½% 1964 certificates.....	11/15/63.....	On demand..	6/30/64.....	do.....	3,595,116,000.00	3,087,971,000.00	507,145,000.00
3½% 1977 & 1978 bonds.....	6/30/63.....	do.....	6/30/77 & 78.....	do.....	1,738,455,000.00	.....	1,738,455,000.00
3¾% 1975 and 1976 bonds.....	6/30/61.....	do.....	6/30/75 & 6/30/76	do.....	1,240,088,000.00	.....	1,240,088,000.00
2½% 1966 to 1975 bonds.....	Various dates: From 6/30/59	do.....	6/30/66 to 6/30/75	do.....	8,721,934,000.00	324,650,000.00	8,397,284,000.00
2¼% 1967 and 1968 bonds.....	From 6/30/57..	do.....	6/30/67 & 6/30/68	do.....	1,430,000,000.00	105,978,000.00	1,324,022,000.00
Federal Savings and Loan Ins. Corporation:							
2% 1967 & 1968 notes.....	From 7/2/62...	After 1 yr....	6/30/67 & 68.....	do.....	358,000,000.00	273,906,000.00	84,094,000.00
Foreign Service Retirement Fund:							
4% 1964 certificates.....	From 6/30/63..	On demand..	6/30/64.....	June 30.....	40,918,000.00	4,987,000.00	35,931,000.00
3% 1964 certificates.....	do.....	do.....	do.....	do.....	1,713,000.00	.....	1,713,000.00
Government Life Insurance Fund:							
3¾% 1964 & 1965 notes.....	6/30/60.....	After 1 yr....	6/30/64 & 6/30/65	do.....	1,340,000.00	.....	1,340,000.00
3½% 1964 notes.....	2/1/60.....	do.....	6/30/64.....	do.....	73,100,000.00	39,058,000.00	34,042,000.00
3¾% 1966 to 1975 bonds.....	6/30/60.....	On demand..	6/30/66 to 6/30/75	do.....	79,800,000.00	.....	79,800,000.00
3½% 1965 to 1974, 1976 & 1977 bonds....	Various dates: From 2/1/60	do.....	6/30/65 to 6/30/74, 6/30/76 & 77	do.....	848,762,000.00	.....	848,762,000.00

Highway Trust Fund:							
3½% 1964 certificates	From 10/7/63	do	6/30/64	June 30-Dec. 31	1,468,036,000.00	956,026,000.00	512,010,000.00
National Service Life Ins. Fund:							
3¾% 1964 certificates	From 1/15/64	do	6/30/64	June 30	11,821,000.00		11,821,000.00
3½% 1964 certificates	From 9/3/63	do	6/30/64	do	28,445,000.00		28,445,000.00
3¾% 1964 certificates	From 7/1/63	do	do	do	12,850,000.00		12,850,000.00
3¾% 1964 & 1965 notes	6/30/60	After 1 yr.	6/30/64 & 6/30/65	do	15,746,000.00		15,746,000.00
3% 1964 notes	2/1/60	do	6/30/64	do	379,000,000.00	164,527,000.00	214,473,000.00
3¾% 1966 to 1975 bonds	6/30/60	On demand	6/30/66 to 6/30/75	do	457,730,000.00		457,730,000.00
3¾% 1978 bonds	6/30/63	do	6/30/78	do	298,259,000.00		298,259,000.00
3¼% 1976 and 1977 bonds	6/30/62	do	6/30/76 & 6/30/77	do	430,031,000.00		430,031,000.00
3¼% 1976 bonds	6/30/61	do	6/30/76	do	343,149,000.00		343,149,000.00
3% 1965 to 1974 bonds	2/1/60	do	6/30/65 to 6/30/74	do	3,790,000,000.00		3,790,000,000.00
Railroad Ret. Acct:							
4½% 1964 certificates	Various dates: From 1/8/64	do	6/30/64	do	104,171,000.00	104,004,000.00	167,000.00
4% 1965 to 1968 notes	10/5/63	After 1 yr.	6/30/65 to 6/30/68	do	740,364,000.00	1,824,000.00	738,540,000.00
4% 1969 to 1978 bonds	10/5/63	On demand	6/30/69 to 6/30/78	do	1,850,910,000.00		1,850,910,000.00
Unemployment Trust Fund:							
3½% 1964 certificates	Various dates: From 2/8/64	On demand	6/30/64	June 30-Dec. 31	880,592,000.00		880,592,000.00
3¾% 1964 certificates	From 9/3/63	do	do	do	834,557,000.00		834,557,000.00
3¼% 1964 certificates	From 6/30/63	do	do	do	5,719,046,000.00	2,804,473,000.00	2,914,573,000.00
Vet. Special Term Insurance Fund:							
3½% 1964 certificates	From 2/3/64	do	do	June 30	2,110,000.00		2,110,000.00
3¾% 1964 certificates	Various dates: From 6/30/63	do	do	June 30	113,588,000.00	3,595,000.00	109,993,000.00
Total Special Issues					54,933,434,595.77	11,450,311,217.72	42,883,123,378.05
Total Int.-bearing debt outstanding					465,787,787,593.83	159,655,746,532.79	306,132,041,061.04

See footnotes at end of table.

TABLE X.—Statement of the public debt, February 29, 1964—Continued

[On basis of daily Treasury statements]

## MATURED DEBT ON WHICH INTEREST HAS CEASED

Old debt matured—Issued prior to April 1, 1917 (excluding Postal Savings bonds).....		<sup>33</sup> \$1,506,350.26
2½% Postal Savings bonds.....		<sup>33</sup> 360,940.00
First Liberty bonds, at various interest rates.....		<sup>33</sup> 603,350.00
Other Liberty bonds and Victory notes, at various interest rates.....		4,631,600.00
Treasury bonds, at various interest rates.....		79,304,250.00
Adjusted Service bonds of 1945.....		1,527,500.00
Treasure notes, at various interest rates.....		23,086,350.00
Certificates of indebtedness, at various interest rates.....		3,380,700.00
Treasury bills.....		23,437,000.00
Treasury savings certificates.....		<sup>33</sup> 71,450.00
Treasury tax and savings notes.....		859,625.00
United States savings bonds <sup>27</sup> .....		164,860,300.00
Armed forces leave bonds.....		7,539,225.00
		311,168,640.26
		311,168,640.26
DEBT BEARING NO INTEREST		
Special notes of the United States: <sup>34</sup>		
International Monetary Fund Series <sup>b</sup> .....		3,166,000,000.00
International Development Association Series <sup>c</sup> .....		164,261,000.00
Inter-American Development Bank Series <sup>d</sup> .....		125,000,000.00
Special bonds of the United States: <sup>34</sup>		
U.N. Children's Fund Series.....		6,000,000.00
U.N. Special Fund Series.....		37,189,267.00
Other:		
United States savings stamps.....		53,395,057.31
Excess profits tax refund bonds <sup>35 e</sup> .....		689,717.30
United States notes.....	\$346,681,016.00	
Less: Gold reserve.....	156,039,430.93	
		<sup>33</sup> 190,641,585.07
National and Federal Reserve bank notes assumed by the United States on deposit of lawful money for their retirement <sup>36</sup> .....		<sup>33</sup> 112,051,141.00
Old demand notes and fractional currency.....		<sup>33</sup> 2,018,162.72
Old series currency (Public Law 87-66, approved June 30, 1961) <sup>37</sup> .....		<sup>33</sup> 52,919,937.50
Thrift and Treasury savings stamps.....		<sup>33</sup> 3,701,510.25
		<sup>33</sup> 3,913,867,378.15
Total debt bearing no interest.....		3,913,867,378.15
Total gross debt (including \$29,252,521,614.09 debt incurred to finance expenditures of Government corporations and other agencies or which obligations of such corporations and agencies are held by the Treasury).....		310,357,077,079.45
Guaranteed obligations not owned by Treasury.....		792,852,025.00
		311,149,929,104.45
Total debt and guaranteed obligations.....		311,149,929,104.45
Deduct debt not subject to statutory limitation (see footnote 33).....		363,874,426.80
		310,786,054,677.65
Total debt subject to limitation <sup>b</sup> .....		310,786,054,677.65

<sup>1</sup> Redeemable at option of United States on and after dates indicated, unless otherwise shown, but only on interest dates on 4 months' notice.

<sup>2</sup> Treasury bills are sold by competitive bidding on a discount basis. The average sale price of these securities gives an approximate yield on a bank discount basis (360 days a year) as indicated. The yield on a true discount basis (365 days a year) is shown in the summary on Page 5.

<sup>3</sup> For price and yield of securities of this loan issued at premium or discount, see Table XI.

<sup>4</sup> Arranged according to earliest call dates.

<sup>5</sup> Redeemable at par and accrued interest to date of payment at option of representative of deceased owner's estate, provided entire proceeds of redemption applied to payment of Federal estate taxes on such estate.

<sup>6</sup> Not called for redemption on first call date. Callable on succeeding interest payment dates.

<sup>7</sup> Redeemable upon two days' notice in whole or in part for the purpose of purchasing United States certificates of indebtedness, foreign series, having a maturity of three months.

<sup>8</sup> Redeemable upon two days' notice in whole or in part for the purpose of purchasing United States promissory notes with maturities up to five years held by the Export-Import Bank of Washington.

<sup>9</sup> Redeemable upon two days' notice in whole or in part for the purpose of purchasing United States certificates of indebtedness, foreign currency series, having a maturity of three months.

<sup>10</sup> Dollar equivalent of Treasury bonds issued and payable in the amount of 110,000,000 Swiss francs.

<sup>11</sup> Dollar equivalent of Treasury bonds issued and payable in the amount of 100,000,000 Swiss francs.

<sup>12</sup> Dollar equivalent of Treasury bonds issued and payable in the amount of 46,500,000,-000 Italian lire.

<sup>13</sup> Dollar equivalent of Treasury bonds issued and payable in the amount of 31,050,000,-000 Italian lire.

<sup>14</sup> Dollar equivalent of Treasury bonds issued and payable in the amount of 120,000,000 Swiss francs.

<sup>15</sup> Dollar equivalent of Treasury bonds issued and payable in the amount of 31,000,-000,000 Italian lire.

<sup>16</sup> Dollar equivalent of Treasury bonds issued and payable in the amount of 200,000,000 Deutsche marks.

<sup>17</sup> Dollar equivalent of Treasury bonds issued and payable in the amount of 130,000,000 Swiss francs.

<sup>18</sup> Dollar equivalent of Treasury bonds issued and payable in the amount of 97,000,000 Swiss francs.

<sup>19</sup> Dollar equivalent of Treasury bonds issued and payable in the amount of 650,000,000 Austrian schillings.

<sup>20</sup> Dollar equivalent of Treasury bonds issued and payable in the amount of 15,500,-000,000 Italian lire.

<sup>21</sup> Dollar equivalent of Treasury bonds issued and payable in the amount of 1,000,000,000 Belgian francs.

<sup>22</sup> Dollar equivalent of Treasury bonds issued and payable in the amount of 500,000,000 Belgian francs.

<sup>23</sup> Interest payable semiannually and at maturity.

<sup>24</sup> Amounts issued, retired and outstanding for Series E, F and J bonds are stated at cost plus accrued discounts. Amounts issued, retired and outstanding for Series G, H and K bonds are stated at face value.

<sup>25</sup> Represents weighted average of approximate yields of bonds of various issue dates within yearly series if held to maturity or to end of applicable extension period, computed on basis of bonds outstanding June 30, 1963.

<sup>26</sup> Bonds dated May 1, 1941, through May 1, 1949, may accrue interest for additional 20 years; bonds dated on and after June 1, 1949, may accrue interest for additional 10 years.

<sup>27</sup> The face value of any yearly series of F or G bonds maturing from month to month, not currently presented for retirement, is reflected as interest-bearing debt to end of year of maturity. Thereafter, total amount outstanding is reflected as matured debt on which interest has ceased.

<sup>28</sup> Bonds dated June 1, 1952, through January 1, 1957, may be held and will earn interest for additional 10 years.

<sup>29</sup> Semiannual interest is to be added to principal. (For redemption values see table in Department Circular, Public Debt Series No. 1-63).

<sup>30</sup> Not redeemable except in case of death or disability until owner attains age 59½ years.

<sup>31</sup> May be exchanged for marketable 1½ percent 5-year Treasury notes, dated Apr. 1 and Oct. 1 next preceding date of exchange.

<sup>32</sup> Includes \$316,389 000 of securities received by Federal National Mortgage Association in exchange for mortgages.

<sup>33</sup> Not subject to statutory debt limitation.

<sup>34</sup> These securities are non-negotiable, bear no interest, and are payable on demand.

<sup>35</sup> Two series issued. First series matured Dec. 31, 1948. Second series matured Dec. 31, 1949. Bore no interest.

<sup>36</sup> Excludes \$15,000,000 National Bank Notes issued prior to July 1, 1929, and \$1,000,000 Federal Reserve Bank Notes issued prior to July 1, 1929, determined, pursuant to Act of June 30, 1961, 31 U.S.C. 912-916, to have been destroyed or irretrievably lost.

<sup>37</sup> Excludes \$1,000,000 Treasury Notes of 1890, \$9,000,000 gold certificates issued prior to January 30, 1934, \$15,000,000 silver certificates issued prior to July 1, 1929, and \$18,000,000 Federal Reserve Notes issued prior to the series of 1928, determined pursuant to Act of June 30, 1961, 31 U.S.C. 912-916, to have been destroyed or irretrievably lost.

<sup>38</sup> Dollar equivalent of Treasury bonds issued and payable in the amount of 100,000,000 Deutsche marks.

<sup>39</sup> Acceptable in payment of income and profits taxes due March 15, 1964.

<sup>40</sup> Dollar equivalent of certificates issued and payable in the amount of 130,000,000 Swiss francs.

<sup>41</sup> Acceptable in payment of income and profits taxes due June 15, 1964.

#### AUTHORIZING ACTS

\* All interest-bearing debt was authorized by the Second Liberty Bond Act, as amended.

<sup>b</sup> Issued pursuant to Act of July 31, 1945, as amended, 22 U.S.C. 286e.

<sup>c</sup> Issued pursuant to Act of June 30, 1960, 22 U.S.C. 284e.

<sup>d</sup> Issued pursuant to Act of August 7, 1959, 22 U.S.C. 283.

<sup>e</sup> Issued pursuant to Secs. 780-783, incl., Internal Revenue Code of 1939.

<sup>f</sup> Statutory debt limit, established at \$285 billion by the act approved June 30, 1959, has been temporarily increased to \$315 billion through June 29, 1964, and to \$309 billion on June 30, 1964.

#### TAX STATUS

\* Treasury bills are not considered capital assets under the Internal Revenue Code of 1954. The difference between the price paid for the bills and the amount actually received upon their sale or redemption at maturity for Federal income tax purposes is to be treated as an ordinary gain or loss for the taxable year in which the transaction occurs.

<sup>b</sup> Income derived from these securities is subject to all taxes now or hereafter imposed under the Internal Revenue Code of 1954.

<sup>i</sup> Where these obligations were issued wholly or partly in connection with advance refunding exchanges, the Secretary of the Treasury has declared, pursuant to section 1037(a) of the Internal Revenue Code of 1954, that any gain or loss on the obligations surrendered will be taken into account for Federal income tax purposes upon disposition or redemption of the (new) obligations. Issues included in such advance refundings are indicated by reference to footnote 2 in Table XI.

<sup>f</sup> Represents remainder of "strip" of additional amounts of ten series of outstanding Treasury bills, approximately \$100,000,000 maturing each week from Mar. 5 to Apr. 9, 1964.

<sup>†</sup> In addition, approximately \$100,000,000 issued on Oct. 28, 1963.



2. It was recently suggested by a witness before the Banking and Currency Committee that it would be desirable to replace this complex system of different issues with a simpler and more rational system of 91-day bills and perpetual bonds similar to the British consol. Please comment on the relative advantages of the existing and proposed debt distributions.

Assuming the reference is to marketable securities only, the proposal would replace the present variety of Treasury debt issues with only two debt instruments—91-day bills and perpetual bonds similar to the British consols. This would have the advantage of simplifying the Treasurer's public debt statement but the simplicity would, in all probability, be very expensive to the Treasury in terms of interest cost, if indeed it could be accomplished at all.

The variety of Treasury marketable debt instruments was not arrived at arbitrarily but rather reflects the needs and preferences of the large numbers and diversified types of investors in the United States. These investors have sharply different requirements. As an illustration, U.S. business corporations hold some \$21 billion of Treasury obligations, of which about 75 percent mature within a year, and another 20 percent mature between 1 and 5 years. Commercial banks hold about \$64 billion of Treasury securities, of which about 30 percent mature within 1 year and another 68 percent are in maturities between 1 and 10 years. In contrast, State and local government pension and retirement funds with about \$61½ billion in Government securities have about 10 percent of their holdings in issues under 5 years to maturity and no less than 56 percent in maturities of 20 years or over.

The suggestion also creates the problem of deciding how much of the debt should be comprised of 3-month bills and how much of perpetual bonds. Too large an amount in bills, which are close to being money, would constitute a dangerous inflationary potential. Moreover, a high concentration of debt in 3-month bills would add to the interest cost for such issues. Investors normally taking longer issues would require higher rates of return to compensate for the added inconvenience of the frequent need to reinvest.

On the other hand, there is no indication that investors would absorb substantial amounts of perpetual obligations. One of the primary attributes of Treasury securities is their liquidity in that they can be readily sold in case of need. As the maturity of an obligation lengthens, its liquidity decreases and a given rise in interest rates produces a greater decline in price. It is with this in mind that large institutional investors maintain a maturity distribution in their portfolios of Treasury securities suitable to their particular requirements. If offered no choice other than perpetual bonds beyond 3-month bills, investors would probably switch to intermediate private or State and local obligations unless they were fully compensated for the additional risk. Clearly, inducing investors to buy appreciable amounts of perpetual bonds would add substantially to the interest cost of the debt.

One other point might be made. Offering sizable amounts of perpetual obligations might lead some people to suppose that the Treasury had given up any idea of ever reducing the debt.

3. With a view to improving the distribution of the Government debt to investors throughout the country, would it not be useful for the Treasury to sell its securities through regional offices of the Treasury, Federal Reserve banks, or commercial banks at stated prices and yields?

The Treasury currently sells most of its marketable securities through the Office of the Treasurer, and with the cooperation of Federal Reserve banks and commercial banks, at stated prices and yields at the time of offering. If, however, your question implies that the Treasury should continuously sell securities at a predetermined and inflexible fixed price and yield regardless of the state of the economy, and regardless of the state of the credit and capital markets, a number of difficulties can be foreseen.

Investors have the alternative of putting their funds in private debt instruments. If interest rates on private debt obligations (corporate bonds, mortgages, etc.) were to rise appreciably after a fixed price and yield had been set on a continuous offering of Treasury securities, investors would find that the Treasury's obligations were no longer attractive and would instead place their funds in competing private or State and local governments obligations. On the other hand, if interest rates generally were subsequently to decline after the Treasury had decided on a fixed price and yield for its securities, there would be a flood of applications for Treasury issues which now would provide higher yields than other market debt instruments. In this case, the Treasury would be paying more than the market rate of interest on its obligations and would be giving buyers of Treasury bonds an unwarranted bonus.

The only way to avoid these difficulties would be to change the stated price and yield on such continuous Treasury security offerings as market conditions and interest rates changed. This would keep the Treasury securities at levels which would be attractive to investors and which would not give them more than was justified by market conditions. This is, in fact, the procedure under which the Treasury currently offers securities since it changes the terms whenever necessary to meet the market interest rate level and be competitive with yields on private investment obligations. Accordingly, we conclude that the proposal that the Treasury sell its securities at stated prices and yields fixed for long periods of time would not be a useful innovation.

4. Please comment on the proposal to include among the securities offered to investors and in a so-called index bond in which payments of interest and principal would be tied to a suitable index of the price level. Do you feel the inclusion of such a security would help reduce the interest cost of the debt?

The major distinguishing characteristics of an index bond (often called a purchasing power bond) is its redeemability at maturity, or at the end of a stated period of time, in terms of a stable amount of purchasing power rather than in terms of a designated number of dollars. In most such plans the principal amount to be returned at redemption is determined by reference to changes in a Government price index (generally, the Consumer Price Index). Proposals for an

index bond have frequently been brought forward during periods when there is an expectation of a continued sharp price rise. It has been argued at such times that a bond having a variable dollar value is desirable as a shelter for small savers who are unable to hedge against inflation by other means.

The Treasury is opposed to the issuance of a security having a principal (or a principal and an interest return) which would move up and down with changes in a price index. As noted in a reply to one of a series of questions submitted to the Treasury in 1951 by Representative Patman, then chairman of the Subcommittee on General Credit Control and Debt Management of the Joint Committee on the Economic Report, there are a number of serious disadvantages to a security of this type.

Among the most compelling arguments against such a bond is the probability that its introduction would be taken by many as an indication that the Government considered inflation an inevitable development. On the contrary, recent experience demonstrates that rapid price advances need not occur during periods of economic expansion. Wholesale prices have been virtually unchanged during the past few years, and the Consumer Price Index, which reflects significant changes in consumer preference, has risen only very little.

This record of stability has not been accidental. It is the outcome of determined efforts on the part of all sectors of the Government, and equally on the part of business and labor and other responsible groups, to avoid unnecessary advances in costs or prices. There is grave danger that the issuance of an index bond under these circumstances would undermine the present very widespread support for anti-inflationary programs and threaten not only the gains already achieved but those which can be expected from the recently enacted tax legislation.

Other disadvantages in the proposal for adding an index bond to our existing Federal debt instruments might be mentioned. Among them is the question of whether it is justifiable to single out a particular sector of the population for preferential treatment. The index bond in the form and in the amounts generally suggested would offer protection to only selected groups. Although frequently advocated to protect the aged and retired, the bonds would be of little help to those who are without funds for purchasing bonds and are dependent at best on small incomes. In the event of a substantial rise in prices, the Government would be paying a heavy cost for funds borrowed in this form without a reasonable assurance that it was furthering the broad protective purpose of the instrument to any significant extent.

The dangers of disruptive effects in other sectors of the economy likewise cannot be ignored. Doubts would be raised as to all contracts expressed in dollars, with the possibility of particularly serious consequences to savings institutions.

There is, finally, a question as to whether the Government should commit itself to liabilities of an indeterminate amount. Such a commitment would be in violation of the commonly accepted principles of financial soundness, and would need to be carefully considered in all of its implications before a responsible judgment could be arrived at.

In the final part of question 4, it is asked whether the inclusion of such a security would help reduce the interest cost of the debt. In periods such as the present when there is little expectation of an inflationary price rise, offering rates on index bonds—like those on other Treasury issues—would have to meet the test of the market. Presumably, investors would not be willing to accept appreciably lower interest rates as the price of protection against inflationary developments which they felt were unlikely to occur. In a period of rising prices, the inclusion of an index bond would by definition increase the amount of debt on which interest would have to be paid, with corresponding increases in interest charges attributable to the new bonds. This preferential arrangement would be likely to intensify upward pressures on other rates, adding further to budgetary costs for interest payments. In periods of price decline, the opposite sequence of events might occur, to the dismay of many holders of index bonds—provided the bond was made fully responsive to downswings as well as upswings in the price level.

5. Please discuss the advantages and disadvantages of offering a lottery bond to the public. This subject has come up from time to time in the course of committee hearings and it would be useful to have here the benefit of your information and analysis on the matter. How might the issuance of such a bond be handled administratively? What would be the effect of issuing such a bond upon the cost to the taxpayer of carrying the public debt?

From time to time the Treasury has received a number of proposals that would utilize a lottery device in connection with the sale of Government securities. However, there are a great many people in this country who have conscientious objections to any form of lottery or lottery-type securities, whether sponsored by the Government or by private interests. It has been the Treasury's consistent attitude that it would be inappropriate for the Federal Government to use a method of financing which would offend the ethical concepts of a very substantial portion of our population. Moreover, numerous bills concerned with various systems of lotteries have been introduced in the Congress, but public support of such measures, as reflected by congressional representatives, is lacking.

The Treasury Department also feels that employment of the lottery principle in promoting the sale of U.S. securities could seriously threaten the Treasury's savings bond program, which, since its inception in 1935, has stressed the importance of systematic savings. The Department's espousal under that program of the virtue of developing habits of thrift, particularly among small investors, would appear shallow if it were now to offer a bond whose principal attraction would be the chance to receive a substantial bonus as a result of gambling. Indeed, if lottery bonds should prove successful the likelihood is that their success would be at the expense of a substantial switchover from conventional savings bonds.

With respect to your questions regarding the administrative handling of lottery bonds and the cost of issuing such bonds, it is difficult to provide a detailed discussion of advantages and disadvantages in the absence of a specific proposal. Administrative procedures and

costs would, of course, vary depending upon the terms and conditions of any such lottery bonds. For example, the costs of a lottery bond program would depend to a large extent upon denomination size, redeemability features, limitations on purchases, marketing procedures and, of course, any tax aspects. However, it may be assumed that a successful lottery bond program would require the issuance of a large number of small denomination bonds to individual purchasers. Institutions entrusted with the funds of others and dependent upon a steady interest income would presumably not purchase lottery bonds. Also, sophisticated individual investors would probably not be interested in such an uncertain investment, especially since the statistical probability of return would be less than on conventional investments. Thus the market for lottery bonds would probably be characterized by small denomination purchasers, and the administrative costs would be correspondingly high. In fact, experience in other countries suggests that the costs of administering such a program would be substantial. This raises both economic and equity questions. The economic question is whether the Federal Government should adopt a financing plan under which an inordinate amount of the funds raised would probably be used for administering the plan, thus diverting economic resources from more productive purposes. The equity question is whether the Government should capitalize on the alleged gambling instinct of the American people by inducing them to invest in a program which, in an effort to offset high administrative costs and thus provide some net saving for the Treasury, could not provide purchasers as a group with a return comparable to other investments. A successful program—if possible at all under these circumstances—would appear to have some of the characteristics of regressive taxation.

An informative article on the subject of lotteries, including lottery bonds, has recently been published by the Tax Institute of America, and we are pleased to enclose a copy. I am sure you will find much of the discussion relevant in assessing any lottery proposal for raising public funds.

# TAX POLICY

*Wise Tax Policy Necessitates Reliable Tax Information*

Volume XXX, Nos. 4-5

April-May, 1963

## THE LOTTERY—A PERENNIAL PANACEA

MABEL WALKER

*Executive Director, Tax Institute of America*

	PAGE
ANCIENT LOTTERIES . . . . .	2
WHY LOTTERIES WERE ABOLISHED . . . . .	3
REVIVAL OF LOTTERIES . . . . .	5
LOTTERY BONDS . . . . .	6
LOTTERY PROPOSALS IN THE UNITED STATES . . . . .	7
THE 1963 NEW HAMPSHIRE LAW . . . . .	10
ARGUMENTS PRO AND CON . . . . .	12
ECONOMIC ASPECTS OF LOTTERIES . . . . .	13
THE TEST OF ADMINISTRATION . . . . .	15
THE SEARCH FOR A PAINLESS PANACEA . . . . .	16

Single copies, 50 cents. Special prices on quantity orders.

**TAX INSTITUTE OF AMERICA**

457 NASSAU STREET

PRINCETON, N. J.

## The Lottery — A Perennial Panacea

MABEL WALKER

*Executive Director, Tax Institute of America*

**I**N TIME of financial stress, the ancient lottery device is almost certain to be dredged up as a painless panacea for the revenue problem. We heard much of it during the depression thirties and during the war financing years; and we are hearing of it again as tax pressures mount to the painful stage on federal, state, and local fronts.

Proponents are impressed by the financial success of the Irish sweepstakes and other lottery schemes. They argue that the gambling instinct is universal and irrepressible; that the government is illogical in permitting gambling on racing and prohibiting it in lotteries; and that, moreover, the United States dollars being spent on foreign lottery schemes might just as well be kept at home.

Few of them seem aware of why such rigid taboos were legislated by federal and state governments in this country.

### ANCIENT LOTTERIES

Lotteries originated in Italy during the Middle Ages, but are probably an offshoot of the much earlier Biblical casting of lots. They were at first used in connection with commodities when merchants disposed of their wares by means of lottery procedure. Such lotteries, aided by permissive interpretation of church law, spread rapidly throughout Italy and were very common by the beginning of the sixteenth century. Commodity lotteries were established by various cities in Holland in the fifteenth century.

The first money lottery was probably established in Florence in 1530 for the benefit of the State. The lottery soon spread to France, Spain, Germany, and Austria. Sovereigns seized upon it as a revenue device and established a monopoly. Queen Elizabeth introduced the lottery in England in 1569.

After the French Revolution the lottery began to be opposed by liberals as a disreputable source of state funds. It was abandoned in England in 1826, in Hesse in 1832, France 1836, Sweden 1840, Bavaria 1861, and Switzerland 1865.

At the beginning of the twentieth century state lotteries were still in existence in Prussia, Italy, Saxony, Hamburg, Spain, and Hungary. The subject of abolition was being constantly discussed in Prussia, however.

Lotteries were introduced into America from England during the seventeenth century by Virginia. George Washington is reported to have invested in

lottery tickets with some success on more than one occasion. The Continental Congress in 1776 authorized a class lottery for the benefit of soldiers in the field. Columbia University, originally King's College, was founded on the proceeds of lotteries and the construction of some of the Harvard buildings was financed in this way.

Lotteries became widespread in this country in the early part of the nineteenth century. Most of the nineteenth century lotteries were for education, although a number were conducted for public works such as county and municipal buildings, streets, water supplies, and fire equipment during the early part of the century.

In 1954 the Princeton University Library presented an exhibit of materials from five separate lotteries run for the University's benefit prior to the Revolution. Only one of these lotteries, however, was run in New Jersey, as the legislators of that colony were reluctant to authorize games of chance.

Lottery revenues were also used in the eighteenth and nineteenth centuries for Brown, Columbia, Dartmouth, Dickinson, Harvard, Rutgers, St. John's, Union, William and Mary, Yale, and the Universities of Delaware, Maryland, and Pennsylvania.<sup>1</sup>

New York and Massachusetts prohibited lotteries in 1833. Other states followed their example, but the Louisiana Lottery Company continued to flourish.

In 1890 Congress passed a law which barred from the mails all letters, postal cards, circulars, lists of drawings, tickets, and other materials referring to lotteries. In test cases of the new law the Supreme Court ruled unanimously in February, 1892, that Congress could "designate what may be carried in the mails and what excluded." (*Ex parte Dupre, Rapier*, 143 U.S. 110.)

In 1892 the Louisiana legislature passed a bill prohibiting the sale of tickets after December 31, 1893. The Louisiana Lottery Company moved to Honduras at the end of 1893, but attempted to maintain operations in the United States through the use of express and freight communications. In 1895 Congress passed an additional measure closing all forms of interstate commerce to lottery companies. The law was upheld by the Supreme Court in *Champion v. Ames* in 1903.

#### WHY LOTTERIES WERE ABOLISHED

In the pro and con discussion that was rampant during the thirties and that has occurred sporadically since then, surprisingly little attention has been given to the aspects of lottery use that led to their abolition. An informative report was issued by the Justice Department in 1883. Its introductory paragraph reads as follows:

A faithful account of the rise, progress, and decline of the lottery system in the United States would furnish a melancholy chapter in the history of the American peo-

<sup>1</sup> *The New York Times*, January 17, 1954; and *The Packet* [Princeton], January 14, 1954.



ple. Few of the present generation have any adequate conception of the hold upon social and commercial institutions which the lotteries obtained in the first 30 years of this century, of the rapid growth of the gambling spirit engendered by them, of the vast evils resulting from them which overspread the country, or of that widely extended movement against them, among moral and thoughtful citizens, which culminated, before the end of the half century, in their total suppression in many States and partial suppression in others.<sup>2</sup>

According to the report, 50 cases of suicide were reported among disappointed ticket holders after the drawing for one grand lottery scheme in London.

In the Supreme Court decision in *Phalen v. Virginia* in 1850, Mr. Justice Grier said:

. . . experience has shown that the common forms of gambling are comparatively innocuous when placed in contrast with the widespread pestilence of lotteries. The former are confined to a few persons and places but the latter infests the whole community; it enters every dwelling; it reaches every class; it preys upon the hard earnings of the poor, and it plunders the ignorant and simple.

Almost three decades later in October, 1879, Chief Justice Waite in rendering the decision in *Stone v. Mississippi* said:

If lotteries are to be tolerated at all, it is no doubt better that they should be regulated by law, so that the people may be protected as far as possible against the inherent vices of the system; but that they are demoralizing in their effects, no matter how carefully regulated, cannot admit of a doubt. . . .

They are a species of gambling, and wrong in their influences. They disturb the checks and balances of a well-ordered community.

Society built on such a foundation would almost of necessity bring forth a population of speculators and gamblers, living on the expectation of what, "by the casting of lots, or by lot, chance, or otherwise," might be "awarded" to them from the accumulations of others. Certainly the right to suppress them is governmental, to be exercised at all times by those in power at their discretion.

In a letter which appeared in *The New York Times* on August 3, 1935, Christian F. Reisner said:

I found an old report of a New York committee dated 1819 in which it said: "The wickedness and infamy occasioned by lotteries has lately been exhibited in our court of justice. There we have heard of vices and frauds which dishonor human nature. Your committee is decidedly of the opinion that lotteries are the most injurious kind of taxation and the very worst species of gambling." The worst losers are the "indigent and ignorant, who are seduced, deceived and cheated out of their money when their families are often suffering for the necessities of life."

In 1809 a British parliamentary committee made the following report: "Almost every crime that can be imagined has been occasioned either directly or indirectly through the baleful influence of lotteries."

John Samuel Ezell said in a volume on the lottery:

Coincident with these features was the outbreak of spectacular examples of abuse. State after state experienced cases of mismanagement and of suicides caused by em-

<sup>2</sup> U.S. Department of Justice, *Memoranda Concerning the Rise and Decline of the Lottery System in the United States*, Washington, 1883.

bezzlement of funds to gamble in the lotteries. Public attention focused on the system and closer observation revealed the terrific levy made on the poor by the illegal, but flourishing, trade in "insurance."\* Correlation between the long lines of petitioners at the bankruptcy courts and participation in these ventures was revealed. The true evil of the lottery became more apparent: its effect upon the participants—their visionary and unreal expectations, debts, disdain for honest labor, and impetus toward crime.

Greater experience with the system also tended to deflate its reputation as a "voluntary tax, cheerfully paid." For one thing, the burden fell most heavily upon those least able to pay it. It is interesting that early labor groups fought such schemes as a pernicious form of taxation. For another, it harmed legitimate business by tying up vast sums for the purpose of raising relatively little. Then, too, with the disassociation from local control, people ceased to identify themselves with the beneficiary and it was easy to lose faith in the directors, to conclude that the only rewards went to the contractors and ticket agents.<sup>3</sup>

#### REVIVAL OF LOTTERIES

Despite a revulsion of feeling toward the lottery in many countries during the nineteenth century, it never completely died out and has been maintained for centuries in some countries. The lottery is an old and established institution in Spain, Italy, Austria, Denmark, Holland, and Mexico. The Mexican *Lotería Nacional*, founded in 1770 with the blessing of King Charles III of Spain, is nearly 200 years old. In line with the current trend to devote lottery profits to some particularly appealing purpose, profits are used for medical research, hospitals, health centers, and child-care facilities.<sup>4</sup>

The lottery movement has had a rebirth in recent decades. In addition to such hoary specimens as those mentioned above, government lotteries are now found in a number of other countries.

The lottery that is most well known and most patronized in this country is the Irish Hospitals Sweepstakes. The law authorizing it was passed in 1930. A guess has been made, based upon the ratio of winnings, that half of the tickets are sold in this country. About half of the money is used in prizes, about a fourth goes for expenses and to the promoters, and the hospitals get about a fourth. The odds against winning any prize have been estimated at more than 500 to 1.<sup>5</sup>

France reverted to a national lottery in 1933. Confronted with extraordinary demands from farmer and veteran groups and with the customary French

---

\* Mr. Ezell explains in his volume that in connection with the old lotteries in this country a policy game, similar to the numbers racket of today, was developed. This was designed to give persons too poor to buy a ticket a chance to gamble by betting some small amount, such as 10 cents, on the lottery numbers that would come up on a certain date. The effects of this so-called "insurance" were considered by contemporaries to be socially even more vicious than the lottery itself.

<sup>3</sup> John Samuel Ezell, *Fortune's Merry Wheel: The Lottery in America*, Cambridge: Harvard University Press, 1960, p. 273.

<sup>4</sup> Murray Teigh Bloom, "Mexico Spins the Wheel of Fortune," *The Reader's Digest*, September, 1960.

<sup>5</sup> Gordon Cotler, "In Ireland All Else Is Small Potatoes," *The New York Times Magazine*, June 1, 1958.

reluctance to pay taxes, the government set up a national lottery. Two million lottery tickets at 100 francs each were sold the first year. The French government turned back 120 million francs in prizes and kept 80 million francs. The ticket issue was doubled the next year, with the government still retaining 60 per cent for administrative costs and revenue.<sup>6</sup>

In Japan district governments started operating municipal lotteries in 1947.

Many governments currently using lotteries to obtain funds supplement the appeal to the gambling instinct of the citizens with an emotional one by devoting the "profits" to some popular expenditure. For example, Sweden uses its government lottery profits for social welfare and the arts.<sup>7</sup> Southern Rhodesia initiated a state lottery in 1935 and devotes 17.5 per cent of collections to charity.<sup>8</sup> Italy has lotteries for financing sports.<sup>9</sup> Several Soviet Republics have used lotteries to raise funds for housing.<sup>10</sup>

#### LOTTERY BONDS

Some countries have introduced the lottery idea as a gimmick to aid in selling government bonds. Soviet Russia, which has followed this practice for some decades, gives buyers a choice of interest or lottery tickets. Professor Paul Haensel, Northwestern University, said in a letter to the writer on October 16, 1934:

The Soviet Government is issuing practically all of its enormous public loans as lottery loans and a great number of lotteries for promoting chemical defense, roads purposes, etc., have been launched by many Soviet institutions. When I was in Soviet service I myself possessed a whole series of Soviet lottery loans because any workman or civil servant is practically compelled to subscribe lest he may have some trouble with the trade unions. See my book: *The Economic Policy of Soviet Russia*, London, King, 1930, p. 183.

In 1956 Mr. Harold Macmillan, then British Chancellor of the Exchequer, issued premium bonds on which no interest was to be paid, but 4 per cent of the total sales were set aside for prizes to bondholders. Sweden, Norway, Belgium, and Holland have also issued bonds linked with prize money.<sup>11</sup>

*The Bond Buyer* has taken a rather dim view of lottery bonds:

Bonds, finally, do not seem to be too well adapted for lotteries. British financial publications have made it plain that the premium bonds which Harold Macmillan introduced when he was Chancellor of the Exchequer have not measured up to expectations. These bonds pay no interest, but the equivalent of four per cent of outstandings is drawn every quarter and awarded as tax-free prizes. Not only have the sales been modest, but it is recognized that other forms of national savings have been hurt.

<sup>6</sup> L. M. Hussey, "France Tries the Lottery," *Harper's Monthly Magazine*, October, 1934.

<sup>7</sup> *The New York Times*, April 11, 1960.

<sup>8</sup> *The New York Times*, February 24, 1962.

<sup>9</sup> *The New York Times*, February 12, 1958.

<sup>10</sup> *The New York Times*, February 2, 1958.

<sup>11</sup> *The New York Times*, October 22, 1956.

The British premium bond was introduced, not for governmental revenue, but as a means of drawing off small sums which in the aggregate were contributing to inflationary pressures. They can be purchased in Canada, but the Canadians have been quite indifferent to them. The Mexican program, which was developed by a partner of an investment firm in the United States, combines an interest return and lottery prizes. It was fairly successful at the start but has developed some creaking joints, which may be partly political. Russia had a lottery incentive on its bonds, when that manner of financing still was in effect, but not much is known about the practical workings. Many other countries also resort to lotteries in one form or another, but nobody seems to be able to pay off national debts or perform other miracles in line with the promises and expectations of the lottery enthusiasts.<sup>12</sup>

#### LOTTERY PROPOSALS IN THE UNITED STATES

An indicated earlier, the federal government and most of the states have strict legislation against lotteries.

Despite these legal restrictions, many persons (some of them public officials) have advocated lotteries during recent decades. This agitation reached its peak during the thirties when public revenues shrank markedly and relief needs rose sharply. It came to the fore again during the war period. Since then there have always been a few lottery advocates around, but they do not seem to have attracted as large a following as in the earlier periods.

On April 11, 1934, a subcommittee of the Ways and Means Committee conducted hearings on H.R. 7316, proposing a national lottery to raise not more than \$1 billion per year. Representative Edward A. Kenney from New Jersey was the principal protagonist. In advocating the plan Mr. Kenney said:

I would not allow the matter to go to the extent that it could be called gambling. The purpose is to appeal to the country for contributions of funds which are not now available from ordinary sources, in order to meet the decent obligation of the United States.<sup>13</sup>

Mr. Kenney suggested that one and one-quarter billion tickets be sold at \$2 each. Sixty per cent of the money would be divided as prizes, with each ticket buyer having approximately one chance in 20,883 to win a prize if 5,000 prizes were awarded. The government would get the remaining 40 per cent, or \$1 billion.

Mr. Kenney submitted a number of statements from official documents and individuals in various countries having lotteries.

#### *From Spain:*

The State Lottery of the Spanish Republic represents, in the financial economy of the modern world, a truly exceptional case: for it is, in the national budget, an important, steady and almost certain source of income. The estimated receipts from this enterprise in the budget for 1932-33 amount to 420 million pesetas out of a total of receipts estimated at 4.5 billions. . . .

<sup>12</sup> *The Daily Bond Buyer*, "Lotteries and Bonds," Editorial, February 17, 1958.

<sup>13</sup> *Hearings*, p. 4.

It must be recognized that the Spanish State Lottery, due to its remarkable organization, has become a real institution in the life of the country.

The organization of the lottery warrants a description first, on account of its size, which is without parallel in any other country; second, because it has contributed, in a large measure and in spite of all obstacles, to the lasting success of the lottery.

In its present form, which superseded the old "lotto" with 90 numbers established in 1763 and definitely suppressed in 1862, the Spanish lottery goes back to 1811; but the legislation connected with it dates almost entirely from the end of the nineteenth century, as well as the general regulations, still in force today, the main provisions of which are given below.

The national lottery is considered as a normal resource of the state budget; as a counterpart, the state guarantees the payment of the prizes.

All other forms of lottery are forbidden, except with special permission.

The tickets of the national lottery are considered as state bonds payable to bearer.

For each drawing, as many numbers must be drawn as stated on the prospectus.

Prizes are represented by a certain percentage of the product of the sale of tickets (70 percent at the present time.) This percentage may be changed by a new law.

#### *From Italy:*

I want to confirm to you that we have had a national lottery in operation since the organization of the Kingdom. It is conducted with weekly extractions in the 12 most important cities.

The system in question has had no bad results on the general welfare of the people, but has offered, on the contrary, a healthy method of contentment and happiness, with the possibility of drawing a fortune, especially on the part of the people of modest means. The system is under the strictest control of the Government, and since its operation its functioning has been most regular and efficient.

Out of the operation of its lottery, the Italian Treasury has realized a net average income of about 280,000,000 lire during the past few years.

#### *From Germany:*

For many years, legalized lotteries have been conducted in various German states under the auspices of the respective governments.

As to the effect of these lotteries upon the citizenry, I can unhesitatingly state that they have been adding to the contentment of a large part of the population. Thus, their reaction upon the state of mind of the individual citizen has been a favorable one.

#### *From the Argentine Republic:*

The national lottery in Argentina was created by law no. 3313 in October 1895. It has been in progress since that time except for a short interruption. The liquid benefits of this lottery are distributed as follows:

Sixty percent of it is used for the construction and maintenance of hospitals and public asylums in the Federal Capital, Buenos Aires, and 40 percent for the same purpose in the various Provinces of Argentina.

The operation of this lottery has been very successful and satisfactory without affecting the morals, contentment, and happiness of the individual citizen.

H. R. 7316 was never reported by the Ways and Means Committee. The bill was opposed by Speaker Rainey who said: "The country has not yet been reduced to the extreme of accepting such a revenue measure."<sup>14</sup>

<sup>14</sup> Richard M. Boeckel, "Government Lotteries," *Editorial Research Reports*, May 21, 1942, p. 329.

Senator Thomas of Oklahoma and former Congressman Samuel B. Pettengill of Indiana proposed war bond lotteries in 1941 and 1942. Representative Sabath of Illinois proposed a national lottery for the duration of the war, and Representative Knutson of Minnesota proposed a permanent national lottery, the revenue from which would be used after the war to finance old-age pensions.<sup>15</sup>

Intermittent national lottery proposals have continued to be made. Representative Paul A. Fino of the Bronx has been advocating a national lottery, estimated to bring in \$10 billion in annual revenues, for the past 10 years. In May, 1962, he took the floor of the House to discuss the merits of national lotteries of 48 foreign countries.<sup>16</sup>

In 1957 Dr. Ernest van den Haag of New York University suggested using lotteries to increase the number of persons who file federal income tax returns.<sup>17</sup> This was, of course, before the IRS numbering system made a lottery device for this purpose unnecessary.

Mrs. Oliver Harriman, widow of the Wall Street financier and an active worker for charitable causes, founded the National Conference on Legalizing Lotteries in 1934. The Conference advocated lotteries for the benefit of hospitals and other institutions in all of the states.

By 1936 two other national organizations were pushing lottery proposals. The Association for Legalizing American Lotteries sponsored the Grand National Treasure Hunt, Inc., which was an attempt to conduct a lottery without coming into conflict with the law. Golden Stakes was a similar attempt. These were later outlawed by the courts.

Among the many distinguished persons advocating lotteries was the novelist Theodore Dreiser, who said in a letter to *The New York Times* (published May 4, 1937): "The country talks of balancing the budget. One way to help that result without harm to any one is to legalize all forms of lottery." Equally distinguished citizens vigorously condemned the lottery proposals.

Lottery efforts have been especially persistent in New York City. In 1934 Bronx Borough President James J. Lyons submitted a lottery-like plan for relief financing, which was approved by the Board of Aldermen, but vetoed by Mayor La Guardia on the grounds of illegality. In 1936, however, Mayor La Guardia accepted two limousines from the Grand National Treasure Hunt and expressed himself as being in favor of "honest" lotteries. The Association for Legalizing American Lotteries, which sponsored the "Hunt," had distributed about \$30,000 to hospitals and charitable institutions and it was anticipated that 100 institutions would benefit from the contest it was conducting.<sup>18</sup>

On February 25, 1938, Oscar S. Cox, Assistant Corporation Counsel of New York City, proposed an amendment to the state constitution which would

<sup>15</sup> *Ibid.*, pp. 335-37.

<sup>16</sup> *The New York Times*, May 6, 1962.

<sup>17</sup> *Fortune*, "Any Number Can Play," Editorial, LV (1957), 76.

<sup>18</sup> *The New York Times*, February 20, 1936.

permit municipalities to operate lotteries for city hospitals. Numerous other lottery proposals were made in New York City in succeeding years: including one to lift policemen's pay in 1946; one for hospitals in 1948; for general city purposes in 1950; for hospitals and medical needs in 1951; and for city purposes in 1953. In 1952 Robert Moses, City Construction Coordinator and Chairman of the State Council of Parks, expressed the opinion that lotteries would have to be permitted for financing hospitals, and bingo for churches.<sup>19</sup>

During the thirties lotteries were also considered by the legislatures of several states, including Illinois, Maine, Maryland, Massachusetts, Missouri, Nevada, Pennsylvania, Rhode Island, and Wyoming, and by a number of cities. Some of the purposes to be served by lottery proposals have been relief in Wyoming in 1934; boosting sales tax collections in Ohio in 1937; old age assistance in Massachusetts in 1940; financing a veterans' bonus in New Jersey in 1949; schools in New Jersey in 1958; and schools in New York in 1961.

During the forties and fifties, some private lottery enterprises sprang into existence without waiting for legal authority.

On February 25, 1940, Philadelphia detectives arrested a man in Upper Darby, Pennsylvania, with lottery tickets totalling nearly \$1 million.

"We found 50,000 books of a so-called 'American Civic Society for Peace and Democracy' lottery valued at \$600,000, and 5,000 books of a 'Brunswick semi-monthly charity awards' drawing," the detectives said.

"We know the 'Civic Society' lottery is a complete fake and we know the Brunswick lottery never awards the big prizes—only the small ones."<sup>20</sup>

Federal Bureau of Investigation agents and local police uncovered various other illicit lottery operations during the forties and fifties.

#### THE 1963 NEW HAMPSHIRE LAW

It is a matter of some curiosity that the rock-ribbed state of New Hampshire, which throughout our history has projected a state image of virtue, thrift, and self-reliance, should be the first and so far the only state to enact a lottery law in this century; and to do it admittedly as a means of shifting a large part of its tax burden to residents of other states.

A lottery law was passed by both houses in 1955, but was vetoed by Governor Dwinell. Another measure passed both houses in April, 1963, and was signed by Governor John W. King on April 30. The bill provides for a semi-annual sweepstakes with revenues earmarked for education. Tickets are to be sold at state liquor stores or at pari-mutuel windows. "All concerned are agreed the bulk of sweepstakes tickets must be purchased by nonresidents if the lottery is to prove successful."<sup>21</sup>

The governor will name a three-member Sweepstake Commission to

<sup>19</sup> *The New York Times*, June 21, 1952.

<sup>20</sup> *The New York Times*, February 26, 1940.

<sup>21</sup> *The New York Times*, April 21, 1963.

supervise the operation. It may be a year before lottery tickets are available for purchase. The plan was described as follows:

There would be two horse races a year, with total prizes of \$200,000, at Rockingham Park in Salem, just across the state line from Massachusetts.

The tickets would not cost more than \$3 apiece and they could be purchased only at the state-operated liquor stores in New Hampshire or at the three race tracks in the state.

Out-of-state residents could buy the tickets—but not through the mails, since that would be illegal.

The tickets would be drawn in a lottery and then assigned to the horses in the sweepstakes races.

The proceeds—estimated to be about \$4 million—would go to local school districts.

Still to be worked out are a number of rules and regulations. Gov. King, for example, suggested that the number of tickets which may be sold to any one person might be limited. Also, he suggested the possibility of offering nonresident ticket purchasers the option of signing their tickets and depositing them with agents of the Sweepstakes Commission in the state.

And one major roadblock is still in the way of the sweepstakes. There is no money to set it up. The Legislature would have to pass another bill, authorizing salaries and other expenditures to put the sweepstakes into operation.<sup>22</sup>

Governor King said in a special speech to the legislature:

As for those who raise the fear of undesirable elements invading our state, I firmly believe the fear is without foundation. I am convinced that we can conduct an honest and respectable operation that will have the tendency to discourage those who seek to gain in this field.

To which *The New York Herald Tribune* responded in an editorial entitled "The Shame of New Hampshire":

Come now, Governor! Some of New Hampshire's sad experiences with horse racing hardly support such optimism.<sup>23</sup>

Proponents of the measure claim that it will produce about \$4 million a year in state revenues. If the ratio of awards and administrative costs to total take is comparable to that in the Irish Sweepstakes, a net yield of this amount would be conditional upon a gross take of \$16 million, necessitating annual sales of more than 5 million tickets at \$3 per ticket. New Hampshire has a population of 607,000 persons. There appears, therefore, no reason to question the accuracy of the forecast that the bulk of the tickets must be purchased by nonresidents if the revenue goal is to be realized. One is inclined to doubt, however, whether several million tickets a year can be sold to nonresidents without some conflict with federal laws.

New Hampshire's immediate neighbors have shown considerable interest in the development.

In Maine the chief of the state police and the state Attorney General said steps

<sup>22</sup> *The New York Herald Tribune*, May 1, 1963.

<sup>23</sup> *The New York Herald Tribune*, May 1, 1963.



would be taken against counterfeit tickets. They warned that possession of lottery tickets is illegal in Maine. They said the law would be strictly enforced.<sup>24</sup>

Massachusetts has a vital concern in the matter since the races will be held just across the boundary line from that state.

A similar sweepstakes bill is pending before the Vermont Legislature.

#### ARGUMENTS PRO AND CON

Lottery advocates argue that the gambling instinct is universal and cannot be stamped out; that it would be better to have government lotteries honestly run than underworld gambling operations; that the lotteries add color and zest to the humdrum lives of the poor; that money now going to foreign lotteries would be kept at home; and that the lottery is a painless and voluntary method of raising public revenue. They claim that there is glaring inconsistency in the governmental attitudes toward lotteries and other forms of gambling such as betting on horse or dog races.

The arguments have remained largely unchanged for many years, as can be seen from the following quotations:

In England, from which the system in this country was derived, a lottery bill was embraced in the program of every session of Parliament as a resource for revenue from 1709 to 1824. It was advocated by the statesmen of succeeding administrations, and justified upon the ground that there was always floating in society a given quantity of vicious inclinations which it was right to turn to account and that as the spirit of gambling was rife it was justifiable in finance to make it contribute to public burdens.<sup>25</sup>

A few weeks ago British Chancellor of the Exchequer Reginald Mauding said in introducing the budget in the House of Commons:

I have been looking at the whole field with the purpose of discovering a general system of taxing gambling which will be both fair and effective. . . . There is a growing feeling which I share that gambling is a form of expenditure which should contribute to the rising cost of social and other Government spending.<sup>26</sup>

The major arguments against the lottery are that it encourages gambling, particularly among the rank and file poor, who are less likely to bet on races or to patronize underworld gambling agencies; that the burden falls mainly upon the poor; and that the costs of administration are excessively high.

Sir William Petty, a British economist, pointed out as far back as the seventeenth century the special burden of lotteries upon the poor and ignorant:

A lottery is properly a tax upon unfortunate self-conceited fools. The world abounds in such fools; it is not fit that every man that will may cheat every man that would be cheated. Rather it is ordained that the Sovereign should have guard of these fools, even as in the case of lunatics and idiots.<sup>27</sup>

<sup>24</sup> *The New York Herald Tribune*, May 1, 1963.

<sup>25</sup> U.S. Department of Justice, *op. cit.*

<sup>26</sup> *The New York Times*, April 4, 1963.

<sup>27</sup> Quoted by E. R. A. Seligman, *Principles of Economics*, New York, 1906, p. 564.

The late Senator Richard L. Neuberger said:

Three basic reasons dictate against [a federal lottery]: (1) It would collect funds not from those best able to pay but from those least able to resist the temptation to gamble. (2) It would have an unfortunate impact upon the nation's standard of living, because many of the people pouring their incomes into the federal lottery would be heads of families. (3) Such an example set by the government of the United States would inevitably encourage state and local governments to depend on the same unsound method to fill in the exchequers.<sup>28</sup>

The condemnatory comment of the New Jersey Commission on State Tax Policy sums up much of the opposition to lotteries:

It [the lottery] is perhaps the most socially destructive form of gambling that has been devised. It may well impoverish more people, have more insidious effects on public life, deplete most rapidly the legitimate tax bases of a community, and be more widely susceptible to fraudulence, cheating, and manipulation than other gambling devices. . . . It would, moreover, fall heaviest on those least able to pay, and could promise no certainty or continuity of yield. It places the government precisely in the same position as the operator of a gambling house—the game must be “fixed” to raise the required revenue. . . .<sup>29</sup>

Perhaps the basic moral consideration is one of degree and relative effect. Good and bad, like hot and cold, are sometimes merely different degrees of the same thing. Many persons can invest a few dollars in racing or in gambling and for them it will be merely a harmless form of diversion. This is particularly true if the rewards are minor. But the lure of winning a fortune for the expenditure of a small sum on a lottery ticket, the easy procurability of tickets, and the sensational news stories concerning the large sums won by lucky ticket holders (with no corresponding publicity on the plight of the losers), constitute a much greater incentive to gambling, and particularly to gambling on the part of those who cannot afford it.

Moreover, it is also true that there are many persons for whom gambling, after exposure to it, becomes a compulsive urge, comparable to alcoholism and narcotics addiction. Because society has been unable to stamp out any of these practices does not mean that the government should go into the business of making them readily available, or that it should not attempt to make illegal the manifestations of each that have been demonstrated to be most dangerous to the populace. Although outright prohibition proved unwise, the government does impose certain restrictions on the sale of liquor. There is considerable testimony from the past indicting the lottery as the most “pernicious” form of gambling.

#### ECONOMIC ASPECTS OF LOTTERIES

Surprisingly little attention has been paid by either side to the economic aspects of the lottery. In the flood of news stories and correspondence on the

<sup>28</sup> Richard L. Neuberger, “No National Lottery,” *Christian Century*, April 30, 1958, p. 530.

<sup>29</sup> New Jersey, Commission on State Tax Policy, *Fourth Report*, pp. 16-17.

subject appearing in *The New York Times* during the past three decades, few persons have commented on this aspect. An exception was the following letter signed by Leopold Heinemann, which appeared in the March 26, 1951, issue.

The suggestion that New York City operate a lottery for the benefit of its hospitals was apparently made without any study of the profits to be realized from lotteries.

In the past I had occasion to study such enterprises as the Prussian-South German State Lottery, the Spanish State and the Argentine State Lotteries. The following is an average table of the distribution of the capital employed:

	Per Cent.
Contemplated profit . . . . .	20
Winnings . . . . .	27.5
Federal taxes . . . . .	12.5
Cost, publicity . . . . .	20
Distribution . . . . .	20

To realize a gain of, say, \$20,000,000 it is necessary to employ a capital of \$100,000,000, at five drawings annually. The full ticket would cost \$120. There would have to be 833,333 tickets. With the average purchaser buying one-eighth of a ticket in five installments at \$3 each it would be necessary to have 33,333,320 such one-eighth tickets for sale.

The lottery would require 833 bonded collectors or brokers, each to sell 1,000 full or 40,000 one eighth tickets. The annual investment of the individual player would have to be five times \$3, or \$15 for all five drawings. And the entire lottery would require 6,666,664 ticket purchasers.

Since the proposed lottery would be legal only in New York City, with a population of a little over 8,000,000, it is doubtful whether the entire number of tickets could be absorbed. On a smaller scale the entire scheme would not be worth while.

In a letter which appeared in *The New York Times* on September 20, 1934, Ralph E. Shikes said:

It [the lottery in New York State abolished in 1833-34] gained but little actual revenue for the State, as the expenses and overhead were enormous, and the people would not support a lottery unless most of the money came back to them in prizes. Just how the administration hopes to make from \$10,000,000 to \$20,000,000 is not clear. Tickets worth three or four times that sum will have to be purchased. Furthermore, it should be realized that while the lottery is going on enormous amounts of money are withdrawn from circulation.

It was supposed to be a tax for the benefit of the poor, but the poorer classes themselves were the ones who bought and will buy most of the tickets. Witness the economic status of those Americans who have won prizes in the Irish Sweepstakes and Canadian lotteries.

In the interesting volume on lotteries by John Samuel Ezell, the following statement was made:

But if history teaches anything, a study of the over thirteen hundred legal lotteries held in the United States proves these things: They cost more than they brought in if their total impact on society is reckoned; and that one hundred and sixty years' experience indicates clearly that the most careful supervision cannot eradicate the inevitable abuses in a system particularly susceptible to fraud.<sup>30</sup>

<sup>30</sup> John Samuel Ezell, *op. cit.*, pp. 280-81.

Lotteries do not generate money. The vast sums raised by them must be taken out of the income stream. Unless the time comes when the ubiquitous social security number is affixed to every ticket sold, it may never be possible to trace the impact of lottery financing upon different income groups. But it does seem indisputable that vast numbers of persons pay for tickets, but that few win any prizes—in his 1934 proposal Congressman Kenney estimated that one out of 20,883 persons buying tickets would win—and that in the more successful lotteries the charitable or governmental project supposed to be benefited gets only about one-fourth of the money spent. This is an extremely costly way of financing such ventures.

Moreover, some of the estimates made concerning the revenues to be obtained may be somewhat exaggerated. For example, the 1934 Kenney bill provided for a lottery to produce up to \$1 billion per year. The suggested price per ticket was \$2.00 of which the government would retain 80 cents, expending the remaining \$1.20 in prizes. There appears to have been no allowance for administrative costs, but if they had amounted to 25 per cent of the total sales, as they do in connection with some lotteries, the government would have netted only 30 cents per ticket. At that rate, it would have been necessary to sell six and two-thirds billion tickets in order for the government to clear \$1 billion. Since, because of age limits and other restrictions incorporated in the proposal, the market would have been restricted to about 40 million persons, that would mean each would have to purchase some 167 tickets. Even the most enthusiastic sponsor of the plan could hardly have hoped for that.

#### THE TEST OF ADMINISTRATION

Anyone accustomed to reading the daily papers may well wonder whether ethical standards in this country are sufficiently high to stand the moral stresses and strains of administering lotteries.

A two-day visit to Massachusetts in 1962 was sufficient to get an earful of unsavory stories concerning highway construction in that state; a New York City newspaper strike, resulting in interim reading of Philadelphia papers, forced the attention to allegations of zoning scandals in Philadelphia; while the resumption of newspaper publishing in New York brought stories of the New York State Liquor Authority scandal. Unfortunately, unpleasant stories of this nature are not confined to recent months nor to these three instances.

If we are continually bombarded with stories concerning malfeasance in connection with such governmental enterprises as highways, zoning, and liquor authority administration, it seems unlikely that we can achieve a more creditable performance in connection with a function that is the particular goal of underworld characters.

Without attempting to gainsay the purportedly unblemished administration of government lotteries in other countries, we must anticipate with some skepticism the ability of federal, state, or city governments in this country to come through such a rigid test unscathed.

## THE SEARCH FOR A PAINLESS PANACEA

The lottery urge is only one manifestation of the pervasive current search for Santa Claus in financing public services. Although we are not willing to deny ourselves governmental services, we are equally unwilling to face directly the pain of paying for those services. So the great game of dodging the financial burden becomes increasingly complicated, as painless panaceas are feverishly sought.

Yet no matter how many ingenious schemes we devise, sooner or later we learn with each of them that there is no Santa Claus and there is no panacea. In the long run, "painless" methods frequently turn out to be the most painful.

## ERRATUM

The following letter has been received from Mr. Ernest H. Johnson, Maine State Tax Assessor:

On page 4 of the February-March 1963 issue of Tax Policy you note that at least three states have granted exemptions to the aged. Among the three, you list Maine. Although I believe one of the New York City newspapers within the past year made a similar statement, I am at a loss to understand the basis for it.

There is no property tax exemption for the aged, as such, in this State. It is true that honorably discharged veterans over the age of 62 years, who otherwise qualify, are entitled to property tax exemption up to a valuation of \$3500. This is basically a veterans' exemption, however, and not an exemption for the aged. I know of no other provision in the Maine law which might be considered even incidentally as an exemption for the aged.

As a matter of fact, in the past few sessions of the Legislature, bills to provide for exemption for persons over a certain age have been introduced; but to date, none of these bills has received favorable consideration.

The information in this issue of TAX POLICY was obtained from a tax service.

# THE FEDERAL RESERVE SYSTEM AFTER 50 YEARS

MONDAY, MARCH 9, 1964

HOUSE OF REPRESENTATIVES,  
SUBCOMMITTEE ON DOMESTIC FINANCE OF THE  
COMMITTEE ON BANKING AND CURRENCY,  
*Washington, D.C.*

The subcommittee met, pursuant to recess, at 10 a.m., in room 1301, Longworth House Office Building, Hon. Wright Patman (chairman) presiding.

Present: Representatives Patman, Reuss, Hanna, Wilson, and Widnall.

The CHAIRMAN. The committee will please come to order. Doctor Warburton and Professor Gurley, you may take your places at the table, please. Professor Gurley is listed first. Professor Gurley, if you desire to put your testimony in the record and comment on it instead of reading it that will be satisfactory. But if you want to read it that will be satisfactory too, just proceed in whichever way you want to proceed. You are recognized.

## STATEMENT OF JOHN GURLEY, PROFESSOR, STANFORD UNIVERSITY

Mr. GURLEY. Thank you, Mr. Chairman. I think that I shall take the second alternative and read it. It is very short.

The CHAIRMAN. All right, sir.

Mr. GURLEY. Mr. Chairman, I am pleased to be here this morning to discuss with this committee the organizational structure of the Federal Reserve System and current monetary policy. The two topics are closely related, of course—no one knows that better than Congressman Patman—and I shall try to bear this in mind in my statement.

“Independence” is a good word, and so many people think that the independence of the Federal Reserve is a good thing. But it is not a good thing. It is like having two managers for the same baseball team, each manager independent of the other. The managers could get together for lunches once a week—that might help. Or one of them could try to offset the actions of the other—that might work a bit. Nothing of this sort, really, would correct the basic situation—the intolerable arrangement of having two managers.

That we have a separate manager for monetary policy gives rise to unreasonable situations, such as the President of the United States trying to use moral suasion on the Federal Reserve, hoping that it will not nullify the good effects of the tax reduction. That is really an absurd situation, not in the fact that the President is using a technique, moral suasion, that is presumably the tool of the Federal

Reserve, but rather in that he must try to design overall economic policy in the face of unnecessary uncertainty. That is the absurd part of it: a handicap seemingly devised by the handicapped.

The independence of the Federal Reserve has been defended on the ground that anti-inflationary policies are unpopular, and so should be carried out by an independent agency removed from immediate political pressures. This seems to mean that even though the majority of the people are against these tight monetary policies, the actions should still be carried out because some independent agency knows what is best for the people. Fiscal policies have their unpopular features, too, the same as monetary policies, but that is no reason why an agency, independent of the administration, should levy and collect our taxes. What counts is the entire package of economic policies—the overall program—and it is this program that should be designed by the administration and presented by it to the public for its approval or disapproval.

It has also been argued that the ones who pay the bills should not control the creation of money. I suppose that in some circumstances—mostly involving irresponsible governments in rather rudimentary economic settings—this argument carries some weight. But it is a foolish argument to present about responsible governments. The manner of paying for expenditures—by taxes, newly created money, or new Government debt—is a decision for the administration; it is a decision that is part and parcel of the overall economic program. Anyway, even if an administration were irresponsible, it could always irresponsibly issue new Treasury bills instead of new money to pay for its spendings; and the economic effects would be rather similar.

I am, therefore, in general agreement with Mr. Patman in his desire to bring monetary policy back into the fold. The proposal to eliminate the Open Market Committee and to concentrate all decision-making in a Federal Reserve Board seems to me to be a step in the right direction. The Board should seek information and advice from the individual Reserve banks, but it is not wise to allow bank Presidents voting power on vital issues of monetary policy.

I think, however, that the number of Board members should be reduced rather than increased. It would be better to have a small Board with the Chairman chosen by the President from its members and serving at the pleasure of the President. In this way, monetary policy would be brought into general economic decisionmaking, and decisions could be made more easily. I do not believe that the Secretary of the Treasury should be the Chairman of the Federal Reserve Board.

On other matters before this committee, I see no reason why the Federal Reserve bank stock should not be retired; but the matter does not seem to me to be of great importance.

I am in favor of allowing interest to be paid on demand deposits. When interest is prohibited, banks attempt to pay depositors in other ways, and such nonprice competition often misallocates resources. Moreover, if interest payments were allowed on demand deposits, their movement in upswings and downswings would tend to stabilize the economy. During upswings, banks would pay higher interest rates on demand deposits and so increase the public's demand to hold

the deposits; during recessions, banks would lower these interest rates and so reduce the public's demand to hold the deposits. I also think that the interest rate ceiling on time deposits should be removed.

I now wish to make a few remarks about current monetary policy.

Since 1950, the ratio of the money supply to GNP has fallen from 40 to 25 percent. This has raised interest rates across the board which in turn has been a factor in the slowdown of our output growth rate. Monetary policy has been a tightwad, doling out money in dribbles when more was called for.

Well, that's liquidity over the dam. The important question now is President Johnson's question: Will the stimulating effects of the tax reduction be swept away by a tighter monetary policy—by still higher interest rates?

I feel that interest rates this year should be no higher than they were, on the average, in 1963. And I have attempted to determine by how much the money supply must be increased this year to hold interest rates at their 1963 levels. My best guess is that the money supply must rise by about \$6 billion, which is a large amount. It means that the money supply should rise by 4 percent, from \$150.5 billion on the average in 1963 to \$156.5 billion on the average this year.

At the same time, I expect that GNP (in current prices) will rise by 7 or 7½ percent this year—to about \$630 billion. Can interest rates be held fairly stable if the money supply rises by only 4 percent when GNP rises by, say, 7 percent?

I think the answer to that is "Yes." The reason is that there will be an increase in other forms of liquidity, such as time deposits in commercial banks, mutual savings deposits, and savings and loan shares—and these liquid assets will probably continue to increase, as they have in recent years, faster than the economy's total (primary) debt. It is the ratio of these liquid assets to total debt that counts. For an increase in debt, by itself, tends to raise interest rates; and an increase in liquid assets tends to lower them. If other liquidity increases faster than total debt, the money supply needn't grow so fast to hold interest rates steady.<sup>1</sup>

Table 1 shows the relevant data. Interest rates on Government debt remained fairly stable—though very high—from 1960 to 1963. During this period, the money supply rose by about 7 percent, and GNP grew by 16 percent—more than twice as fast. It was possible for GNP to outrace the money supply and still leave interest rates about the same, because of the very rapid growth of other liquidity relative to total debt. During this period, these other liquid assets expanded by 43 percent, and total debt rose by 22 percent. (The annual rates of growth are recorded in table 2.)

<sup>1</sup> The estimating equation, from least-squares analysis, is:

$$M/GNP = 0.4957 - 0.0515 \log_{10}(r \cdot k) - 1.0384 (N/D), R^2 = 0.988$$

where  $M$  is the money supply,  $r$  is the Government bond rate,  $k$  is the lower asymptote of the liquidity preference curve and assumed to equal 2.24 percent.  $N$  is the sum of time deposits, mutual savings deposits, and savings and loan shares, and  $D$  is net public and private debt. The data come from table 1.

Also,

$$\frac{dM}{dN} = -1.0384 (GNP/D) \approx -\frac{1}{2}.$$

That is, a \$1 increase in time and savings deposits will reduce the demand for money by about one-half dollar.



An approximate rule comes out of this: if other liquidity grows twice as fast as total debt, then GNP can grow twice as fast as the money supply and still leave interest rates fairly stable.

Now the question is whether other liquidity in 1964 will continue to expand twice as rapidly as total debt. I think not. The extraordinary rise in time and savings deposits in the past few years has depended upon a reduction in reserve requirements on time deposits, two increases in the interest-rate ceiling on these deposits, an innovation in savings deposits (the negotiable certificate of deposit), and a somewhat sluggish economy. All of these factors are likely to be absent or less powerful this year. On the other hand, total debt itself will probably grow less rapidly this year than last year. My guess is that other liquidity will grow by about 11 percent and total debt by about 7 percent. Thus, following our rule, the money supply will have to grow by more than one-half the growth rate of GNP. If GNP grows by 7 percent this year, a 4 percent growth in the money supply should stabilize interest rates.

Thank you, Mr. Chairman.

(The attachments to Mr. Gurley's statement follow :)

TABLE 1

	Money supply	GNP	M-GNP (percent)	Federal Government		Time and savings deposits				Net public and private debt	N/D (percent)	k=2.24 percent log10 (r-k)
				Bond yield (percent)	Bill rate (percent)	Total	Time deposits	Savings and loan shares	Mutual savings deposits			
	(1)	(2)	(3)	(4)	(5)	(6)	(7)	(8)	(9)	(10)	(11)	(12)
1950-----	114.2	284.6	40.1	2.32	1.22	69.1	36.3	13.2	19.6	469.4	14.7	-1.097
1951-----	119.2	329.0	36.2	2.57	1.55	72.6	37.2	15.0	20.4	507.2	14.3	-.481
1952-----	125.2	347.0	36.1	2.68	1.77	79.0	39.5	17.7	21.8	539.6	14.6	-.357
1953-----	128.3	365.4	35.1	2.94	1.93	87.1	42.6	21.0	23.5	570.9	15.3	-.155
1954-----	130.3	363.1	35.9	2.55	.95	96.6	46.1	25.1	25.4	599.3	16.1	-.509
1955-----	134.4	397.5	33.8	2.84	1.75	105.9	48.8	29.8	27.3	642.2	16.5	-.222
1956-----	136.0	419.2	32.4	3.08	2.66	114.2	50.5	34.6	29.1	689.9	16.6	-.076
1957-----	136.7	442.8	30.9	3.47	3.27	124.5	54.1	39.5	30.9	723.2	17.2	.090
1958-----	138.4	444.5	31.1	3.43	1.84	138.5	60.7	44.9	32.9	760.8	18.2	.076
1959-----	142.8	482.7	29.6	4.08	3.41	151.4	65.6	51.3	34.5	814.4	18.6	.265
1960-----	140.9	502.6	28.0	4.02	2.93	163.5	69.4	58.4	35.7	867.8	18.8	.250
1961-----	143.2	518.2	27.6	3.90	2.38	180.8	77.0	66.5	37.3	916.8	19.7	.220
1962-----	146.0	554.9	26.3	3.95	2.78	204.7	89.2	75.7	39.8	980.7	20.9	.233
1963-----	150.5	585.0	25.7	4.00	3.22	233.2	103.7	96.5	43.0	1,056.6	22.1	.246

Col. 1: Average of daily figures.

Col. 2: In current prices.

Col. 3: Col. 1 plus col. 2.

Col. 4: Average of daily figures.

Col. 5: Rate on new issues; average of daily figures.

Col. 6: Sum of cols. 7, 8, and 9.

Col. 7: Time deposits adjusted; average of monthly figures.

Col. 8: Savings capital; average of monthly figures.

Col. 9: Average of monthly figures.

Col. 10: Average of yearend figures.

Col. 11: Col. 6 plus col. 10.

Col. 12: r equals Federal Government bond yield.

TABLE 2

	Money supply	GNP	"Other" liquidity	Total debt
1950-51	4.4	15.6	5.1	8.1
1951-52	5.0	5.5	8.8	6.4
1952-53	2.5	5.3	10.3	5.8
1953-54	1.6	- .6	10.9	5.0
1954-55	3.1	9.5	9.6	7.2
1955-56	1.2	5.5	7.8	7.4
1956-57	.5	5.6	9.0	4.8
1957-58	1.2	.4	11.2	5.2
1958-59	3.2	8.5	9.3	7.1
1959-60	-1.3	4.1	8.0	6.6
1960-61	1.6	3.1	10.6	5.6
1961-62	2.0	7.1	13.2	6.9
1962-63	3.1	5.4	13.9	7.7
[1963-64	4.0	7.0	11.0	7.0]
1950-63 <sup>1</sup>	2.2	5.8	9.8	6.4

<sup>1</sup> Average.

The CHAIRMAN. Thank you, sir. Dr. Warburton, you may proceed, sir.

#### STATEMENT OF CLARK WARBURTON, FEDERAL DEPOSIT INSURANCE CORPORATION

Mr. WARBURTON. Mr. Chairman and members of the committee, I appreciate the opportunity to come before this committee and present some of my views on the relation of Federal Reserve operations to business fluctuations. I am here as an economist who has been interested for 45 years in monetary theory and the relation of banking developments to business fluctuations. I am not representing the Federal Deposit Insurance Corporation, where I have been employed since 1934 with responsibilities that include research on the relation of banking to business fluctuations.

My work over the past 20 years on the relation of banking and monetary policy to business fluctuations can be divided into seven phases.

1. *Statistical data on final product expenditures and the supply and rate of use of money.*—A fundamental aspect of business fluctuations is the variation in aggregate expenditures of the people of the Nation for the products of the economy. A change in the amount of such expenditures must be reflected either in a change in the supply of money or in a change in the rate at which money is used in purchasing final products. One of my major tasks in studying the relation of money to business fluctuations has been to find out what the factual data show about the extent and timing of variations in money supply, and in the rate of use of money, in relation to downswings and upswings in expenditures for final products.

The timing of changes in money supply, and in the rate of use of money, at the peaks and troughs, or cyclical turning points, in final product expenditures is significant, because it provides evidence regarding the importance of monetary policy, relative to other forces,

in generating those business fluctuations that we call business cycles. If peaks and troughs in final product expenditures are led by changes in money supply, with changes in rate of use of money lagging behind, we may reasonably conclude that monetary policy is the dominant factor inducing a business downswing or upswing. But if the basic generating force in the fluctuations we call business cycles is something else, as many economists believe, then peaks and troughs in final product expenditures should be led or accompanied by those in the rate of use of money, with the cyclical change in money supply lagging behind.

There are various ways of preparing statistical series relating to final product expenditures, money supply, and rate of use of money. I have used several variants of these measures. The series that I have found most useful are quarterly indexes of final product purchases and money holdings of business and individuals, and of the corresponding rate of use of money. These series, for the period from 1919 to 1963, inclusive, will be given and analyzed in a report now under preparation, which I hope will be completed in time to submit to this subcommittee for inclusion in the published report of these hearings.

Analysis of the data shows a typical, though not invariable, time sequence in the occurrence of the crucial turning points, or cyclical peaks and troughs. Money supply leads, followed by final product expenditures, and then by the rate of use of money. This sequence gives staunch support to the principal theory of the origin of severe business fluctuations developed prior to establishment of the Federal Reserve System; namely, that they originate in maladjustments in money supply. Even the exceptions to the typical sequence, when carefully examined and combined with an analysis of forces impinging on money supply and of business expectations based on a knowledge of such forces, support this hypothesis.

2. *Statistical data on effective bank reserves.*—If maladjustment in money supply is the dominant element in generating business fluctuations, we need to know as much as possible about the forces impinging on money supply, particularly on the major portion, bank deposits. In pursuing this question, the theory that banks tend to utilize their resources close to the limit of their reserves—which was also developed prior to establishment of the Federal Reserve System—is an obvious hypothesis to be examined. Another phase of my statistical work has therefore been preparation of a quarterly index of member bank reserves, adjusted for changes in percentage requirements, shifting of deposits among banks and accounts subject to different reserve requirements, and changes in the proportion of deposits subject to member bank reserve requirements. This series, which I have called an index of effective reserves, will also be given in the report under preparation. Again, there is a significant timing sequence; namely, that the cyclical peaks and troughs in effective bank reserves typically precede or occur in the same quarter as those in money supply.

3. *Statistical studies of banking and business fluctuations prior to 1919.*—Economists and other writers who developed, prior to World War I, the theory that business depressions and inflationary booms originate in monetary maladjustments drew upon their knowledge of contemporary banking and monetary developments. But long-term

statistical studies of bank reserves and money supply in relation to business fluctuations were needed. I have therefore done some exploratory work in locating and developing statistical data from 1781, when the Continental Congress established the Bank of North America, to 1919, along the lines of those used in my analysis for the period since 1919. The results of this exploratory work tend to support the hypothesis that serious business fluctuations are led by serious irregularities in money supply.

4. *History of the theory of monetary disequilibrium.*—The results of these statistical analyses are in conformity, as I have indicated, with the principal theory of the origin of serious business fluctuations running through two centuries of economic thought prior to 1915. A review of the development of that theory has been another phase of my work, because most contemporary economists familiar with the classical theory of economic equilibrium seem to be unacquainted with the theory of monetary disequilibrium developed about the same time.

5. *Review of various segments of general economic theory bearing on business fluctuations.*—The theory of monetary disequilibrium, as developed in the 18th and 19th centuries, placed comparatively slight stress (as causal originating forces in business fluctuations) on various factors emphasized by economists in recent years, such as Government expenditures and debt policies, variation in interest rates, maladjustment between saving and investment, speculation in corporate stocks and other properties, "administered" prices, and wage rigidities. These factors are doubtless related to business fluctuations and, consequently, another phase of my study has been an effort to analyze both contemporary and traditional views on these matters and to clarify relationships between them and changes in money supply and rate of use of money.

6. *Nature and mode of operation of forces impinging on bank reserves.*—The leadership role of bank reserves revealed by the statistical studies led me into a survey of forces impinging on such reserves. This survey has involved a review of central banking theory, techniques, policies, and criteria, including the theory underlying establishment of the Federal Reserve System, and theories involved in pronouncements and practices of Federal Reserve authorities.

7. *Methods of improving the operation of the monetary system.*—Finally, my work on the relation of banking and monetary policy to business fluctuations has led to exploration of various methods and suggestions for improving monetary policy.

I would like now to summarize my thinking on six points related to the bills under consideration by this committee.

First. Guidelines for Federal Reserve operations: In a recent talk, the Vice Chairman of the Board of Governors stated:

The role of general monetary policy is to regulate the reserves available to commercial banks, so as to promote economic growth, high levels of employment, reasonable stability of prices, and to aid in achieving equilibrium in our balance of payments. It is this responsibility, so vital to the protection of the integrity of the dollar, that has been delegated by the Congress to the Federal Reserve System.<sup>1</sup>

<sup>1</sup> C. Canby Balderston, "Money: Its Uses and Abuses," remarks at Georgia State College, Atlanta, Ga., Feb. 13, 1964.

In my reading of the Federal Reserve Act and related legislation, I have not found any such description of the System's responsibility. Instead, I find four passages, relating, respectively, to open-market operations, discounts and advances, rates of discount, and changes in reserve requirements—the first three of which refer to the “accommodation” of commerce and of business or industry and agriculture, with an additional clause (in two cases) referring to “maintenance of sound credit conditions” or “the general credit situation of the country,” and the fourth referring to prevention of “injurious credit expansion or contraction.” These passages have always been ambiguous, and for many years have been archaic, as criteria for monetary policy. The Federal Reserve Board's conception of the role of monetary policy, and of the powers and responsibilities of the System in carrying out these directions, have varied greatly from time to time.<sup>2</sup>

The Employment Act of 1946, which states the Federal Government policy of using “all practicable means” for maintaining maximum employment, production, and purchasing power is also too vague to be an appropriate congressional directive for exercise of the powers of the Federal Reserve System. The most needed change in the Federal Reserve Act is insertion of a suitable directive for policymaking.

As a directive for Federal Reserve policymaking I would suggest—

(1) A basic guide emphasizing stability of the value of the dollar and provision of a rate of growth in money supply that will best foster continuous maximum employment and production without producing instability in the value of money;

(2) Location of responsibility for technical studies needed for this purpose, including the most appropriate definition of money, the most suitable price index as a measure of the value of money, the rate at which money is used for acquisition of the goods and services constituting the national output, and the rate of growth of the real national output consonant with maximum employment, maximum use of resources, and maintenance of price stability;

(3) A directive for open-market operations and other actions affecting the reserve balances of member banks to provide such quantity of reserves as will best foster these objectives, with such variations as may be found desirable because of seasonal needs, float and other technical considerations, and other factors determined to be important at a particular time, with a proviso that there be adequate reports on the reasons for such variations and the techniques used in making allowance for them; and

(4) An interim guide, pending completion of the initial technical studies, of a growth rate in member bank reserves deemed adequate to maintain an annual growth rate of 3 percent in money supply, under a prescribed definition of “money,” with authority for the variations deemed necessary.

Second. The role of gold: Adoption of this kind of a guide and directive for Federal Reserve policy formation would make possible

<sup>2</sup> For discussions of the theory underlying establishment of the Federal Reserve System and of changes in the policy objectives of the System, see Clark Warburton, “Monetary Control Under the Federal Reserve Act,” *Political Science Quarterly*, LXI (December 1946), pp. 505-534, reprinted in “Retirement of Federal Reserve Bank Stock,” hearing before Subcommittee No. 3 of the Committee on Banking and Currency of the House of Representatives, 86th Cong., 2d sess., on H.R. 8516 and H.R. 8627, Aug. 25, 1960, pp. 301-332, and “Monetary Disturbances and Business Fluctuations in Two Centuries of American History,” in “In Search of a Monetary Constitution,” edited by Leland B. Yeager (Harvard University Press, 1962), pp. 83-93.

a relaxation of our concern for loss of gold. Its adoption would signify to residents of other countries the determination of our Government to avoid policies leading either to inflation or to deflation, and thus would reduce the incentive for foreign holders of dollars to convert them into gold. Likewise it would reduce the lingering belief among people in the United States that the gold certificate reserves of the Federal Reserve banks are needed to prevent inflation, and would help the public to accept the view of monetary experts that an outflow of gold, even to the extent of total depletion of our monetary gold stock, has no real significance with respect to maintenance of the monetary policy needed for domestic or international economic stability.

With adoption of an appropriate legislative directive for Federal Reserve operations, it would be desirable to repeal the gold certificate requirements for Federal Reserve banks. This would provide a clear recognition of the fact that the only real purpose now served by gold reserves is as a reservoir of money available for settlement of balances in international trade between countries with different currency and monetary systems, and would enhance the usefulness of gold as an international medium of exchange.

If it is felt that we should continue to give foreign owners of our money a greater guarantee of its value than we give our own people—as we do by external but not internal convertibility into gold—and at the same time eliminate worry about our potential inability to meet our gold commitment to them, we could provide foreign holders of our money a guarantee against loss of its purchasing power in the contingency of an exhaustion of our gold stock.

Third. Capital stock of Federal Reserve banks and extension of reserve requirements to all commercial banks: Retirement of the capital stock of Federal Reserve banks is desirable, but it is less important than provision of appropriate guidelines for Federal Reserve operations. The most convenient time for such retirement would be near the end of a year, when seasonal needs for additional reserves are substantial, and could be accomplished by crediting the amount of stock retired to each member bank's reserve account.

It may also be suggested the Federal Reserve banks be required to replace the retired stock—at once, or gradually over a period of 5 years, at the discretion of the Board of Governors—with additions to surplus from Federal Reserve bank earnings; and that they be required to pay to the U.S. Treasury their net earnings in excess of appropriate additions to surplus.

Under present circumstances, less than one-half of the commercial banks in the Nation are members of the Federal Reserve System. However, as I stated in a study for the Commission on Money and Credit:

It may be argued, with cogency, that central bank relations with approximately one-half of the commercial banks should not be markedly different from such relations with the others. The basic central bank privileges—exchange of assets for currency, and borrowing in case of need—should be available without discrimination to all banks with deposit obligations serving as circulating medium; and it is reasonable and equitable that the necessary cost of quantitative control should be distributed among all banks with obligations serving that function.<sup>3</sup>

<sup>3</sup> "Nonmember Banks and the Effectiveness of Monetary Policy," in *Monetary Management* (Prentice-Hall, Inc., 1963), p. 351.

The simplest method of accomplishing this is to extend to all banks having deposits subject to check or issuing demand certificates of deposit the reserve requirements and borrowing privileges of Federal Reserve member banks.

Fourth. Internal organization of the Federal Reserve System: The present division of basic decisionmaking powers between the Board of Governors of the Federal Reserve System and the Federal Open Market Committee is a relic from historical developments, and I favor the proposal to transfer the powers of the Committee to the Board. The Federal Reserve banks should continue to participate in the work of arriving at policy decisions, and this should be recognized in some formal way; such as, continuation of frequent meetings with the Board of Governors of the 12 Federal Reserve bank Presidents and such assistants and advisers as they wish to bring with them.

With improved congressional guidelines for the making of Federal Reserve policy there would, it seems to me, be no need for increasing the number of members of the Board, and the number might be reduced. The 14-year terms of office are much longer than those of members of other regulatory commissions, which range from 5 to 7 years, and a similar length of term would appear to be appropriate.

Fifth. Relation of the Federal Reserve System to the executive branch of the Government: Proper administration of monetary policy is so vital to national welfare and the success of other Government policies that it should be a responsibility of a top-ranking official and appropriately coordinated with the executive branch of the Government. Serious consideration should be given to the proposal sometimes made that the exercise of monetary power be lodged in one of the executive departments and therefore become the responsibility of a member of the President's Cabinet. But such a shift should not be made without adoption of a suitable congressional directive for monetary policy. To do so would give an executive agency and the President powers of a legislative character so broad that they would probably be unconstitutional under the decision of the Supreme Court in the *Schechter* case.

In many countries regulation of banking and the execution of monetary policy, including, directly or indirectly, management of the central bank, is a duty of the finance minister; and it may be argued that when a suitable congressional directive for monetary policy has been adopted, its execution might be placed in the Department of the Treasury. My own opinion is that it would be a great mistake to place responsibility for the Nation's monetary policy in the hands of the borrowing officer of the largest concern needing to borrow from banks, even though that concern is the Government itself.

Another possibility is to consider the Chairman of the Board of Governors of the Federal Reserve System a member of the President's Cabinet, to be appointed in the same way as other department heads. Still another, which in my opinion would be preferable, would be the grouping of the various "independent" monetary, banking, and credit agencies, and the Office of the Comptroller of the Currency, in a new department of the executive branch.

These suggestions for modification of the Federal Reserve Act are discussed in more detail, with specific proposals for amendment of



various parts of the act, in four memorandums prepared for Representative Patman while I was a temporary member of the staff of the Banking and Currency Committee in the latter part of 1962. With the permission of the chairman, I am submitting these memorandums, with a few editorial changes, to this subcommittee.<sup>4</sup>

The CHAIRMAN. They will be placed in the record. I appreciate your bringing them up.

Mr. WARBURTON. Sixth. Payment of interest on demand deposits: I do not favor removal of the prohibition of interest on demand deposits. My reasons for this opinion relate to the nature of money and the services of commercial banks in issuing obligations serving as money. To elucidate these reasons would require much more time than is available this morning. If the subcommittee wishes, I shall be glad to prepare a paper on this problem for publication in the printed report of these hearings.

The CHAIRMAN. Thank you kindly, sir. We will read the statements that you have also included in connection with your remarks.

(The memorandums referred to above are as follows:)

#### GUIDELINES FOR FEDERAL RESERVE OPERATIONS

##### SUMMARY

*Powers.*—The Federal Reserve System has had adequate power since 1917 to function as a central bank in control of monetary policy. However; until 1935 the power was diffused among the 12 Federal Reserve banks and the Federal Reserve Board, and conflicts between the banks and the Board were an obstacle to continuous good central bank policy. Some diffusion of power still exists in the division of responsibility between the Board of Governors and the Federal Open Market Committee.

*Guidelines for policy in the Federal Reserve Act.*—The legislative directive for Federal Reserve policy in the original Federal Reserve Act, the "accommodation" of commerce and business, was too vague to serve as a guide to monetary policy. Amendments to the act have done little toward provision of a less ambiguous criterion. The most needed change in the Federal Reserve Act is insertion of a suitable directive for policymaking.

*Development of policy guidelines within the Federal Reserve System.*—In view of the vagueness of statutory guidelines internal objectives and criteria have been of crucial importance in the development of Federal Reserve policy. For many years after the System began operations, its activities were focused primarily on special situations, such as financing wartime activities, which in both World Wars produced an excessive monetary expansion and price inflation, or curbing speculation, which in view of the way it was carried out produced monetary contraction and the depression of the early 1930's. It is only during the past 10 years that the Board has emphasized the provision of sufficient money in the economy to provide for growth and to offset or mitigate business fluctuations, although the latter was an objective of policy for a few years in the 1920's.

*Organization for monetary policy formation.*—Inadequacies in the development of monetary policy under the Federal Reserve System may be attributed largely to the cumbersomeness of its decisionmaking mechanism and the orientation of its informational and research services. To improve the former the powers of the System should be concentrated in the Board of Governors. To assure adequate research regarding the relation of central bank operations to business conditions—which has been a conspicuous lack in the System—new legislative guidelines should be framed in such a way so as to require such research as a continuing activity of the Board of Governors.

<sup>4</sup>These memorandums carry the titles "Guidelines for Federal Reserve Operations," "Capital Stock of Federal Reserve Banks," "Extension of Reserve Requirements to Commercial Banks Not Now Members of the Federal Reserve System," and "Proposals for Change in the Membership and Terms of Office of the Board of Governors of the Federal Reserve System and in the Relation of the System to Other Financial Agencies of the Federal Government."

*Role of interest rates in the formation of monetary policy.*—Monetary policy should attempt to be neutral with respect to interest rates, without a bias toward comparatively high or comparatively low rates, or toward alternating periods of monetary restraint and ease. The emphasis of monetary policy should be on maintenance of a sufficient quantity of money to absorb the potential output of the economy at a stable level of prices. Only in this way will a natural equilibrium rate of interest be achieved, serving to keep aggregate savings and investment in balance with each other without disturbing aggregate income and output.

*Elements of a legislative directive for Federal Reserve policy.*—Provide a basic guide emphasizing stability of the value of the dollar and provision of a rate of growth in the stock of money that will best foster continuous maximum employment and production without producing instability in the value of money. Provide for technical studies needed for this purpose, including the most appropriate definition of money, the most suitable price index as a measure of the value of money, the rate at which money is used for acquisition of the goods and services constituting the national output, and the rate of growth of the real national output consonant with maximum employment, maximum use of resources, and maintenance of price stability.

*Gold and international monetary relations.*—Adoption of a suitable directive for Federal Reserve operations and addition of stability of the value of money to the Employment Act of 1946 would signify the determination of the U.S. Government to avoid policies leading either to inflation or deflation. This would reduce the incentive of foreign holders of dollars to convert them into gold, and would make possible removal of the required gold certificate holdings of the Federal Reserve banks and thus free the entire gold stock for use as a reservoir of money for settlement of balances in international trade.

*Structure of the Federal Reserve System.*—Many suggestions may be made for improvement in the structure of the Federal Reserve System, including extension of reserve requirements to all banks with obligations used as circulating medium, modification of membership requirements, retirement of the capital stock of the Federal Reserve banks, shifting of regular examinations of State banks to another Federal agency, and more effective coordination of monetary policy with the policies of the administration and activities of other Government departments and agencies.

*Suggestions for revision of the Federal Reserve Act.*—The most needed revisions are those necessary to provide an appropriate legislative directive for monetary policy and a suitable basis for its formation and execution. Suggestions made here are confined to this problem. Recommendations on various other aspects of the Federal Reserve System will doubtless be made by the President's Committee on Financial Institutions.

*Guidelines for Federal Reserve policy.*—Specific suggestions are made for amending certain sections of the Federal Reserve Act in accord with the guidelines for policy outlined above.

*Location of decisionmaking.*—Specific suggestions are made for revision of the Federal Reserve Act to concentrate decisionmaking in the Board of Governors.

### *Powers*

Since 1917, when the reserves of member banks were concentrated in the Federal Reserve banks, the Federal Reserve System has had ample power to function as a central bank controlling, within broad limits consistent with adherence to the international gold standard and maintenance of convertibility of the currency into gold, the Nation's total quantity of money or circulating medium. At that time, this power was lodged primarily in the Federal Reserve banks, with the Federal Reserve Board acting as a coordinating agency rather than a decision-making body. The basic actions affecting member bank reserves—rediscounting and open-market operations—were exercised by the respective Federal Reserve banks.

Amendments to the Federal Reserve Act, chiefly in 1933 and 1935, shifted the center of power to the Board of Governors of the Federal Reserve System and the Federal Open Market Committee. Other amendments to the Federal Reserve Act enlarged the original discounting powers of the Federal Reserve banks and authorized them to make advances on the basis of specified collateral. Abandonment of domestic convertibility of currency into gold removed, as a practical matter, the potential limitations of the gold standard.

Federal Reserve authorities have not always recognized their ability to control the operations of member banks in such a way as to regulate the quantity

of the circulating medium and therefore to exert a powerful influence on the price level and on business conditions. In fact, in the late 1930's the Board of Governors, in statements to Congress, denied that Federal Reserve operations had any substantial effect on the money supply or on the level of prices or business stability. However, since the close of World War II the Board has recognized its power to control aggregate member bank reserve balances, and to exercise a potent influence on the supply of money.

*Guidelines for policy in the Federal Reserve Act*

The legislative guidelines provided by Congress for Federal Reserve operations have always been vague. The original act provided that rediscount rates, which were then viewed as the chief instrument of action of the Federal Reserve banks, were to "be fixed with a view of accommodating commerce and business." No criteria for open-market operations were specified. When such criteria were adopted in 1933 they were also stated in ambiguous language. "The time, character, and volume of all purchases and sales of paper \* \* \* eligible for open-market operations shall be governed with a view to accommodating commerce and business and with regard to their bearing upon the general credit situation of the country." The criterion for changes in percentage reserve requirements adopted in 1935, "to prevent injurious credit expansion or contraction," is also vague and imprecise. These provisions have remained unchanged.

In recent years Federal Reserve officials have regarded the statement of goals in the Employment Act of 1946—maximum employment, production, and purchasing power—as the basic statutory directive for Federal Reserve operations. However, this is a general statement of policy applicable to all Government departments, and is inadequate as a guide to monetary policy and Federal Reserve action. A more specific directive is needed for the operations of the Federal Reserve System.

*Development of policy guidelines within the Federal Reserve System*

In view of the vagueness of statutory guidelines, internal objectives and criteria have been of crucial importance in the development of Federal Reserve policy.

When the Federal Reserve banks were opened, their operations were directed to issuance of currency in the form of Federal Reserve notes. During World War I, and for a year after the armistice in 1918, their policies were focused primarily on financing the Government debt. The consequent monetary expansion produced a rapid rise in prices, and led the Federal Reserve Board and banks, toward the end of 1919 and during 1920, to their first attempt at control of the circulating medium through substantial increases in discount rates. The impact of this restrictive policy on business activity and employment, in the depression of 1920-21, was greater than had been anticipated.

Throughout most of the 1920's Federal Reserve officials spent much time and effort in attempting to develop guidelines for their future policies. Under the leadership of the Federal Reserve Bank of New York, attempts were made to reverse the direction of policy with sufficient frequency to maintain a substantial degree of economic stability. However, no attention appears to have been given to the need for growth in the money supply, although the policies pursued did not prevent such growth during most of the 1920's.

In 1929 and the early 1930's Federal Reserve policy shifted from an emphasis on the state of business and employment to concentration on reduction of bank loans used in speculative markets or based on securities. The measures taken drastically reduced member bank reserves, relative to the growth needed for economic stability, with disastrous results on the supply of money. The great depression was the consequence.

In the middle and late 1930's, after the change in the price of gold and its impact upon gold holdings of the Federal Reserve banks, Federal Reserve authorities were primarily concerned with preventing such holdings from resulting in an undue expansion of the money supply. Such examination as they made of the relation of Federal Reserve operations to business conditions led them to conclude that Federal Reserve influence was relatively negligible both upon the price level and upon business conditions.

In World War II the focus of Federal Reserve policy was again upon financing Government operations in wartime, with the usual consequence of a huge expansion of the money supply. Wartime price controls, rationing of goods, and controls over the use of raw materials delayed the impact of this expansion on prices.

During the past decade Federal Reserve policy, as described by officials, has been focused on three objectives: provision of a money supply adequate for growth; countercyclical variations superimposed upon the rate of growth; and particular situations, notably the balance of international payments. Federal Reserve actions in pursuit of these objectives have resulted in a more stable money supply, with some growth, than in any other period in the Nation's history for which adequate data are available, except for several years of the 1920's. Business fluctuations have also been less severe than in any other period of equal length. However, serious questions continue about the adequacy of Federal Reserve policy, particularly with respect to the rate of growth of the money supply and with respect to business fluctuations resulting from the emphasis on countercyclical policy.

*Organization for monetary policy formation*

The inadequacies in the development of monetary policy under the Federal Reserve System may be attributed largely to the character of its organization and its procedures for the formulation of monetary policy. Two aspects of its organization and procedures are particularly important—the decisionmaking mechanism and process, and the orientation of its informational and research services.

Although leadership in policy decisions was taken by the Federal Reserve Bank of New York during the 1920's and early 1930's, the diffusion of decisionmaking power among the various Federal Reserve banks and conflicts of opinion and judgment between the Federal Reserve banks and the Federal Reserve Board were serious obstacles to adequate formulation and execution of monetary policy. This diffusion of power was greatly reduced by the legislation of 1935. Discount rates at each Federal Reserve bank were required to be established every 2 weeks or oftener if deemed necessary by the Board of Governors of the Federal Reserve System and thus were made subject to frequent review and determination by the Board. The Federal Open Market Committee, which had previously consisted only of representatives of the Federal Reserve banks, was altered to include all members of the Board of Governors and five representatives of the Federal Reserve banks. This organization for decisionmaking, with its division of powers between the 7-member Board of Governors and the 12-member Open Market Committee, is unduly cumbersome. A proposal that needs serious consideration by the Congress is the shifting to the Board of Governors of the responsibilities of the Open Market Committee.

Concentration of the powers of the Federal Reserve System in the Board of Governors will not by itself produce an adequate monetary policy. Another requisite is better collection and analysis of factual data respecting the relation of the money supply to Federal Reserve policy decisions, on the one hand, and to business conditions, on the other.

One of the most serious problems in the formation of Federal Reserve policy has been a lack of adequate research regarding the relation of central bank operations to business conditions. In earlier years of the Federal Reserve System the Federal Reserve Board and the Federal Reserve banks did much pioneering research in the development of statistical measures relating to prices, production, and business activity, and in recent years they have engaged in large-scale research in the fields of flow of funds and of consumer spending decisions. However, they appear to have avoided historical studies of the relation of monetary developments and central bank policy to changing business conditions.

With the current emphasis on economic growth and mitigation of business fluctuations, detailed studies of their relation to monetary developments would appear to be an essential foundation for Federal Reserve operations. It would seem to be particularly important to make a thoroughgoing analysis of changes in the money supply relative to variations in the amount of member bank reserves, on the one hand, and relative to fluctuations in major measures of the state of the economy, such as output, employment, and gross national product, on the other. An adequate study of these relationships involves numerous technical problems directly related to money. These include the degree of monetary importance of time deposits and hence the best definition of the money supply, the most appropriate index of prices as a measure of the value of money, and appropriate measures for change in the efficiency of money or rate at which its holders use it for various types of transactions, especially for acquisition of the final products of the economy. Comparatively little study of these relationships and technical problems appears to have been conducted within the Federal Reserve System.

The lack of research on the relation of changes in the supply, velocity, and value of money to fluctuations in output, employment, and gross national product becomes most evident when inquiries are made regarding the character of the information used by the Federal Open Market Committee in arriving at its decisions. It is not known what quantitative guides, if any, the Committee uses in deciding what rate of growth in money or bank reserves is needed or how much fluctuation is desirable when they adopt differing degrees of "restraint" or "ease." The policy record of the Committee published each year in the annual report of the Board of Governors does not provide such information. This inadequacy in the analytical and statistical background for formation of monetary policy suggests that any new legislative guidelines for Federal Reserve policy should be framed in such a way as to foster—and in fact require—such research as a continuing activity of the Board of Governors.

*Role of interest rates in the formation of monetary policy*

Another important problem in the formation of monetary policy is the attention paid to interest rates. The character and execution of monetary policy both have an impact on interest rates; and one of the most controversial aspects of the process of monetary policy formation is the extent to which its impact on interest rates should be made a part of the goals of monetary policy. On this point four general views may be distinguished.

One of these is an extreme that monetary policy should be used to maintain at all times, or at least at most times, a "low" interest rate, even though this results in an expansion of the circulating medium sufficient to have inflationary effects with a consequent rise in the price level. It is argued that only by such a monetary policy can the aims of the Employment Act of 1946—maximum employment, production, and purchasing power—be achieved.

An opposite extreme view is that monetary policy should be used to keep interest rates at all times, or at least at most times, comparatively "high," even though this may have deflationary effects sufficient to produce a decline in the price level and an impact on business activity resulting, occasionally or continuously, in a substantial amount of unemployment. In support of this view it is argued that only in this way can an adequate counterforce be thrown into the economy against an inherent inflationary bias in the economy, due in part to monopolistic tendencies in business and labor organizations.

A third view is that monetary policy should be directed toward alternating periods of attempting to raise or lower interest rates. This view is usually described as the exercise of monetary restraint or of monetary ease—with the connotation, respectively, of making the borrowing of money, particularly in the form of business loans, more difficult and more costly or easier and less costly. This is a part of the countercyclical theory of "leaning against the wind," with emphasis on the markets where money is loaned, rather than on the impact of injections or withdrawals of circulating medium upon the rate of spending by individuals and enterprises.

A fourth view of the relation of interest rates to the formation of monetary policy is that no attention, or at least very little emphasis, should be given to interest rates. In this view monetary policy should attempt to be neutral with respect to interest rates and thereby permit them to fluctuate with the flow of savings and other investment funds into the money loan markets, on the one hand, and the demand for loans in those markets, on the other. It is argued in support of this view that only in this way will a natural equilibrium rate of interest be achieved, serving to keep aggregate savings and investment in balance with each other without disturbing aggregate income and output. Under this view, open-market techniques and other central bank operations should not be used to sustain or achieve any selected level or pattern of interest rates. Rather, Federal Reserve discount rates, and the yield rates at which assets are acquired or relinquished through open-market operations, should follow rates set in the general loan and investment markets.

The fourth of these views has much more support in economic theory than the others. However, few economic theorists or policymakers have given adequate attention to the conditions which are necessary to maintain the neutrality of money with respect to its influence on interest rates. In theory, it means monetary conditions that will permit continuous full use of resources, or maximum production and employment (with allowance for "frictional" adjustments), and transfer of the resulting output to final purchasers at a stable level of prices. In terms of policy, it means concentration of attention on provision of a sufficient (but not excessive) growth in the money supply, under established habits

regarding the rate of use of money and observed deviations therefrom, for absorption of the growth in output made possible by increased population, enlarged resources, and advances in productivity.

*Elements of a legislative directive for Federal Reserve policy*

The foregoing considerations lead to the following suggestions for action by Congress.

1. Centralize the decisionmaking power of the Federal Reserve System by shifting the duties of the Federal Open Market Committee to the Board of Governors.

2. Provide that the powers of the Board of Governors and the Federal Reserve banks be exercised with the objective of maintaining stability of the value of the dollar and providing a rate of growth in the stock of money that will best foster continuous maximum employment and production without introducing instability in the value of money.

3. Provide for technical studies needed for this purpose, including the most appropriate definition of money, the most suitable price index as a measure of the value of money, the rate at which money is used for acquisition of the goods and services constituting the national output, and the rate of growth of the real national output consonant with maximum employment, maximum use of resources, and maintenance of price stability.

4. Instruct the Board of Governors, in preparing directives for open-market operations of Federal Reserve banks and in other actions affecting the aggregate reserves of member banks, to provide such quantity of reserves as will best foster the objectives set forth in item 2. However, authorize the Board to allow for such variations in reserves as it may find to be desirable because of seasonal needs, technical considerations, and other factors determined to be important at any particular time, with the proviso that there be adequate reports on the reasons for such variations and the techniques used in making allowance for them.

5. In view of the fact that adequate initial technical studies will require a considerable amount of time, designate an interim guide for Federal Reserve policy in the form of an instruction to provide the amount of reserves to member banks deemed adequate to maintain a growth rate of 3 percent per year in the money supply, under a prescribed definition of money, with authority for the variations indicated above.

*Gold and international monetary relations*

In recent years it has been claimed that pursuit of a monetary policy directed toward economic expansion has been hampered by international factors reflected in the outflow of gold. The circumstances underlying the assumption that monetary restraint is necessary to check the gold outflow are (1) commitments under the Bretton Woods Agreements regarding maintenance of the value of the dollar in terms of gold and of exchange rates with other currencies consistent therewith, (2) continuance for several years of a relatively "adverse" balance of international payments, and (3) fear abroad that governmental policies in the United States will conflict so seriously with monetary stability that the value of the dollar cannot be maintained. While the presumed need for monetary restraint because of this situation has been exaggerated, improvements in our monetary system would reduce the potential future loss of gold and lessen the concern about such losses.

First, adoption of the foregoing proposals for improving the legislative directives for Federal Reserve policy, and inclusion of stability of the value of money in the objectives of the Employment Act of 1946, would signify to residents of other countries the determination of our Government to avoid policies leading either to inflation or to deflation. This would reduce the incentive for foreign holders of dollars to convert them into gold.

Second, adoption of these proposals would also reduce the lingering belief among people of the United States that the gold certificate reserves of the Federal Reserve banks are needed to prevent inflation. This would lessen the reluctance to use, if needed for international payments, sufficient gold to reduce the gold certificate holdings of the Federal Reserve banks to a level close to or below the specified 25 percent of their deposits and notes. That is to say, the public would come to realize, as financial experts have long known, that an outflow of gold, even to the extent of total depletion of our monetary gold stock, has little significance with respect to maintenance of the domestic monetary policy needed for economic stability.

Third, it would be desirable to repeal the gold certificate reserve requirements for Federal Reserve banks. This would be a clear recognition of the fact that

the only real purpose now served by gold reserves is as a reservoir of money available for settlement of balances in international trade between countries with different currency and monetary systems. It would enhance the usefulness of gold as an international medium of exchange. However, this repeal is not a matter of immediate urgency, inasmuch as the Board of Governors has the power to suspend the requirements if this should become desirable.

#### *Structure of the Federal Reserve System*

Under the requirements for Federal Reserve membership—compulsory for national banks and voluntary for State-chartered banks—less than one-half of the commercial banks of the country are members of the Federal Reserve System. The member banks, which include almost all of the large banks, hold nearly 85 percent of the assets and deposits of all commercial banks. Nevertheless, the existence of nonmember banks is sometimes considered to be an obstacle to the most effective exercise of the powers of the System for promoting the growth of the economy and the minimizing of business recessions. For this reason it is doubtless desirable to consider some method of bringing all commercial banks more directly within the scope of Federal Reserve influence.

Various difficulties would be encountered in attempting to extend compulsory Federal Reserve membership to all commercial banks. A more suitable procedure may be to extend the two major aspects of Federal Reserve membership—required maintenance of reserves at the Federal Reserve banks, and rediscounting privileges—to all commercial banks having obligations serving as circulating medium, defined as deposits subject to check and demand certificates of deposit. If this change were made, other aspects of Federal Reserve membership would not necessarily be disturbed. However, other changes might also be considered, including abolition of formal membership and retirement of member stock in the Federal Reserve banks out of the surplus or earnings of the Federal Reserve banks. Involved in such changes would be a revision of the method of appointment of the boards of directors of the Federal Reserve banks, although it would not be necessary to disturb the basic character of the present method of appointment; that is, with some of the directors appointed by the Board of Governors and others elected by banks in specified size groups.

Another problem resulting from the present structure and responsibilities of the Federal Reserve System is the time consumed by the Board of Governors in taking actions relating to individual banks. Recent proposals for shifting the regular examination of State banks that are members of the System to some other Federal agency, and perhaps also shifting decisions with respect to branches, mergers, and control of banks by holding companies, need serious scrutiny. If the Congress should consider such a shifting of powers, attention would need to be given to an appropriate means of coordination and cooperation between the Reserve authorities, which would then devote most of their attention to central banking and monetary policy, and the authorities responsible for bank supervision and decisions respecting individual banks.

There is also a problem of appropriate coordination of monetary policy with basic policies of the administration and activities of Government departments and agencies other than bank supervisory authorities. Two aspects of such coordination need consideration: of aims, and of administrative responsibility. Regarding the aims of Government monetary policy, the greatest need appears to be for a legislative clarification of the meaning of the ambiguous term "maximum purchasing power" in the Employment Act of 1946, and of the relation of this aim to that embodied in declarations of the President and Treasury officials regarding maintenance of a sound dollar. This can be done by adding maintenance of stability of the value of money to the objectives of the Employment Act of 1946.

With respect to coordination between Federal Reserve operations and policies of the administration, it is clear that the execution of monetary policy is so important a part of the responsibility of the Government that, when suitable legislative guidelines have been developed, it might well be made a duty of an official of Cabinet rank. One possibility that the Congress might consider, as an aid in improving the coordination of monetary policy with that of other administrative parts of the Government, is the grouping of the agencies dealing with money and banking and other financial institutions, most of which are now outside the executive departments, into a new department.

*Suggestions for revision of the Federal Reserve Act*

Suggestions for revision of the Federal Reserve Act may be placed in three groups: (1) those needed to provide an appropriate legislative directive for monetary policy and a suitable basis for the formation and execution of monetary policy; (2) those related to collateral aspects of Federal Reserve operations, such as the conditions of Federal Reserve membership, supervision of banks and maintenance of a competitive banking structure, and coordination of Federal Reserve policy with other agencies of the Government; and (3) those involved in a codification and rearrangement of the Federal Reserve Act.

The specific suggestions presented below for revision of the Federal Reserve Act are confined to those pertaining directly to the formulation and execution of monetary policy. The need for improvement in the method of monetary policy formation is so great that changes in the Federal Reserve Act for this purpose should not be delayed by the time required for consideration of other desirable revisions. In addition, recommendations on various aspects of the Federal Reserve Act may be expected from the President's Committee on Financial Institutions. The task assigned by the President to that Committee is "to consider what changes, if any, in governmental policy toward private financial institutions could contribute to economic stability, growth, and efficiency." In accordance with this assignment, the agenda of the Committee includes preparation of recommendations regarding such topics as reserve requirements and bank supervision, but not regarding guidelines for Federal Reserve policy nor the location of decisionmaking within the Federal Reserve System. It is the latter on which specific suggestions are made here.

*Guidelines for Federal Reserve policy*

Amend the Federal Reserve Act by adding, immediately after section 11, a new section as follows:

"Sec. 11A. (a) The powers of the Board of Governors of the Federal Reserve System and of the Federal Reserve banks shall be exercised with the objective of maintaining stability of the value of the dollar, as the unit of the system of money of the United States, and of providing a rate of growth in the stock of money that will best foster continuous maximum employment and production without producing instability in the value of money.

"(b) The Board of Governors of the Federal Reserve System, after due consideration, shall define money for the purposes of this Act. Such definition shall include all demand deposits subject to check and all negotiable demand certificates of deposit, and such other deposits as may be deemed most appropriate for the purpose of maintaining the stability and value of money.

"(c) The Board of Governors, after receiving the advice of the technical committee described in this paragraph, shall adopt a price index for its use in adapting its policies to the purpose described in paragraph (a) of this section. The technical committee shall include representatives of the Departments of Agriculture, Commerce, Labor, the Board of Governors of the Federal Reserve System, the Council of Economic Advisers, and the Division of Statistical Standards with the representative of that Division acting as chairman. The technical committee shall give due consideration to various types of price indexes, including wholesale prices, retail prices, basic commodities, and all final products, and shall report its recommendation regarding choice of an index and of the technical aspects of sampling and index number construction; such report to be made not more than two years from the date of this Act.

"(d) The Board of Governors of the Federal Reserve System shall prepare such estimates of the rate at which owners of money use their funds for acquisition of the products of the economy and particularly for the purchase of final products, and shall prepare or obtain from other Government agencies such studies of the rate of growth of the real national product, productive capacity, employment and unemployment, and unused capacity, as they deem pertinent to a determination of the annual rate of increase in the stock of money, as defined, which is most closely in accord with the objectives described in paragraph (a) of this section. Any such determination of the desirable rate of increase in the money supply shall be reviewed from time to time in light of changes in the value of the dollar as measured by the price index selected under paragraph (c) of this section.

"(e) In preparing directives for open-market operations of the Federal Reserve banks, and in other actions affecting the aggregate amount of reserves of member banks, the Board of Governors of the Federal Reserve System shall aim to



provide such quantity of reserves as will best foster the objectives set forth in paragraph (a) of this section, together with such variations as the Board shall find to be desirable because of seasonal considerations, technical considerations such as float, and such other considerations as the Board shall determine to be important to take into consideration at any particular time. The Board shall include in its Annual Report or other publications descriptions of the techniques and allowances used in estimating the desirable growth rate of aggregate member bank reserves and deviations therefrom deemed necessary because of such considerations.

"(f) As an interim guide pending completion of the studies and determinations described in paragraphs (b), (c), and (d) of this section, the Board of Governors shall endeavor to provide such reserves as are deemed adequate to maintain a growth rate of 3 per centum per year in the money supply, defined as adjusted demand deposits and currency outside banks, plus negotiable time or savings deposits with a maturity date of less than one year, adjusted to exclude so far as possible deposits and currency owned by foreigners, and with such adjustments for seasonal requirements, float, and other factors as are deemed in the judgment of the Board of Governors to be desirable."

#### *Location of decisionmaking*

1. Revise the last paragraph of section 10 of the Federal Reserve Act to exclude in the first sentence thereof the words: "and by the Federal Open Market Committee".

2. Revise section 11 of the Federal Reserve Act to add paragraph (o), as follows:

"(o) The Board of Governors of the Federal Reserve System shall hereafter exercise all of the powers and duties of the Federal Open Market Committee, which is hereby abolished."

3. Repeal section 12A of the Federal Reserve Act.

4. Amend the first paragraph of section 14 of the Federal Reserve Act by adding the following:

"No Federal Reserve bank shall engage or decline to engage in open-market operations under this section except in accordance with directives and regulations adopted by the Board of Governors of the Federal Reserve System. The Board of Governors shall consider, adopt, and transmit to the several Federal Reserve banks regulations and directives relating to the open-market transactions of such banks. The time, character, and volume of all purchases and sales of paper described in this section of this Act as eligible for open-market operations shall be governed in accordance with the principles described in section 11A of this Act."

CLARK WARBURTON.

NOVEMBER 6, 1962.

---

### CAPITAL STOCK OF FEDERAL RESERVE BANKS

#### BASIC CHARACTER OF FEDERAL RESERVE BANKS

Federal Reserve banks are usually regarded as organizations owned by the member banks which are also agencies of the Federal Government. This dual character of the Federal Reserve banks is reflected in various provisions of the original Federal Reserve Act, notably those relating to capital stock, appointment of directors, and issue of Federal Reserve notes.

The original Federal Reserve Act provided for stock subscriptions by each national bank, and by each State bank that applied for membership, in an amount equal to 6 percent of its own capital and surplus. If such subscriptions were insufficient, in the judgment of the organization committee established by the act, to provide adequate capital for the Reserve bank, the committee was authorized to offer stock for public subscription, and if the capital subscribed was still insufficient the remainder of the capital required was to be allotted to the U.S. Government. The banks subscribed for the necessary capital, and no stock was sold to the public nor allotted to the Government.

Dividends on the capital stock of the Federal Reserve banks were limited to 6 percent per year, with the remainder of the earnings of the Federal Reserve banks, after necessary expenses, divided between a franchise tax to the United States and the accumulation of surplus (to a specified limit), with the surplus becoming the property of the United States in the event of dissolution. Under

existing law, there is no franchise tax and no limit to the accumulation of surplus. However, the major portion of earnings, after necessary expenses, is paid to the U.S. Treasury as interest on Federal Reserve notes.

Of the nine directors of each Federal Reserve bank, three have always been appointed by the Federal Reserve Board, and six elected by the member (i.e., stockholding) banks. In electing such directors, the member banks do not vote, as is usual in business corporations, in proportion to the amount of stock held. The member banks in each Federal Reserve district are divided into three groups, according to capitalization, with each bank in each group entitled to one vote for a director in class A, representing the banks in its group, and to one vote for a director in class B, representing commerce, agriculture, or some other industrial pursuit.

Federal Reserve notes are commonly thought of as obligations of the respective Federal Reserve banks, which they are. However, they have a dual character, as they are also obligations of the United States. Basically, they are direct obligations of the U.S. Treasury, like the U.S. notes, or "greenbacks", that have been outstanding for a hundred years. Federal Reserve notes are issued, at the discretion of the Board of Governors of the Federal Reserve System, as advances to the respective Federal Reserve banks on the basis of collateral deposited by such banks with their Federal Reserve agents. The Federal Reserve agent at each Federal Reserve bank is one of the class C directors of the bank, appointed by the Board of Governors of the Federal Reserve System, who is designated by the Board as its agent and is required to maintain an office of the Board on the premises of the Federal Reserve bank.

#### SIGNIFICANCE OF FEDERAL RESERVE BANK STOCK

The rights attached to ownership of stock in the Federal Reserve banks are: (1) evidence of membership in the System, with the privileges and responsibilities of member banks under the original provisions of and later amendments to the Federal Reserve Act; and (2) the privilege of receiving 6 percent per year on the amount of paid-in stock, the latter being for each member bank equal to 3 percent of its own capital and surplus.

Apart from evidence of membership in the Federal Reserve System, the ownership of Federal Reserve bank stock is an extremely limited form of property right that is very different from ownership of a typical share of stock in a commercial bank or some other kind of business corporation. The right to vote for directors of the Federal Reserve bank is an attribute of membership, not of stock ownership per se. The stock cannot be sold or hypothecated, and the holder has no claim on earnings in excess of the annual 6-percent dividend. The paid-in capital stock is a minor part (less than one-third) of the capital funds of the Federal Reserve banks; the major part of their capital funds (surplus and undivided profits) is owned by the U.S. Government.

For the years from 1948 through 1961, the total amount of dividends on Federal Reserve bank stock has ranged from 6 percent to 2.5 percent of the net earnings of the Federal Reserve banks. For the same period the dividends from the stock have constituted less than one-half of 1 percent of the annual earnings of the member banks from their loans and securities held.

#### IMPORTANCE OF RETIREMENT OF CAPITAL STOCK OF THE FEDERAL RESERVE BANKS

In view of the limited rights attached to ownership of stock of the Federal Reserve banks (as distinguished from membership in the Federal Reserve System), the small portion of the earnings of Federal Reserve banks that is absorbed by dividends on their stock, and the very small part of member bank earnings derived from those dividends, it would appear to be a matter of little importance whether Federal Reserve bank stock continues to exist or is retired.

A minor advantage resulting from retirement of Federal Reserve bank stock, and substitution of a certificate of membership, would be elimination of the clerical and administrative work involved in issuing additional stock when a member bank increases, and of canceling some stock when a member bank decreases, its own capital or surplus.

The basic reason for suggesting retirement of Federal Reserve bank stock is that of making the Federal Reserve banks look less like associations of commercial bankers and more like agencies of the Federal Government. The latter is their real character, since they constitute, with the Board of Governors of the Federal Reserve System, the Nation's central bank and monetary authority.

Retirement of Federal Reserve bank stock has been recommended by the Commission on Money and Credit, which stated its viewpoint as follows:

"\* \* \* stock subscriptions are no longer needed for Reserve bank working capital and the Reserve banks are public service institutions whose operations are governed by policy considerations beyond profit. Neither the Reserve banks nor the member banks have anything to gain from the continuance of an arrangement that leaves them open to the charge that they have too direct an interest in each others' profits. \* \* \*

"The agency-clientele relationship, between a Government agency and the business concerns it both serves and regulates, is almost always, almost inevitably, close; and the more so after it has matured for decades. There are public advantages in this: regulation can be knowledgeable; its inconveniences can be minimized; personal working relationships can be easy. But the hazards of too close a relationship are also well known; conflicts of interest tempt individuals on either side of the public-private line to consult private advantage too far; organized interests among the regulated may first infiltrate and then paralyze their public regulators; even legitimate transactions and contacts risk misconstruction; parties on both sides come to take too parochial a view of the national interest. The member banks of the Reserve System are alone among nationally regulated industries in technically 'owning' the institutions that regulate them. It is better to end any vulnerable appearances forthwith. The member banks should welcome an opportunity to clarify their status in the System in this manner."<sup>1</sup>

#### RETIREMENT OF STOCK AND MEMBER BANK RESERVES

Retirement of the stock of the Federal Reserve banks would increase reserves by the amount of stock retired. The retirement could be made in the form of officers' checks or by crediting the reserve accounts of the member banks. If done by officers' checks, the member banks would deposit the checks to their reserve account or cash them, increasing their reserves in either case. At the end of September 30, 1962, the amount of Federal Reserve bank stock was \$462 million, equal to 2.3 percent of the amount of member bank reserves.

The most convenient time for retiring Federal Reserve bank stock would be near the end of the year, when seasonal needs for additional reserves are substantial. If Federal Reserve bank stock were to be retired as of December 1, there would be no need for any action to offset the increase in member bank reserves. The increase would merely take the place of a part of the seasonal need at that time of the year. From December 13, 1961, to January 3, 1962, for example, member bank reserve balances were increased by \$1,060 million. In October 1962, effective on October 25 and November 1, the required reserve percentage on savings and time deposits was reduced from 5 to 4 percent. This released an estimated \$767 million in reserves, which was expected to be absorbed by member banks in meeting seasonal demands in the closing months of the year.

#### ACCUMULATION OF SURPLUS AND PAYMENTS TO THE U.S. TREASURY

The original Federal Reserve Act limited the accumulation of surplus by Federal Reserve banks to 40 percent of their paid-in capital. This was increased in 1919 to 100 percent of the subscribed capital, equal to 200 percent of the paid-in capital, plus 10 percent of net earnings each year after that figure had been reached.

In 1933, when the surplus of the Federal Reserve banks was close to 200 percent of their paid-in capital, the limit to accumulation of surplus was removed and the franchise tax eliminated. However, the Federal Reserve banks were required to subscribe to stock of the Federal Deposit Insurance Corporation, which was charged to their surplus, reducing the surplus to slightly less than the amount of paid-in capital. From 1934 through 1946 all net earnings of the Federal Reserve banks in excess of dividends on capital stock were added to surplus, raising the surplus to 235 percent of paid-in capital.

In 1947 the Board of Governors of the Federal Reserve System adopted a policy of requiring the Federal Reserve banks to pay to the U.S. Treasury, as interest on Federal Reserve notes, about 90 percent of their earnings in excess of dividends. In consequence, the surplus of the Federal Reserve banks accumu-

<sup>1</sup>The report of the Commission on Money and Credit, "Money and Credit, Their Influence on Jobs, Prices, and Growth" (Prentice-Hall, Inc., 1961), pp. 91-92.

lated slowly, ranging at year-ends, until 1958, from 226 to 239 percent of paid-in capital. In 1959, the policy was adopted of adjusting the surplus of each Federal Reserve bank to the level of subscribed capital, i.e., to 200 percent of paid-in capital, and of paying to the Treasury all remaining earnings in excess of dividends.

As indicated above, Federal Reserve notes are direct obligations of the U.S. Treasury which are issued as advances to Federal Reserve banks. That is to say, they represent borrowings by the Federal Reserve banks from the U.S. Treasury. The original Federal Reserve Act provided that on these borrowings the Federal Reserve banks "shall pay such rate of interest \* \* \* as may be established by the Federal Reserve Board." This was amended in 1917 to provide for interest on the amount of borrowings (outstanding notes) in excess of the amount of gold or gold certificates held by the Federal Reserve agent as collateral security.

For more than 30 years the Federal Reserve banks paid no interest on their borrowings from the Treasury. The Federal Reserve Board, using the discretion lodged with it by the word "may" in the law, did not establish a rate for such interest. In 1947, when the Board of Governors first required payment of interest to the Treasury, it did not formally establish a rate. Instead, the Board required the Reserve banks to pay to the Treasury, as interest on their outstanding Federal Reserve notes, 90 percent of their net earnings after payment of dividends. This was modified in 1959 to all net earnings after dividends and after sufficient additions to surplus to maintain each Federal Reserve bank's surplus at 200 percent of its paid-in capital. For the period 1947-61, the amount paid as interest to the U.S. Treasury averaged 2.4 percent of the outstanding amount of Federal Reserve notes less gold certificate collateral. The range has been from 0.5 percent in 1947 to 5 percent in 1959.

Assuming that the existing capital and surplus of Federal Reserve banks is an amount which the Board of Governors considers reasonable, it may be anticipated that, if the capital stock should be retired, the Board of Governors would permit the Federal Reserve banks to accumulate sufficient surplus to equal the present combined paid-in capital and surplus and perhaps to add something to this surplus each year. A new criterion would be necessary to determine the annual additions to surplus.

If the capital stock of the Federal Reserve banks is retired, the Congress may wish to consider modification of the present law regarding disposition of the earnings of the Federal Reserve banks. Under present law, the Board of Governors of the Federal Reserve System has complete discretion as to the rate of interest to be paid on outstanding Federal Reserve notes (i.e., on the borrowings of Federal Reserve banks from the Treasury), and hence full discretion as to the retention of net earnings and accumulation of surplus by the Federal Reserve banks.

#### SUGGESTIONS FOR REVISION OF THE FEDERAL RESERVE ACT

Many of the references to Federal Reserve bank stock in the Federal Reserve Act are in paragraphs of the act referring to the original organization of the Federal Reserve banks. Such paragraphs are now of course obsolete, and it would make no difference in the law applicable to the present time whether or not such references to Federal Reserve bank stock are altered to refer to Federal Reserve membership. It is unnecessary, and probably undesirable, to amend such passages in a law providing for retirement of Federal Reserve bank stock. Deletion (or modification) of obsolete passages in the Federal Reserve Act, regardless of whether such passages contain references to Federal Reserve bank stock, is best handled through the regular process of codification, or by a revision and reenactment of the entire act.

Accordingly, it is suggested that a bill for retirement of Federal Reserve bank stock include a paragraph stating that such stock is to be retired as of a given date, such additional paragraphs as are necessary to describe the process of retirement and substitution of certificates of membership, and such amendments as are necessary to eliminate references to capital stock in all portions of the Federal Reserve Act that are pertinent to present conditions.

CLARK WARBURTON.

NOVEMBER 26, 1962.

EXTENSION OF RESERVE REQUIREMENTS TO COMMERCIAL BANKS NOT NOW MEMBERS OF THE FEDERAL RESERVE SYSTEM<sup>1</sup>

## RESERVE REQUIREMENTS FOR COMMERCIAL BANKS

Proposals have been made that reserve requirements applicable to banks that are members of the Federal Reserve System should be extended to all insured commercial banks.<sup>2</sup> It is recommended here, for reasons set forth below, that the required maintenance of reserves in the form and amount specified by the Federal Reserve Act and the Board of Governors of the Federal Reserve System be extended to all banks with deposits transferrable by check or used as circulating medium.

It is generally recognized that the major purposes of legal reserve requirements for commercial banks is to serve as a means of implementing monetary policy. If for this purpose it is deemed desirable to extend compulsory reserve requirements to banks not members of the System, it would seem highly illogical to limit the requirement to those nonmember banks which have voluntarily decided to participate in deposit insurance. So far as I have been able to ascertain, no valid reason for such a limitation has been put forth. The only alleged reason I have heard mentioned is doubt as to the legal power to extend the requirements to noninsured banks.

In view of court decisions regarding the power of the Federal Government to legislate on matters of monetary control, including regulation of the activities of banks having obligations that are used as circulating medium, there would seem to be no question about the legality of an extension of reserve requirements to noninsured commercial banks. In fact, for nearly 30 years Federal law has required all banks of deposit to be subject to examination and submission of reports to a State or Federal authority. A section of the Banking Act of 1933, as amended in 1959, reads as follows:

"(a) After the expiration of 1 year after June 16, 1933, it shall be unlawful—

\* \* \* \* \*

"(2) For any person, firm, corporation, association, business trust, or other similar organization to engage, to any extent whatever with others than his or its officers, agents or employees, in the business of receiving deposits subject to check or to repayment upon presentation of a passbook, certificate of deposit, or other evidence of debt, or upon request of the depositor, unless such person, firm, corporation, association, business trust, or other similar organization (A) shall be incorporated under, and authorized to engage in such business by, the laws of the United States or of any State, Territory, or District, and subjected, by the laws of the United States, or of the State, Territory, or District wherein located, to examination and regulation, or (B) shall be permitted by any State, Territory, or District to engage in such business and shall be subjected by the law of such State, Territory, or District to examination and regulation, or (C) shall submit to periodic examination by the banking authority of the State, Territory, or District where such business is carried on and shall make and publish periodic reports of its condition, exhibiting in detail its resources and liabilities, such examination and reports to be made and published at the same times and in the same manner and under the same conditions as required by the law of such State, Territory, or District in the case of incorporated banking institutions engaged in such business in the same locality."<sup>3</sup>

To extend compulsory reserve requirements to insured commercial banks, but not to other commercial banks, will provide an incentive to withdraw from deposit insurance, particularly in the case of banks which might feel that pressure was being put upon them to use their required balances at the Federal Reserve Banks as clearing accounts. It would also induce a reaction or feeling on the part of insured nonmember banks that they were unfairly being required to submit to additional conditions for insurance which had not been applied to them when they were admitted.

<sup>1</sup>This paper, in large part, is taken from a paper prepared last summer for the President's Committee on Financial Institutions. It presents personal opinions of the writer, and does not necessarily reflect views of the Federal Deposit Insurance Corporation.

<sup>2</sup>The Commission on Money and Credit recommended that this be accomplished by requiring all insured commercial banks to become members of the Federal Reserve System. The report of the Commission on Money and Credit, "Money and Credit, Their Influence on Jobs, Prices, and Growth" (Prentice-Hall, Inc., 1961), p. 77.

<sup>3</sup>Banking Act of 1933, sec. 21, as amended in 1935 and 1959, title 12 of the United States Code, sec. 378.

The number of noninsured commercial banks is now comparatively small. The extension of member bank reserve requirements to insured commercial banks would bring under such requirements 7,004 banks (as of December 31, 1961), while its extension to all banks with deposits used as circulating medium would bring in about 7,200 banks. A few insured commercial banks (27 on June 10, 1959) have no demand deposits and would be excluded if they are not members of the Federal Reserve System, and about 240 noninsured commercial banks would be included. A classification of commercial banks as of December 31, 1961, showing for noninsured banks those which it is presumed would be included or excluded, is as follows:

Total number of commercial banks and trust companies-----	13,444
Trust companies not regularly engaged in deposit banking (noninsured)	52
Commercial banks engaged in deposit banking-----	13,392
Members of the Federal Reserve System-----	6,111
Insured not members of the Federal Reserve System-----	7,004
Noninsured—total-----	277
<hr/>	
Presumably subject to proposed reserve requirements—total-----	240
Operating under general banking laws-----	141
Unincorporated banks-----	81
Cash depositories-----	4
Branches and offices of foreign banks-----	8
Government-owned banks-----	3
Banks operating under special charters-----	2
Cooperative exchange-----	1
<hr/>	
Presumably not subject to proposed reserve requirements—total-----	37
Industrial banks-----	34
Savings institutions operating under special charters (not mutual savings banks)-----	3

Under present law (title 12 of the United States Code, sec. 347c) a Federal Reserve bank, subject to regulations prescribed by the Board of Governors of the Federal Reserve System, may make advances to any nonmember bank on its promissory notes secured by direct obligations of the United States. Extension of the discount privileges of member banks to other banks with deposits used as circulating medium, without modification of section 347c, is recommended in order to make such privileges uniform for all commercial banks subject to the same reserve requirements as member banks.

CLARK WARBURTON.

DECEMBER 17, 1962.

PROPOSALS FOR CHANGE IN THE MEMBERSHIP AND TERMS OF OFFICE OF THE BOARD OF GOVERNORS OF THE FEDERAL RESERVE SYSTEM AND IN THE RELATION OF THE SYSTEM TO OTHER FINANCIAL AGENCIES OF THE FEDERAL GOVERNMENT

INTRODUCTION

Various proposals have been made for changes in the membership, and in the terms of office of members, of the Board of Governors of the Federal Reserve System. In many cases these proposals have accompanied proposed changes in the powers of the Board. To appraise the merit of such proposals it is essential to give consideration to the duties envisaged for the Board's operation in the future and to the degree and character of the relationship of the Board to the executive branch of the Government. Four basic questions regarding these duties and relationships are these:

1. Is the Board of Governors to continue to have the monetary responsibilities which it now claims, or additional powers also, with continuance of the present legislative instructions for their use; or is the Board to have such responsibilities with their execution guided by much more explicit legislative directives, such as those that have been suggested elsewhere?<sup>1</sup>

<sup>1</sup> For example, in my memorandum dated Nov. 6, 1962, "Guidelines for Federal Reserve Operations."

2. What are to be the Board's bank supervisory powers: (a) much as they are today; or (b) enlarged to include similar responsibilities with respect to most or all commercial banks, or at least most State-chartered commercial banks; or (c) narrowed by transfer of most of the Board's present bank supervisory powers to another agency?<sup>2</sup>

3. What is to be the relation of the Board of Governors of the Federal Reserve System to the President?

4. What is to be the relation of the Board to other agencies with bank regulatory powers, and to agencies concerned with other financial institutions?

#### RELATION OF THE LEGISLATIVE DIRECTIVE TO THE COMPOSITION OF THE BOARD OF GOVERNORS

If the Board of Governors is to retain its present monetary powers, or to be given also those of the Federal Open Market Committee, without a more explicit legislative directive regarding the character of its policies, then the Board needs to be comparatively large and might well be expanded to 12, or possibly more, members. This is because the present legislative guidelines are so vague and imprecise that the Board (together with the Federal Open Market Committee) is a basic policymaking body—i.e., a sort of legislative body to which the Congress has delegated some of its own policymaking duties.

If, on the other hand, the Congress exercises its legislative powers with respect to money in a manner that provides specific guidelines, then the Board of Governors will become, with respect to its monetary duties, primarily an administrative rather than policymaking body. In this situation the membership of the Board might well be reduced from seven to five or three members, or even replaced by a single administrator, provided the Board does not also have other broad responsibilities (such as its present bank supervisory duties).

#### BANK SUPERVISORY DUTIES AND COMPOSITION OF THE BOARD OF GOVERNORS

The present division of Federal Government bank supervision among three agencies has no counterpart in any other area of regulation of business enterprise. It can be understood only in terms of the historical development of governmental regulation of banking in the United States. In practice it works much better than might be expected from its illogical structure. Nevertheless, it gives rise to many frictional problems, and one of the tasks assigned to the President's Committee on Financial Institutions is formulation of recommendations regarding changes in the bank supervisory structure.

Persons concerned with the bank supervisory structure, both within and outside the Government, hold many different views and have made various types of suggestions for its modification. The point on which there seems to be the most agreement is that the Federal Reserve System should either be given much wider powers in the bank supervisory field or should be relieved of most of those which it now possesses. No comment is made here as to which is preferable, but it is clear that a decision regarding bank supervisory powers is an important factor in consideration of proposed changes in the composition of the Board of Governors. If the Board's present duties with respect to bank supervision are to be retained, and particularly if they are to be enlarged, it is desirable to have a Board with at least three members, even though the monetary powers of the Board were exercised under a specific legislative directive. Decisions with respect to bank holding companies, mergers, and some other aspects of bank supervision, are of the sort that in other areas of business regulation are entrusted to commissions.

#### RELATION OF THE BOARD OF GOVERNORS TO THE PRESIDENT

Proper administration of monetary policy is of such vital importance to national welfare and to the success of other Government policies that it should be a responsibility of a top-ranking official, and should be appropriately coordinated with the executive branch of the Government. Consequently, serious consideration should be given to the proposal that is sometimes made that the exercise of monetary power be lodged in one of the executive departments, and therefore become the responsibility of a member of the President's Cabinet. However, such a shift in the location of monetary policy administration should

<sup>2</sup> As has been suggested, for example, by Governor Robertson.

not be made without provision by the Congress of a suitably detailed directive for monetary policy. To do so would give an executive agency and the President powers of a legislative character so broad that they would probably be unconstitutional under the decision of the Supreme Court in the *Schechter* case.

If and when the Congress adopts a suitably detailed directive for monetary policy, it might be considered appropriate to place its execution in the Department of the Treasury, either directly or by making the Board of Governors of the Federal Reserve System a part of the Treasury. In many countries regulation of banking and the execution of monetary policy, including, directly or indirectly, the management of the central bank, is a duty of the Finance Minister. My own opinion is that this would not be a good procedure, for reasons which I set forth some years ago:

It is well known that a very large proportion of the great errors in monetary policy which have been made by various nations, and have led to atrocious injustices, spoliation of large classes of the population, and profound economic disturbances, have resulted from too great a subordination of monetary and banking policy to the apparent needs of the Government Treasury. It may be true that in wartime and in other great emergencies it is necessary to bend monetary policy to the needs of the Government Treasury; but it is also true that too much subordination of monetary policy, too cheap and easy borrowing by the Government, has been one of the frequently repeated and extremely calamitous errors of government policy both in the United States and in almost all other nations in the world.

It would be a disastrous mistake for the administration of monetary policy, or the supervision of banks and other financial institutions, or control of Government lending agencies to be vested in the official who is responsible for handling the revenue, expenditures, and debt of the Federal Government itself. Similarly, it would be a mistake for the policies of the banking and lending agencies to be dominated by a council subject to probable domination by the Secretary of the Treasury. The policies of the monetary and credit institutions of the Nation must necessarily give adequate consideration to the needs of borrowers, including the needs of the Government itself; but only tragedy can result from control of the Nation's credit institutions by the borrowing officer of the largest concern needing to borrow, even though that concern is the Government itself.

The foregoing comments do not mean that monetary policy should rest outside of the Federal Government, nor that it should be exercised by an official or group of officials in an agency of subordinate rank. Issue of money or circulating medium and regulation of its value is one of the basic responsibilities placed in the Federal Government by the Constitution. Administration of monetary policy is of vital importance to national welfare and should be the responsibility of a top-ranking official who does not have other responsibilities likely to conflict with the best monetary policy. Similarly, healthy functioning of the Nation's credit institutions is important to the welfare of the country and achievement of the purpose of the Employment Act of 1946. It is appropriate that basic governmental decisions regarding the policies and operations of loan institutions should be made or coordinated by an official of Cabinet rank, but responsibility for such decisions should not be placed in the Cabinet officer who directs the finances of the Federal Government itself.<sup>3</sup>

Another method of placing the administration of monetary policy, under a suitable legislative directive, in the executive branch of the Government would be to consider the Chairman of the Board of Governors a member of the President's Cabinet, to be appointed in the same way as other department heads so that the Board of Governors and its employees would in effect comprise another department. The proposals of the Commission on Money and Credit for making the terms of the Chairman and Vice Chairman coterminous with that of the President, changing the number and tenure of members of the Board so that the President would make one appointment shortly after his inauguration, with transfer of the powers of the Federal Open Market Committee to the Board, would be a step toward such an administrative arrangement.<sup>4</sup> Consideration

<sup>3</sup> Clark Warburton, "Coordination of Monetary, Bank Supervisory, and Loan Agencies of the Federal Government," *Journal of Finance*, V (June 1950), pp. 160-161.

<sup>4</sup> The report of the Commission on Money and Credit, "Money and Credit, Their Influence on Jobs, Prices, and Growth" (Prentice-Hall, Inc., 1961), pp. 91-93. A modification of the Commission's proposals might be necessary to make it clear that the President could make his new appointee the Chairman of the Board.



of this possibility raises other questions, particularly the place in the executive branch of other agencies which have regulatory and other duties with respect to banks, credit (loan) policies, and other financial enterprises.

RELATION OF THE BOARD OF GOVERNORS TO OTHER FINANCIAL AGENCIES OF THE  
FEDERAL GOVERNMENT

Another aspect of the Federal Government structure pertinent to consideration of the relation of the Federal Reserve System and other financial agencies to executive departments is the fact that in no other area of Government are there so many separate agencies reporting directly to the President or only to the Congress.

Eight of the 43 organizations listed as independent agencies in both the U.S. Government Organization Manual and the Congressional Directory are agencies dealing primarily with monetary or credit (loan) policies, the making of loans, or regulation of financial institutions. These are as follows:

- Export-Import Bank of Washington.
- Farm Credit Administration.
- Federal Deposit Insurance Corporation.
- Federal Home Loan Bank Board.
- Federal Reserve System (or its Board of Governors).
- Housing and Home Finance Agency.
- Securities and Exchange Commission.
- Small Business Administration.

In addition, the Office of the Comptroller of the Currency, in the Treasury Department, and the Bureau of Credit Unions, in the Department of Health, Education, and Welfare, deal with financial institutions in a manner essentially similar to that of some of the foregoing independent agencies.

Special committees appointed by the President to consider changes in the administrative organization of the Government have made various recommendations regarding the relation of these agencies, or their predecessors, to each other and to the President. Those recommendations, for the most part, are of two sorts: that some or most of the financial agencies be assigned to one of the departments; or that their activities be coordinated through a National Monetary and Credit Council.

RECOMMENDATIONS OF THE PRESIDENT'S COMMITTEE ON ADMINISTRATIVE  
MANAGEMENT (1937)

The President's Committee on Administrative Management in 1937 recommended that all agencies supervising business or governmental corporations be placed in appropriate departments, with such agencies given semiautonomous status when it is desirable to preserve the independence of the agency. The Committee did not name the department to which the monetary, banking, and loan agencies should be assigned, but its description of the major purposes of the recommended departments implied their placement in the Department of the Treasury.<sup>5</sup>

RECOMMENDATIONS OF THE FIRST COMMISSION ON ORGANIZATION OF THE EXECUTIVE  
BRANCH OF THE GOVERNMENT (1949)

Two of the eight independent agencies listed above—the Board of Governors of the Federal Reserve System and the Securities and Exchange Commission—were classified (with seven other agencies) as independent regulatory commissions by the first Commission on Organization of the Executive Branch of the Government, which reported in 1949. The Commission did not recommend placing the independent regulatory commissions in the departments, but did recommend that the membership of all such commissions be required to be bipartisan, that all administrative responsibility be vested in the chairman of the commission, and that purely executive functions be transferred to the appropriate department (with specifications for some of the commissions but not for the Board of Governors of the Federal Reserve System nor the Securities and Exchange Commission).<sup>6</sup> In addition, recommendations regarding the regulatory

<sup>5</sup> "Administrative Management," report of the President's Committee, 1937, pp. 35, 36, and 45.

<sup>6</sup> "The Independent Regulatory Commissions," a report to the Congress by the Commission on Organization of the Executive Branch of the Government, March 1949, p. 5.

commissions were made by the Commission's task force on regulatory agencies, which the Commission hoped would be given thorough study and consideration by the Congress.

The chief recommendations of the Commission's task force on regulatory agencies applicable to the Board of Governors of the Federal Reserve System were: (1) that the Chairman should be designated from among the members by the President and should serve as Chairman at his pleasure; (2) that all Federal Reserve policymaking powers be consolidated in a new, smaller Board of Governors; (3) that the Board of Governors be reduced in size to three members, each term to run for 6 years, with reappointments permitted; (4) that consideration be given to the possibility of combining all Federal bank supervisory agencies in one agency, and suggesting the Federal Reserve as the most promising locus for such a consolidation; and (5) that power to determine margin requirements for loans on securities be transferred from the Board of Governors to the Securities and Exchange Commission, with retention by the Board of an overriding power if proposed or existing standards would materially prejudice the general credit structure of the country.<sup>7</sup>

The Commission's task force on regulatory agencies also showed great concern about coordination of monetary policy with Treasury fiscal policy and with policies of lending agencies. With respect to the relation of monetary and fiscal policy is stated:

"In our economy today, control of the money supply \* \* \* cannot be realistically viewed apart from Government fiscal and debt policy \* \* \*.

"Given the present Federal Reserve price-support policies on outstanding Government securities, decisions on the interest rate structure paid on Treasury offerings are in effect the crucial decisions governing monetary policy \* \* \*.

"\* \* \* the Government (the Executive and Congress) will not, and should not, tolerate obstructionist action by the central bank against Government policies. A truly independent central bank, free to control the Nation's money supply counter to the wishes of the President and Congress, is unrealistic in the modern world \* \* \*.

"\* \* \* Today the Federal Reserve is by law completely independent of the Treasury and only indirectly responsible to the President through his appointments of Federal Reserve Board members and designation of the Chairman. Yet, as a practical matter, on virtually every major issue where Federal Reserve-Treasury differences have arisen, the Federal Reserve has gone along with the Treasury—for example, in the handling of wartime and postwar Government financing. The reason is that the Federal Reserve officials, as responsible Government servants, would never be willing to flatly disrupt or destroy the Government's fiscal policy on important matters. Ultimately, the central banks must go along, whatever its formal legal status; and ultimately it is the Chief Executive, who, within the limits imposed by Congress, establishes the Government's monetary-fiscal policy. The Secretary of the Treasury almost invariably is an intimate adviser of the President. By his very semi-isolated legal status, the Chairman of the Federal Reserve Board almost certainly will not be.

In practice, therefore, there exists no serious problem of lack of coordination between monetary and fiscal policy. The two are coordinated, but almost invariably in a policy advocated by the Treasury, subject to varying degrees of Federal Reserve influence. This experience suggests that means must be found to give a more equal voice to the central bank in the process of Government policy formation."<sup>8</sup>

With regard to the relation of monetary policy and lending policy the task force commented:

"No formal or informal mechanism exists to assure coordination between Federal Reserve monetary policy and the policies of the many Government lending agencies. Important conflicts have often developed \* \* \*. Better cross-information and coordination in the formation of the Government monetary and lending policies is necessary."<sup>9</sup>

To handle these two problems of coordination, the task force on regulatory agencies recommended a formal or informal national monetary council, consisting of the Secretary of the Treasury, Director of the Bureau of the Budget,

<sup>7</sup> "Task Force Report on Regulatory Commissions" (app. N), prepared for the Commission on Organization of the Executive Branch of the Government, January 1949, pp. 81, 113, 114, 116-117, and 150.

<sup>8</sup> *Ibid.*, pp. 109-110.

<sup>9</sup> *Ibid.*, pp. 110-111.

Chairman of the Board of Governors of the Federal Reserve System, and a representative of the lending agencies (augmented at times by other officials, such as the Chairman of the Securities and Exchange Commission, when dealing with inflation control problems). The task force suggested that the existing National Advisory Council on International Affairs might be consolidated with such a Council. The Chairman of the Council would be selected by the President. The task force envisaged the Council as an advisory council, with the four officials speaking with roughly equal status, and with no power of directive over the participating agencies.<sup>10</sup>

Another task force of the Commission, that on lending agencies, proposed a similar advisory council for formulation of fiscal policies and coordination of the policies of fiscal, monetary, and lending agencies. It recommended establishment of a National Monetary and Credit Council with the members listed below. This Council would operate in both domestic and international affairs, without authority to issue directives to, or veto operating decisions made by, the agencies.

Secretary of the Treasury, Chairman.

Chairman of the Board of Governors of the Federal Reserve System, Vice Chairman.

Chairman of the Farm Credit Board (to be established).

Chairman of the Board of Directors of Export-Import Bank of Washington.

Chairman of the Home Loan Bank Board.

Chairman of the Board of Directors of Federal Deposit Insurance Corporation (if continued as a separate agency).

Chairman of the Board of Directors of Reconstruction Finance Corporation (if continued in existence).<sup>11</sup>

The task force on lending agencies also recommended changes in status or organization of the agencies dealing with agricultural and home financing and with deposit insurance. It recommended (1) that the Farm Credit Administration be separated therefrom and become an independent Farm Credit Board; (2) that the Federal Home Loan Bank Board, then a constituent agency of the Housing and Home Finance Agency, include the components of the latter agency except the Public Housing Administration and that the Housing and Home Finance Agency be discontinued; (3) that the Farm Credit Board and the Federal Home Loan Bank Board might be organized as to appointments and tenure in the manner of the Board of Governors of the Federal Reserve System; and (4) that the Federal Deposit Insurance Corporation be designated an instrumentality of the Federal Reserve System and placed under the supervision of the Board of Governors. The task force on lending agencies indicated that it would also recommend placing the Office of the Comptroller of the Currency, if that agency were included within its scope of study, under the supervision of the Board of Governors.<sup>12</sup>

Another task force, in a report on fiscal, budgeting, and accounting activities, stated that the Comptroller of the Currency more properly belongs under the Board of Governors of the Federal Reserve System than in the Treasury Department. It noted, however, that the national banks had become accustomed to deal directly with the Treasury through the Comptroller of the Currency and were understood to prefer that arrangement, and that little or no economy would result from moving the office elsewhere; and recommended that the office, if continued in the Treasury, be placed under an Assistant Secretary in charge of Banking and International Finance.<sup>13</sup>

The Commission on Organization of the Executive Branch of the Government, in its report on the Treasury Department and in its concluding report, agreed in part and disagreed in part with the foregoing recommendations of its task force on lending agencies. It recommended (1) placing the Federal Deposit Insurance Corporation, Export-Import Bank, and Reconstruction Finance Corporation, under the supervision of the Secretary of the Treasury; (2) retention of the Farm Credit Administration in the Department of Agriculture, in the

<sup>10</sup> *Ibid.*, pp. 111-112.

<sup>11</sup> "Task Force Report on Lending Agencies" (app. R), prepared for the Commission on Organization of the Executive Branch of the Government, January 1949, p. xii.

<sup>12</sup> *Ibid.*, pp. 33-34, 46, 52-53, 64-65.

<sup>13</sup> "Task Force Report on Fiscal, Budgeting, and Accounting Activities" (app. F), prepared for the Commission on Organization of the Executive Branch of the Government, January 1949, pp. 18-19.

form of an "Agricultural Credit Service"; (3) retention of the Housing and Home Finance Agency, with reorganization of some of its components and transfer to that Agency of some functions located elsewhere (e.g., home loan guarantee functions of the Veterans' Administration); and (4) establishment of a National Monetary and Credit Council. The Council would advise on policies and coordination of the operations of domestic lending and Government financial guarantees. It would consist of representatives appointed by the President from such agencies as the Board of Governors of the Federal Reserve System, the Housing and Home Finance Agency, the Farm Credit Administration, the Reconstruction Finance Corporation, and others as the President may determine, with an Assistant Secretary of the Treasury serving as secretary of the Council.<sup>14</sup>

RECOMMENDATIONS OF THE SECOND COMMISSION ON ORGANIZATION OF THE EXECUTIVE BRANCH OF THE GOVERNMENT (1955)

The second Commission on Organization of the Executive Branch of the Government and its task forces, which reported in 1955, made recommendations regarding monetary, credit, and lending agencies which differed from those of the first Commission. It did not recommend placing any of the independent financial agencies in a department, and did not recommend establishment of an advisory council to coordinate their activities.

The second Commission recommended (1) that the Export-Import Bank be reorganized or liquidated;<sup>15</sup> (2) that the Small Business Administration, which had been established in 1953 at the time the Reconstruction Finance Corporation was placed in liquidation and was scheduled to expire at the end of June 1955, be continued for 2 years and given an opportunity to test its usefulness; and (3) that the Home Loan Bank System, which was then a component of the Housing and Home Finance Agency, be given independent status similar to that of the Federal Reserve System (presented as an alternative to rescinding authority, insofar as the Home Loan Bank System was concerned, given in 1955 to the Administrator of the Housing and Home Finance Agency to transfer functions and funds among the constituent components of that agency).<sup>16</sup> In addition, the second Commission recommended that a representative of the Secretary of the Treasury sit *ex officio* on all boards or commissions having the power to affect the fiscal policy of the United States. Though a list of such boards and commissions was not given, this recommendation presumably applied to all of the independent financial agencies, since its purpose was to provide a mechanism whereby the financial policies of the various lending, guaranteeing, and insurance agencies, including the Federal Reserve System, would be coordinated with the credit policies of the Department the Treasury.<sup>17</sup>

In some respects these recommendations of the second Commission differed from those of its task force on lending agencies. The task force had recommended (1) that the Housing and Home Finance Agency, be discontinued and its components divided into three separate establishments—the Federal Home Loan Bank System, the Federal Housing Administration as a mortgage-insurance system, and a slum clearance and urban renewal program including the Public Housing Administration; and (2) that both the Small Business Administration and the Export-Import Bank be discontinued and their lending activities eliminated.<sup>18</sup>

<sup>14</sup> "Treasury Department," a report to the Congress by the Commission on Organization of the Executive Branch of the Government, March 1949, pp. 10-12 and 19-21; concluding report, a report to the Congress by the Commission on Organization of the Executive Branch of the Government, May 1949, pp. 61, 62-63, and 71-72.

<sup>15</sup> In fact the Commission made the conflicting recommendations (a) that the Export-Import Bank cease normal commercial short-term import-export loans and be set up as the sole Federal instrumentality for making long-term export loans, loans for development of foreign resources, and loans to foreign governments, and (b) that it be liquidated. "Lending, Guaranteeing, and Insurance Activities," a report to the Congress by the Commission on Organization of the Executive Branch of the Government, March 1955, pp. 84 and 108-109.

<sup>16</sup> *Ibid.*, p. 23.

<sup>17</sup> *Ibid.*, p. 110.

<sup>18</sup> "Task Force Report on Lending Agencies," prepared for the Commission on Organization of the Executive Branch of the Government, February 1955, pp. 31 and 71.

## A SUGGESTION FOR GROUPING FINANCIAL AGENCIES IN A NEW DEPARTMENT

Very few of the recommendations, mentioned above, of special Presidential committees, regarding monetary, credit, and lending agencies have been accepted by the Congress. Only two of the financial agencies mentioned have been placed in a department; and of these, one has been liquidated and the other returned to independent status. The Reconstruction Finance Corporation was placed in the Treasury for liquidation, but with an independent successor agency (Small Business Administration) to continue one phase of its activities. The Farm Credit Administration, an independent agency prior to 1939, was in that year placed in the Department of Agriculture, but was again made an independent agency in 1953. The Housing and Home Finance Agency, which was formed in 1947 to include several previously independent agencies, was separated into two parts in 1955, when the Federal Home Loan Bank Board again became a separate independent agency.

The proposed national monetary and credit council, to coordinate the activities of the financial agencies, has not been established. However, the need for such coordination, and the difficulties of its accomplishment under present arrangements, are as great—in fact, they have become intensified. Also, the need for a representative of the central bank and lending agencies among the President's advisers, of equal rank with the Secretary of the Treasury, has not diminished. The suggestion is therefore offered here that the Congress consider a new approach to coordination of the policies of the Government's financial agencies, that of grouping those agencies in a new department headed by a coordinator.

There would be many advantages in grouping in a new department all of the banking agencies and the other financial agencies not attached to one of the existing departments. Real and potential conflicts of policy, of which there are many, could be more readily solved. In addition, there is need for an executive agency that would have the responsibility of looking at the manifold credit problems of the Nation as a whole. But many thorny, perhaps insuperable, problems would be encountered in such a grouping into a department in which the powers and responsibilities of the various agencies would be assigned to the Secretary of the department.

Moreover, many of the advantages of such a grouping could be obtained by making the head of a department embracing financial agencies a coordinating official, with the boards or heads of the various agencies retaining their powers. A good coordinator, without power to overrule the actions of any of the agencies, would be able, over a period of time, to achieve a great deal with such problems as that of reconciling the present vastly divergent views and procedures in the area of examination and supervision of commercial banks, mutual savings banks, and savings and loan associations. Such a coordinator would also be in a position to make, from time to time, recommendations regarding reorganization or shifting of duties among the various agencies—either to the Congress for legislation or to the President for action under his powers relating to organization of executive agencies. A tentative draft of a bill providing for a Department of Financial Affairs is attached.

Such an arrangement will not, of course, solve any of the manifold problems relating to banking and credit and to the operations of the banking, credit, and lending agencies which have aroused much discussion with expressions of widely divergent views. However, problems which now cause many interagency conferences, including those with which the President's Committee on Financial Institutions has been dealing, would become problems of intradepartmental conferences, with a permanent official acquainted with the operations and problems of all the agencies to act as chairman. The coordinator, through such conferences, would be able to handle many of the problems which the 1949 Commission on Organization of the Executive Branch of the Government and its task forces on regulatory commissions and on lending agencies thought required establishment of a formal or informal national monetary council, and which led the task force on lending agencies of the 1955 Commission to recommend establishment of a National Monetary and Credit Council. The position of the coordinator as a member of the President's Cabinet would give the central bank, together with the lending agencies, an equal voice with the Secretary of the Treasury in the coordination of monetary and fiscal policy, which the task force on regulatory commissions of the 1949 Commission regarded as essential.

## TERMS OF OFFICE OF MEMBERS OF THE BOARD OF GOVERNORS

The 14-year terms of office of members of the Board of Governors of the Federal Reserve System are much longer than those of members of other regulatory commissions, which range from 5 to 7 years.<sup>19</sup> The Comptroller of the Currency and the members of the Board of Directors of the Federal Deposit Insurance Corporation have 5- and 6-year terms, respectively. The apparent reason for specifying such long terms for members of the Federal Reserve Board, when it was originally established—to insulate the Board from considerations affecting current Government policies—now seems anachronistic. It is suggested that the term of office of members of the Board of Governors be made similar to those for members of other commissions and banking agencies.

**A BILL** To establish a Department of Financial Affairs in the executive branch of the Government

*Be it enacted by the Senate and House of Representatives of the United States of America in Congress assembled,* There shall be an executive department in the Government to be called the Department of Financial Affairs, with a Coordinator of Financial Affairs, who shall be the head thereof, to be appointed by the President, by and with the advice and consent of the Senate, and whose tenure of office shall be like that of the heads of the other departments. The provisions of sections 1-9, 22, 23-25, 33, 38, 43, 44, 48, 49, 51, 91, 93, 94, 95, 96, 99, 104, and 106 of title 5 of the United States Code shall be applicable to said Department.<sup>20</sup> The said Coordinator shall cause a seal of office to be made for the said Department of such device as the President shall approve and judicial notice shall be taken of the said seal.

SEC. 2. There is established in the Department of Financial Affairs an Office of Assistant Coordinator of Financial Affairs, which shall be filled by appointment by the President, by and with the advice and consent of the Senate. The Assistant Coordinator of Financial Affairs shall perform such duties as may be prescribed by the Coordinator of Financial Affairs or required by law. The Assistant Coordinator shall (1) in case of the death, resignation, or removal from office of the Coordinator, perform the duties of the Coordinator, until a successor is appointed, and (2) in the case of the absence or sickness of the Coordinator, perform the duties of the Coordinator until such absence or sickness shall terminate.

SEC. 3. The salaries of the Coordinator and Assistant Coordinator shall be the same as those, respectively, of the Secretaries and Assistant Secretaries of other executive departments.

SEC. 4. There shall be in the Office of the Coordinator of Financial Affairs a chief clerk and such other professional and clerical assistants as may from time to time be provided for by Congress or appointed by the Coordinator to enable him to carry out his duties under this Act.<sup>21</sup>

SEC. 5. The following hitherto "independent agencies" shall hereafter be component parts of the Department of Financial Affairs: Export-Import Bank of Washington; Farm Credit Administration; Federal Deposit Insurance Corporation; Federal Home Loan Bank Board; Federal Reserve System; Housing and Home Finance Agency; Securities and Exchange Commission; and Small Business Administration.

SEC. 6. (a) The Bureau of the Comptroller of the Currency, with its personnel, property, record, and unexpended balances of appropriations, is hereby transferred from the Department of the Treasury to the Department of Financial Affairs, and the Coordinator of Financial Affairs shall exercise the duties relating to said Bureau hitherto vested by law in the Secretary of the Treasury.

(b) The Bureau of Federal Credit Unions, with its personnel, property, records, and unexpended balances of appropriations, is hereby transferred from the Department of Health, Education, and Welfare to the Department of Financial Affairs, and the Coordinator of Financial Affairs shall exercise the duties relating to said Bureau hitherto vested by law in the Secretary of Health, Education, and Welfare.

<sup>19</sup> "Task Force Report on Regulatory Commissions" (App. N), prepared for the Commission on Organization of the Executive Branch of the Government, January 1949, p. 13.

<sup>20</sup> This sentence is based on provisions relating to the Departments of Commerce and of Labor. No attempt has been made here to review the specified sections to verify their applicability to a new Department of Financial Affairs.

<sup>21</sup> Additional provisions regarding employees in the office of the Coordinator, and regarding premises that may be occupied, may be desirable.

(c) This section of this Act shall become effective on the day the Coordinator of Financial Affairs takes the oath of office.

SEC. 7. The Coordinator of Financial Affairs shall use his influence to coordinate the policies of, and avoid duplication of work by, the agencies and bureaus in the Department of Financial Affairs, and to assist those agencies and bureaus in performing their duties in the most effective manner. He shall, from time to time, establish such temporary or permanent committees, consisting of representatives of all or part of said agencies and bureaus, as he may deem desirable, and shall serve as chairman or designate the chairman of such committees.

SEC. 8. The Coordinator of Financial Affairs, in order to keep himself informed of the decisions and actions, and reasons therefor, of the component agencies in the Department of Financial Affairs, may attend as an observer any meeting of the governing board of any of those agencies. Each such governing board shall transmit to the Coordinator the minutes of each of its meetings, and the head of each of the other agencies or bureaus in the Department shall provide the Coordinator with written reports on all major decisions and actions and the reasons therefor.

SEC. 9. (a) The Coordinator of Financial Affairs shall make such studies and prepare such reports as he may deem desirable on the lending activities of the agencies and bureaus in the Department and of the institutions supervised by such agencies and bureaus. In such studies and reports he shall give attention to the appropriate aims of Government control over the terms and amounts of loans made in the economy and over the operations of financial institutions, including the following: that of assuring ample provision for credit in all segments of the economy where loans are needed; that of establishing conditions such that particular individuals or other borrowers are unlikely to exceed reasonable limits in the credit obligations that they undertake; and that of minimizing unduly risky or unsound practices of financial institutions.

(b) The Coordinator of Financial Affairs shall make such studies and prepare such reports as he may deem desirable on the relation of monetary policy and of the policies of lending agencies and institutions to the maintenance of maximum employment, production, purchasing power, and stability of the value of money, and to fiscal policies of the Government directed thereto.

SEC. 10. The Coordinator of Financial Affairs shall, at such times as he deems desirable, transmit to the Congress and the President such recommendations as he deems desirable for changes in legislation applicable to any of the agencies or bureaus in the Department of Financial Affairs; and shall recommend to the President such actions as he may deem desirable under the President's powers of reorganization of Government departments and agencies.

SEC. 11. The Coordinator of Financial Affairs shall annually, as soon after the close of each fiscal year as is feasible, make a report in writing to Congress, giving an account of all moneys received and disbursed by him, and summaries of all moneys received and disbursed during the preceding calendar year, or fiscal year, by each of the agencies and bureaus in the Department of Financial Affairs. He shall also, from time to time, make such special investigations and reports as may be required by the President, or by Congress, or which he himself may deem necessary.

SEC. 12. There is authorized to be appropriated, out of any money in the Treasury not otherwise appropriated, for the expenses of the Office of the Coordinator of Financial Affairs, a sum not to exceed \$1,000,000 annually.

SEC. 13. If any provision of this Act, or the application thereof to any person or circumstances, is held invalid, the remainder of the Act, and the application of such provision to other persons or circumstances, shall not be affected thereby.

SEC. 14. This Act may be cited as the Financial Affairs Act of 196-, and shall constitute chapter 11D of title 5 of the United States Code, to be inserted immediately after chapter 11C thereof.

CLARK WARBURTON.

DECEMBER 13, 1962.

The CHAIRMAN. Mr. Reuss, would you like to interrogate the witness?

Mr. REUSS. Thank you, Mr. Chairman. Dr. Warburton, your last words were "if the subcommittee wishes I shall be glad to prepare a paper on the payment of demand deposits." As far as I am concerned, the subcommittee does wish it.

The CHAIRMAN. Yes. If you will prepare that we will insert it at this point in your testimony.

(The information referred to above was not available at time of this printing.)

Mr. REUSS. I congratulate both of you gentlemen on a really historic contribution to learning and thinking about the Federal Reserve System.

And while you prepared your papers, I gathered entirely independently—

Mr. WARBURTON. Yes.

Mr. REUSS. Your conclusions are certainly pointing in the same direction, although Dr. Warburton goes into detail much more than Professor Gurley does.

Professor Gurley, can you state your money-creating proposition as a formula or as a legislative directive? You seem to have worked out a relationship whereby near money; that is, time deposits, gets a value of 50 percent, something like that.

Mr. GURLEY. That is right, yes, sir, Mr. Reuss.

Mr. REUSS. Would you make a stab at stating the law according to Gurley?

Mr. GURLEY. One would think as a beginning proposition that, in order to hold interest rates stable, the money supply should increase by approximately the same percentage as gross national product. We have heard it stated many times that if gross national product grows by 5 or 6 percent this year, then the money supply should grow by 5 or 6 percent. Now what I am saying is that this relationship depends upon the growth of near moneys, time deposits, savings and loan shares, and mutual savings deposits especially, and upon the growth of total debt in the economy, where total debt includes corporation bonds, mortgages, State and local government securities, Federal Government securities, consumer installment debt and business loans, short, medium, and long, from commercial banks, et cetera.

The proposition is that if the near moneys grow at a faster rate than total debt, then the money supply need not grow as fast as gross national product.

Or if you wish to focus upon the stability of interest rates, as I have, the proposition is that if other forms of liquidity grow very rapidly in the economy relatively to total debt, that the monetary liquidity, that is the money supply, need not grow so rapidly to keep interest rates stable from one year to the next.

I have just one thing to add to that—

Mr. REUSS. May I interrupt at this point?

Mr. GURLEY. Yes.

Mr. REUSS. To summarize what you have said so far. Are you saying, then, that we should pick a projected rate of desirable growth of the GNP, let's say 5 percent a year, and accordingly produce a money supply which grows at 5 percent a year, counting demand deposits and currency outside banks as the regular money supply.

If you can't get a 5-percent increase out of that, you have to supplement it with the surplus increase of near money over the increase in the national debt divided by 2—weighed at one-half.

Mr. GURLEY. Yes. There is just one correction. It is not increase in national debt but the increase in total debt.

Mr. REUSS. Increase in total debt?

Mr. GURLEY. Yes; that is correct.



Mr. Reuss, may I point out table 2. I referred to these figures in the statement but I did it very briefly. You see, if you look at the growth rates of the things we have just been talking about, in 1960 to 1961, 1961 to 1962, and 1962 to 1963, interest rates have remained fairly stable, both long-term and short-term interest rates, and yet as you can see, the money supply has grown by just about half the rate of GNP. For example, from 1962 to 1963 the money supply grew by 3.1 percent, GNP by 5.4 percent. Yet interest rates remained stable because other liquidity grew at a much faster pace than total debt, as shown in columns 3 and 4 of that table.

Now, the question is for this current year whether other liquidity is going to continue to grow as rapidly as it has in the past. My conclusion is that it is not, that there were special factors making for the very rapid growth of liquidity in the last 2 years, that it is going to slump down somewhat, which means that we need a slightly larger increase in money supply growth than we have had in the past year or so.

I assume about 4 percent. I conclude a 4-percent rate of growth in the money supply is needed to achieve this rather limited objective of stability in interest rates.

Mr. REUSS. Both of you gentlemen tended to shrug off the international implications of a given rate of increase in the money supply and its effect upon the interest rate.

Dr. Warburton says that the adoption of a set of legislative canons for the increase in the money supply would reassure foreign holders of dollar deposits and keep them from demanding gold.

As both of you gentlemen undoubtedly know, the Joint Economic Committee has for some years been advocating a new international monetary mechanism which would, to a very large degree, insulate and seal off one country like this one against the effects of short-term capital movements that are produced by varying interest rates.

The Joint Economic Committee has thought that was very necessary.

If you had such a new international monetary mechanism, I would agree with you gentlemen that your money-creating formula, which has a very direct effect on interest rates, could be formulated substantially without reference to international monetary matters. But do you really think, as your papers seem to imply, that we could, absent such an improved monetary mechanism, be quite as unconcerned as you would seem to be about international monetary implications? Would you both answer that question. Dr. Warburton.

Dr. WARBURTON. I would expect that we would need some modification of our arrangements with other countries regarding the international medium of exchange and the International Monetary Fund.

I am not sure that that is absolutely necessary, but as time goes on, it would doubtless become more and more essential. I am not prepared, however, to make specific proposals along that line.

Mr. REUSS. Before Professor Gurley answers, my difficulty with the formulas that you gentlemen are advancing, in the absence of a new and improved international monetary mechanism, is that while the case hasn't really been proved as to just how sensitive short-term capital is to interest rate variations between various countries, we all I think would have to agree that capital does flit around from one country to another, and unless you have something to take the rough

edges off convertibility and see that it doesn't bankrupt the country which is trying to keep its domestic money supply up and interest rates low, you run into some difficulties. I would think to ask you the same question, Professor Gurley.

Mr. GURLEY. Yes; I have concern with the international balance-of-payments position.

My objective, as I outlined it in the paper, was to hold interest rates fairly constant this year, that is to hold them at the average that they were last year, and this is out of concern with the international balance of payments. If it were not for the balance-of-payments difficulties I would certainly go a whole lot further than that. I would then like to see the money supply increased by 5 or 6 percent this year, and risk a little bit of price inflation in order to get the economy back to a full employment level.

Mr. REUSS. Without wishing to argue the point with you too much, I suggest that while up until now you have been very pleasantly flexible and unmechanical in your formulation, what you have just said sounds a little mechanical to me. That is to say, you don't know really the amount of our balance of payments difficulties before hand, and you don't know, for example, nor can any of us tell what the central banks in Germany, France, and Italy are going to do about their domestic interest rates.

Therefore, I put it to you that really what is needed to encrust itself around your formulas for increasing the domestic monetary supply, is some kind of a new international monetary mechanism which will to a very large extent isolate ourselves against what foreigners choose to do about their money supply, about their own interest rates. Would you agree?

Mr. GURLEY. Yes; I agree with that, Mr. Reuss. I didn't want to sound mechanical. There is always something mechanical, you know, behind a fairly definite statement. One has to look at figures and see relationships between different things, and either do this in a very precise statistical way or else form a rather rough judgment about these things.

Mr. REUSS. I think this is the great contribution that both of you gentlemen have made this morning, in that you have suggested in a tactful way that the congressional guidelines that Congress thinks it is suspending before the money managers are absurd, that if they ever had any significance they have long since lost that significance, and that it is high time that Congress did its constitutional job and set forth guidelines for the money managers so they know what they are supposed to do, and don't have to go on a frolic of their own where they invent their own guidelines, frequently after they have acted.

My time is up but I want to express my gratitude again.

The CHAIRMAN. Mr. Widnall?

Mr. WIDNALL. No questions.

The CHAIRMAN. Mr. Hanna?

Mr. HANNA. Thank you, Mr. Chairman. Professor Warburton, you indicated under the arrangement of setting up a separate department in the executive, without the guidelines that you talked about might be an unconstitutional delegation of power according to the *Schechter* case. Why is it that the present delegation to the Federal Reserve never has been challenged on these grounds?

Mr. WARBURTON. I suppose for historical reasons. When the Federal Reserve System was established, there were limits to what they could do because of adherence to the gold standard and other traditions of the times. And it was probably not realized that the Board and banks were given such broad powers as were given to them. I think it is possible that a very good case could be made that they now have powers which, if surveyed in the light of the *Schechter* case decision, would be held unconstitutional.

Mr. HANNA. Then you have answered the second question, the one I had that would immediately follow on that. Assuming that the Federal Reserve has actual powers as recited by Mr. Balderson in the footnote to the comment that you make, would you think that a good case could be made under the *Schechter* rule that such broad powers delegated without clear guidelines might very well be held to be within the rules set down in the *Schechter* case?

Mr. WARBURTON. I think a good case can be made for that. I would not express any opinion as to what decision would be made by the courts.

Mr. HANNA. I noted in your talking, Professor Gurley, about the relationship between GNP and the money supply, that you have very quickly grasped the significance of the change that we have made on our time deposits and these certificate deposits which are very freely negotiable. I think we had testimony the other day, Mr. Chairman, that after having this innovation created, that there was a substantial shift from demand deposits into time deposits, because of the ready liquidity that was created by these CD's, and I think the testimony was that the time deposits changed from some few hundred millions to \$12 billion today, so that there is a very significant recognition I think in the financial world as to what can be done here, and I was rather impressed by the fact that maybe the question about how to define the money as such might very well be left with this division in terms of technical money and what we mean in total liquidity.

That is the time of approach your formula takes, is it not, Professor Gurley?

Mr. GURLEY. Yes. It defines money in the conventional Federal Reserve way of demand deposits and currency, those two components making up the money supply. Then the other liquidity is composed of the time deposits, savings and loan shares and mutual savings deposits. As Mr. Reuss pointed out a few moments ago, what I found was that the degree of substitution between the money supply and these other forms of money is about one-half. That is, for example, when the negotiable certificates of deposit increased by let's say \$5 billion in 1 year, that reduced the amount of money people wished to hold by just one-half that amount, and the other half came from other things, maybe common stocks and corporation bonds, and so forth.

Mr. HANNA. Into certificates of deposit?

Mr. GURLEY. Yes.

Mr. HANNA. What would be your comment, Professor Gurley, on this middle suggestion of Dr. Warburton's about having the Chairman of the Board of Governors serve on the Cabinet of the President?

Do you think this might in any way serve the desirability of coordination that has been talked of?

Mr. GURLEY. Well, I think it would. I am not a political scientist, so it is difficult for me to judge one against the other. I think it would help over the present situation. My proposal was that the Chairman should serve at the pleasure of the President for a 4-year term. If I am comparing that against Dr. Warburton's middle proposal, which you call it, I really don't know. I can't make a judgment on that.

Mr. HANNA. Dr. Warburton, I presume that when you made this proposal, you said you made a final proposal as to what you said you would prefer, did you have in mind in making the Chairman a member of the Cabinet that this would also include the things that Professor Gurley spoke of, that the term of the Chairman would be coterminus with the terms of the President and that he should have the power to select the Chairman from whatever sources he saw fit.

Mr. WARBURTON. That might be possible. The more detailed outline of this proposal, which appears in one of the memorandums that is submitted, does not deal directly with that particular point. It suggests as the first move the grouping of monetary banking and credit agencies into a new department headed by a coordinator, leaving the powers in the various agencies, including the Board of Governors of the Federal Reserve System, much as they are, except of course for shifting the Open Market Committee powers to the Board.

My reasons for making that suggestion are partly of a sort that Professor Gurley referred to as playing the part of a political scientist, though I also am not a political scientist. But I have been impressed with the numerous proposals in the past for consolidating these agencies which have not received sufficient approval to be enacted; and it seems to me that the proposal to group them into a department under a coordinator, who would not have all the powers that the department secretaries have with respect to their activities, would be a very useful step to take at the present time. Under that proposal the question you ask would be reserved for later decision.

Mr. HANNA. My time is up, Mr. Chairman, but I would simply observe that it has appeared to me out of the testimony that we have had, there is some emerging out of the testimony the possibility that perhaps the Congress might very well think seriously about establishing more responsible directives from Congress to the Board of Governors requesting some kind of responsive reporting so that we could know exactly how they are carrying out the directives, and finally this need for coordination, which both of you gentlemen have talked on, between the administration which has the responsibility of carrying out an economic program that fits the whole Nation, and this very important function of monetary policies which can in a sense joust with it or cooperate with it, depending upon the thinking of the leadership of the Board of Governors. That basically is what it seems to me has emerged from the discussions of change for the Board. I would hope that before we get through we could get some discussion as to whether or not these are not three basic points, however you articulate them, that we are discussing here in terms of change.

The CHAIRMAN. I think, Mr. Hanna, that what Dr. Warburton says in his prepared papers which he submitted as a part of his testimony is interesting here. One paper sets forth guidelines for Federal Reserve

operations, and another proposes extension of reserve requirements to commercial banks that are not now members of the Federal Reserve System. Another concerns the capital stock of Federal Reserve banks and one is on proposals for a change in the membership and terms of office of the Governors of the Federal Reserve System, and the relation of the System to other financial agencies of the Federal Government.

Dr. Warburton worked on these subjects over a long period of time. He is highly regarded as is Professor Gurley throughout the United States. Dr. Warburton, you have always remained here in Washington, haven't you, since you have been with the FDIC?

Mr. WARBURTON. Yes.

The CHAIRMAN. And Professor Gurley you are on the staff of Stanford University.

Mr. GURLEY. Yes; that is right.

The CHAIRMAN. Mr. Wilson.

Mr. WILSON. I have no questions Mr. Chairman.

The CHAIRMAN. I would just like to ask a few. I will not detain you gentlemen long. I would like to bring out some points. About the audit—you see the Federal Reserve has never been audited by the Government. It handles hundreds of billions of dollars of Government money every year. It makes no report on its expenditures. It doesn't make any report to the Government of the cancellation and destruction of money, paper money. There are a number of things it doesn't report on.

Don't you gentlemen think that the general acting officer or at least some independent auditor should audit the Federal Reserve System every year? What do you think about that, Dr. Warburton?

Mr. WARBURTON. I think it would be appropriate.

Mr. GURLEY. I don't know, Mr. Patman. Perhaps I should ask for information on this as to whether things have turned up that would suggest that a change should be made in this regard.

The CHAIRMAN. Well, certain things turned up like a \$7½ million loss of Government bonds out at a San Francisco bank. That is a pretty substantial loss, and it's unexplained.

Nobody knows how it happened. Anyway I will not press the point, Professor Gurley. But one point I would like to ask you about concerns the Open Market Committee. Like it is now, the people who control our monetary policy are not all Government employees, dedicated public servants.

Some of them don't even take an oath to support the Constitution of the United States. They participate in these secret meetings of the Federal Reserve Open Market Committee. Do you believe that those minutes should remain secret, Dr. Warburton, or do you think after a lapse of a certain time it would be well for them to be made public or at least subject to the scrutiny and control of the respective congressional committees having to do with this particular subject?

Mr. WARBURTON. I don't know to what extent the detailed minutes of a consultative body, which the Open Market Committee really is, should be made public in full. Certainly the Committee does not make public things that they should. They don't make public enough of their proceedings.

But I think this would become much less important if the powers that they exercise were transferred to the Board of Governors.

The CHAIRMAN. Yes, sir. Professor Gurley, would you like to comment on that?

Mr. GURLEY. I think a good deal more of the minutes in greater detail should be made public, and made public rather fast. I think that within a half year or a year of the final meeting of the year that a good part of the minutes for that year should be made public.

The CHAIRMAN. Now you gentlemen know a lot about the movement of gold.

We always hear about our obligation to transfer gold to other countries, but we never hear anything about our privilege to make other countries transfer gold to us. Do you know about the gold contracts that we have with other countries, Dr. Warburton?

I know we obligate ourselves, the United States of America, to deliver gold to foreign countries upon demand of the central banks.

Do you know of any contracts where we require the delivery of gold to us under certain conditions?

Mr. WARBURTON. No; I don't know what those contracts might be, except that delivery of gold, under some circumstances, might result from the arrangements with the International Monetary Fund, and I would not know the details about that.

The CHAIRMAN. I see. Would you like to comment, Professor Gurley?

Mr. GURLEY. No; I have no comment.

The CHAIRMAN. Now, on certificates of deposit—

Mr. WILSON. Mr. Chairman, I was going to ask this. You asked a question about the minutes of—

The CHAIRMAN. Of the Federal Reserve?

Mr. WILSON. What is the current status of our request for these minutes?

The CHAIRMAN. We haven't heard from the Federal Reserve on that.

Mr. WILSON. You still haven't heard from them?

The CHAIRMAN. We haven't heard from them. If we don't hear some time pretty soon, we will have to call on them, I think.

Mr. WILSON. May I ask a question of Professor Gurley in line with that?

The CHAIRMAN. Yes, sir.

Mr. WILSON. Many of us have gathered that they don't want to extend any of the minutes to the committee under any circumstances, even though they have admitted that there would be no harm in us seeing minutes that are 5, 6, or 7 years old.

Do you see anything that could damage the relationship of our Government with other countries that could be brought out if we had minutes as old as 6 months?

Mr. GURLEY. Mr. Wilson, I think there may be one or two things, a sentence here, a sentence there, but these can easily be struck, and most of the minutes given out. Perhaps you have noticed that in the Federal Reserve Bulletin, of recent months, more information is being published about what goes on in the Open Market Committee meetings, and this is certainly due to the efforts of the Joint Economic Committee, this committee, and Mr. Patman, in trying to get these minutes out.

I see absolutely no harm at all, and it is all to the good, because, you see, once these minutes come out, then right there is the information as to the reasoning that went into certain policies, and this reasoning can be discussed. That is all to the good.

Economists all over, people interested in this sort of thing, should start discussing the reasoning leading up to these policies and seeing whether there are any fallacious turns.

Mr. WILSON. They could be valuable to people like yourselves who are students of the economy?

Mr. GURLEY. They would; but I would hope that the Federal Reserve itself would benefit from an intelligent discussion.

Mr. WILSON. Thank you, Mr. Chairman.

Mr. WARBURTON. I would agree.

The CHAIRMAN. Now, on certificates of deposit, that is a somewhat new procedure, isn't it?

It hasn't been going on very long. How long would you say, Dr. Warburton? Having been with the FDIC you would be pretty well acquainted with it I am sure.

Mr. WARBURTON. I am not acquainted with the recent procedure in any detail. Banks have issued certificates of deposit for many decades. The negotiable time certificates which they are now issuing, as I understand it, are a relatively new innovation.

The CHAIRMAN. Yes, sir.

Mr. WARBURTON. But I have not paid any particular attention to that development.

The CHAIRMAN. It occurs to me that the certificates of deposit could influence the interest rate, the interest rate on Government bonds. Does that seem reasonable to you, gentlemen?

Mr. GURLEY. Yes; I can think of several ways that it might. Do you have something definite in mind, Mr. Patman? I am sure you do.

The CHAIRMAN. Well, 4 percent you know is a pretty good return, and they are even trying to get the ceiling taken off.

Mr. GURLEY. Yes; that is right.

The CHAIRMAN. And they represent about ten and a half billion dollars now. You know, I would consider that pretty unstable money. Of course, I know the banks desire to get the deposits. I appreciate that because banks have to be profitable. They have a pretty good deal as it is for as a group they can make loans and investments equal to about \$10 for every \$1 that they have in reserves and they can acquire a million dollars in reserves by selling a million dollars worth of bonds to the Federal Reserve.

Many of these bonds belong to a customer. Still the bank gets credit for what amounts to high-powered dollars, and these high-powered dollars permit the bank selling the million dollars worth of bonds to pay its customer with \$1 million, and then the banking system can create \$9 million more on that reserve by either making loans at interest or investments with interest. So that provides a pretty good return there. The reserve requirements have been going down since 1953 and this also has made it so banks have been making pretty good money, for which I am very glad. I think we should have the banks make good money. We must have a profitable banking system. We can't have a good banking system unless it makes money, and I am all for it.

Mr. GURLEY. Mr. Patman, there is as you indicated, and there will be throughout the year I am sure, pressure to increase the ceiling rate of interest on these certificates of deposit.

The CHAIRMAN. Yes, sir.

Mr. GURLEY. Now if that rate is increased, then what will happen to the interest rate on Government bonds depends upon how the Federal Reserve looks upon the increase in certificates of deposit.

What might happen is that the banks may be allowed to increase their certificates of deposit as demand develops for them, a higher interest rate on them, and at the same time be allowed to keep the demand deposits they have. That is, they will be given enough reserves to hold their current demand deposits, and to hold an increasing amount of time deposits. If this is so, then the interest rate on Government bonds will not go up.

An increase in interest rates on certificates of deposit will not necessarily raise interest rates on Government bonds. It will all depend on the actions of the Federal Reserve in response to this.

The CHAIRMAN. I want to add to what I said. Of course, a bank may think it must have deposits to make loans and that causes it to try to find every way in the world to get deposits. I am not charging that they are doing this, but I can see where it would be possible for a bank to think it needed deposits badly and to make some arrangement with the customer to say "You borrow \$1 million from us and we will lend it to you for 2 percent, and then with the understanding that you will keep that on deposit here and we will pay you 4 percent for it."

That is what the going rate is now. In that way nobody would be out any money but the person doing the borrowing would make \$20,000 a year on a 4-percent basis.

I don't charge that they are doing that, but it just occurs to me like that some banks may think that that kind of a loophole is available to them if they want to use it.

Mr. GURLEY. Mr. Patman you say no one loses money because you are thinking that the bank can expand in some multiple fashion, is that it, so that it makes up for the difference between 2 percent and 4 percent? It is earning 2 percent and paying 4 percent in your example.

The CHAIRMAN. That is right. You see like it is now they are paying 4 percent.

Mr. GURLEY. Yes.

The CHAIRMAN. They are just losing 2 percent, I mean they get a 2 percent differential there. They are out only 2 percent instead of out 4 percent.

Mr. GURLEY. Well, they are out something; yes.

The CHAIRMAN. Yes. There is a difference there of 2 percent.

Mr. HANNA. Is it your suggestion then that they could take that loan and collateralize that loan and in some way get credit for a reserve of some kind which would loosen money then to be put out at 6, 7, or 8 percent?

The CHAIRMAN. I don't know what all the effects would be. I can see a number of effects by reason of it.

In fact, I don't even know that it is going on. I am just stating that as a possibility. I doubt very much if banks would engage in



that sort of a practice on any large scale, if any. I just know that it is something that is available that possibly would be done. But I guess it would not be done. Are there any other questions?

All right, gentlemen, you certainly have the gratitude of the members of this committee for your testimony. We have one volume of that testimony out. It was just made available a few days ago.

There is a great demand for these records, and we appreciate particularly the testimony from distinguished gentlemen like yourselves who have knowledge of these subjects.

Tomorrow we have Prof. Harold Barger of Columbia University and Prof. Ross Robertson of the University of Indiana.

Wednesday we have Dean George Leland Bach, of the Carnegie Institute of Technology, and Professor Lerner, of Michigan State University.

Thursday we have Prof. Robert Strotz, Northwestern University, and Prof. Dudley Johnson of the University of Washington.

You gentlemen may extend your remarks if you desire to do so in looking over your transcript, if you see something you have forgotten you can include it.

Thank you gentlemen, very much. We will stand in recess until 10 o'clock tomorrow morning.

(Whereupon, at 11 :20 a.m. the subcommittee adjourned, to reconvene at 10 a.m. Tuesday, March 10, 1964.)

# THE FEDERAL RESERVE SYSTEM AFTER 50 YEARS

TUESDAY, MARCH 10, 1964

HOUSE OF REPRESENTATIVES,  
SUBCOMMITTEE ON DOMESTIC FINANCE OF THE  
COMMITTEE ON BANKING AND CURRENCY,  
*Washington, D.C.*

The subcommittee met, pursuant to recess, at 10:05 a.m., in room 1301, Longworth House Office Building, Hon. Wright Patman (chairman) presiding.

Present: Representatives Patman, Reuss, Vanik, Hanna, and Brock.

The CHAIRMAN. The Subcommittee on Domestic Finance will please come to order.

We have as our witnesses this morning Prof. Harold Barger, of Columbia University, and Prof. Ross M. Robertson, University of Indiana.

We are glad to have you gentlemen. Each one of you has a prepared statement I notice and you may proceed in your own way.

Professor Barger, you may proceed in any way you desire. You may insert your statement and comment on it or you may read it or present it in any way that you desire.

## STATEMENT OF HAROLD BARGER, CHAIRMAN, DEPARTMENT OF ECONOMICS, COLUMBIA UNIVERSITY

Mr. BARGER. Thank you, sir.

Mr. Chairman, my name is Harold Barger. I am chairman of the department of economics at Columbia University, New York City.

Mr. Chairman, I have been invited to comment on five bills before the committee.

H.R. 3783 would retire the stock of the Federal Reserve banks and convert the legal form of the Federal Reserve System from a federally supervised cooperative, owned by the member banks that are its customers, to an arm of the U.S. Government. I believe that the practical consequences of this measure would be negligible. The management of the Reserve System is already in the hands of public officials who are fully aware that monetay policy must be conducted for the public benefit and not for the benefit of member banks or their stockholders. Public understanding of this fact might, however, be enhanced by enactment of the bill, which would have the advantage of bringing form closer to reality. On the other hand, I agree with Chairman Martin that enactment of the bill would make membership in the Federal Reserve System less attractive. Therefore, owing to the importance of System membership, I do not think H.R. 3783 should be enacted unless coupled with a measure to require all commercial banks

to become members of the System. This is a controversial issue that has been debated much over the years, as you know, Mr. Chairman.

H.R. 9631 would enlarge the Federal Reserve Board from 7 appointed members to 11 appointed members plus the Secretary of the Treasury, and would reduce the terms of the appointed members from 14 years to 4. It would further abolish the Federal Open Market Committee and transfer the conduct of open-market operations to the reconstituted Board.

Since the accord of 1951, the chief weakness of Federal Reserve policy, in my judgment, has been indecisiveness. Too often policy moves that were in the right direction were made only after delay of weeks or months. This indecisiveness has arisen in part from division of opinion within the Board of Governors, as we know, or the Federal Open Market Committee. Often it is more important that some decision should be made promptly, even on partial evidence, than that matters should be allowed to drift; if a wrong decision is taken it can always be reversed. The larger the Board, the more indecisive its behavior is likely to be. Therefore I believe that an increase in the size of the Board would be a retrograde step, and that the Board should rather be made smaller or even be reduced to a single administrator. If it be argued that the increase in size is needed because the workload of Board members is now excessive, I would advocate the transfer to other agencies of some of the functions which have nothing to do with monetary policy. For example, bank examination might well go to the Federal Deposit Insurance Corporation; control of branching and the administration of holding company law to the Department of Justice.

Past experience suggests that to make the Secretary of the Treasury a member of the Federal Reserve Board would not be wise. From 1914 to 1936 when the Secretary was a member of the Board, the record indicates that he was frequently too busy to attend to the Board's business. Moreover, because of their responsibility for debt management, Secretaries of the Treasury tend to give excessive weight to minimizing the dollar cost of debt service. This is important but it is a consideration that must give way at times to others. It is the job of Board members to weigh this objective against other, frequently more important objectives. They can best discharge this function if they listen to the Secretary, but do not have him in the boardroom to overawe them. Therefore, I do not favor making the Secretary of the Treasury a member of the Board of Governors. I noted the other day that Secretary Dillon disclaimed any desire to be in the boardroom with the other Governors. This may have been unwillingness to shoulder responsibility; but as I have indicated, I think there are more fundamental reasons why the Secretary should not be a member of the Board.

Coordination of monetary policy with the general economic policy of the President obviously is necessary, however. Monetary policy is a highly technical business. Therefore a long term of office is an advantage, for shortening the term of office would increase the turnover of the Board's membership. When the Board has 7, still more if it has 12, members responsiveness to Presidential policies should be attainable even with the current 14-year term of office. First, the terms of Governors should be made to expire in odd-numbered instead

of even-numbered years, so that immediately upon entering office an incoming President would always be able to appoint at least one Governor. Second, the present 4-year term of the Chairman of the Board of Governors should be made to expire at the time each newly elected President is inaugurated. These are desirable reforms. I do not favor a reduction in the terms of office of Board members, unless it should be decided to diminish the size of the Board or to appoint a single administrator.

I do not favor a large, new Federal Advisory Committee as proposed in section 2, for I believe the Board of Governors already has ample means of obtaining advice. The existing Federal Advisory Council seems to have performed a useful function in bringing technical problems of member banks to the attention of the Board, and should not be abolished.

Discount policy and member-bank reserve requirements are already in the hands of the Board of Governors. It is illogical that the management of open-market operations, an equally important aspect of monetary policy, should be located elsewhere; that is, in the Federal Open Market Committee. I support the proposal in section 3 to abolish the Federal Open Market Committee and to transfer its functions to the Board of Governors.

I believe the present arrangements for audit of the Federal Reserve Board and the Federal Reserve banks are satisfactory, and I do not favor provision for audit by the General Accounting Office, as proposed in section 4.

In sum, with respect to H.R. 9631, I do not favor section 1, but would support instead an amendment to terminate the 14-year terms of Governors and the 4-year term of the Chairman in odd-numbered instead of even-numbered years. I do not favor section 2; I favor section 3; and I do not support section 4. I am not scared by the notion that the President should have influence over the Board of Governors. I think fundamentally this is a necessity in a democratic community. I am more concerned, though, that if the Board is to be independent, it should be independent not so much of the White House, as independent of the Treasury.

H.R. 9685 would require the Reserve banks to pay to the Treasury all interest received on U.S. securities owned by them; that is, most of their present gross receipts. Instead the expenses of the Federal Reserve System would be met from congressional appropriations.

I believe the present arrangement whereby the System meets its expenses out of earnings, but turns over surplus revenue to the Treasury, is preferable. The proposed change would risk subjecting monetary policy to congressional direction through the withholding of appropriations. It is axiomatic, Mr. Chairman, that in a democratic and self-governing society, monetary policy should be fully subordinated to control by the administration of the day, and that its coordination with other aspects of economic policy should be assured. But I do not believe that Congress is equipped to undertake such control and coordination of day-to-day monetary policy. In my opinion effective direction of the Reserve Board must come, not from Congress, but from the President. Such direction should come, not through the power to withhold appropriations, but through the selection of a Chairman and Governors in whom the President has confidence. I do not recommend the passage of H.R. 9685.

H.R. 9686 would permit the Treasury to require the payment of interest by commercial banks on the whole or part of its deposits with them. I think this has merit. In return commercial banks would be appropriately compensated for services performed. This proposal embodies good housekeeping and is long overdue. I favor passage of H.R. 9686.

H.R. 9687 would repeal the prohibition on the payment of interest on demand deposits by commercial banks. This prohibition, which has proved difficult to enforce, was intended to reduce competition for depositors and to prevent bank failures through excessive interest payments to depositors. Competition for depositors is desirable and thanks to deposit insurance bank failures are no longer a problem. I favor passage of H.R. 9687.

Before leaving the subject of legislative revision, I should like to support the plea made by Chairman Martin before this committee 3 weeks ago for the passage of the Kilburn-Robertson bill (H.R. 8505) to eliminate the penalty rate on discounts secured by ineligible paper. This is an anachronism which goes back to the original Federal Reserve Act. In the original Federal Reserve Act the eligibility concept was based on a misunderstanding of the way money works.

I have also been asked to comment on recent Federal Reserve policy with respect to the level of interest rates and the money supply.

On July 22, 1963, Chairman Martin told this committee with his customary frankness:

As you all know, I regard the problem of the balance of payments as vital, and I am convinced that our failure to solve it up to now has not only been damaging to our international relations but also has impeded the achievement of ever higher levels of output and resource utilization in our domestic economy \* \* \*.

The international payments problem confronting us is not a passing, transitional thing that will shortly go away if we only wait patiently for it to disappear. The biggest and best bank in the world could not count on others to keep adding to their balance with it indefinitely, without regard to their own cash needs and alternative uses for their funds, and it would be neither wise or safe to do so.

With the single exception of 1957, when U.S. exports burgeoned in the wake of the world crisis over Suez, the United States, year in and year out for a dozen years, has been witnessing a persistent buildup of its short-term liabilities to foreigners \* \* \* in consequence of the perennial deficit in our international payments accounts. In 1963, that deficit in our accounts still persists, and it is not growing smaller.

I agree with Chairman Martin that interest rates have indeed been too high and the expansion of the money supply too slow to secure the degree of utilization of our resources of which we are capable. It seems certain that our employment rate would be lower today, and our gross national product larger, had monetary policy been somewhat easier during the past 2 or 3 years. But I also believe that the Federal Reserve has shown extraordinary skill in keeping money just tight enough to bring gold losses to a practical halt, without doing any more damage to domestic employment and the growth of the gross national product than proved absolutely necessary. A minority of the Board of Governors feels that money could be easier without causing larger gold losses. I do not believe that this opinion is justified. I prefer the judgment of Chairman Martin and the majority on this point.

The dilemma inevitably raises the unpleasant question whether a realignment of currencies may not ultimately be necessary, and if so, how much longer we are wise to prolong the present agony. Obviously the matter is one that lies quite outside the province of the Federal Reserve and of monetary policy, and calls for consideration by the Treasury and the International Monetary Fund. Since the Fund was established, many nations have experienced balance-of-payments difficulties, and the Fund has recognized that a change in the par value of their currencies was a proper way of correcting payments deficits, if such deficits resulted from what it classed as a "fundamental disequilibrium." If a nation applies for a change of par value, it is up to the Fund to determine whether such a "fundamental disequilibrium" exists. Chairman Martin feels that our payments deficit is now about 12 years old. May it not perhaps reflect a "fundamental disequilibrium"? Thank you, Mr. Chairman.

The CHAIRMAN. Thank you, sir.

Professor Robertson, you may proceed in your own way.

**STATEMENT OF ROSS M. ROBERTSON, PROFESSOR OF BUSINESS ECONOMICS AND PUBLIC POLICY, GRADUATE SCHOOL OF BUSINESS, INDIANA UNIVERSITY**

Mr. ROBERTSON. Mr. Chairman and members of the committee, my name is Ross M. Robertson. I have been a member of the faculty of Indiana University since 1957; and I am presently professor of business economics and public policy and director of business history studies. Before coming to Indiana University I was financial economist at the Federal Reserve Bank of St. Louis.

I appreciate the opportunity to appear before this committee to testify on bills relating to both the organization of the Federal Reserve System and the payment of interest by commercial banks on demand deposits. My introductory statement is necessarily brief, and I will be happy to expand upon this written testimony.

The CHAIRMAN. You may insert the remarks you do not actually read into the record.

Mr. ROBERTSON. Thank you.

Of the several bills pending before this committee, H.R. 9631 has the most important economic implications. The bill would change the size, composition, and structure of the Federal Reserve Board in such a way as to effect profound changes in the American monetary authority.

The organization of the Federal Reserve System is plainly anachronistic. But, of course, it always was. When the Federal Reserve System was established in 1913, there was widespread fear of a central bank; to overcome public prejudice against a central bank it was necessary to establish 12 regional banks, each presumably to have a certain autonomy subject to broad supervisory powers of the Federal Reserve Board. It is, I think, relevant that the framers of the act made both the Secretary of the Treasury and the Comptroller of the Currency members of the Board ex officio, this provision being inserted as a protection against too much "independence" on the part of the central bank. Nearly 51 years after the passage of the original Federal Reserve Act it has become apparent that the 12 Federal

Reserve banks are in a sense simply branches of the central bank under the control of the Board of Governors in Washington. As I have written elsewhere:

\* \* \* a realistic appraisal of System structure in terms of its genuine power centers leads to only one conclusion—that the regional structure, adopted by the framers of the Federal Reserve Act two generations ago, is presently out-moded \* \* \* We may as well face up to the fact that the Federal Reserve banks have become only operating offices with responsibility for service functions and not, in any real sense, for monetary policy.

One of the reasons for the polarization of control of the system in Washington is the decline in both the use and usefulness of the discount rate as an instrument of American monetary policy. The chief role that the individual banks play in monetary policy is through the involvement of 5 of the 12 Presidents in Federal Open Market Committee membership. It is my own view that the Presidents, though they are strictly speaking voting members, actually serve primarily in the capacity of advisors. We must not forget that the President and First Vice Presidents of the several banks are appointed only after approval by the Board in Washington, and it is my judgment that the several bank Presidents defer to decisions of the Board, and particularly of the Chairman.

Member banks no longer have free access to the discount windows of the several Reserve banks strictly on a rate basis, but instead may borrow only within the constraints of regulation A, the complex and meddlesome set of rules by which the 12 discount windows are presently administered. I think it is pertinent to recall here that the discount rate was to be the only instrument of policy at the time of the inception of the System. Moreover, though the Federal Reserve still maintains the fiction of having discount rates set by boards of directors of the several Reserve banks, they are in practice raised and lowered upon the initiation of the Board of Governors. The consequence has been that monetary policy is now primarily effected through open-market operations, which are carried on in great volume on a day-to-day and even an hour-to-hour basis. I might interject at this point, that—and I am recalling these figures only approximately—during the calendar years 1957–59, 3 calendar years, gross open-market operations amounted to \$36 billion to achieve a net Reserve injection, as I recall, of \$1.7 billion, which in turn just offset the gold outflow. This seems to me a great deal of monkeying around in the marketplace for very little net effect. The further consequence has been that Reserve injection and absorption depends little on the initiative of commercial banks and almost entirely on the volition of the central bank.

These considerations lead in strict logic to the conclusion that, since control of the monetary system is so highly centralized in Washington, we may as well go the whole way and have a single monetary authority, combining the central bank and the Treasury. There is much to be said for this view. I am nevertheless reluctant to recommend that the central bank become a part of and completely dominated by the Treasury. My first reason is that such a move would imply a sharp break with tradition, with history, and as an historian, I am inclined to move slowly in changing our institutional arrangements. The Federal Reserve has earned the complete and genuine confidence of the

financial community. Institutional arrangements of this sort are, in fact, significant, and a half century of experience suggests that many of the present relationships of the central bank to the commercial banking system are so firmly established that it might be harmful to undo them.

Second, although in my view it is foolish to argue that the Federal Reserve ought to be politically independent, it seems to me that there are values in maintaining the intellectual independence of the System. I think it is good for both Federal Reserve and Treasury officials to think things through separately, and I can testify that both organizations have absolutely first-class research talent.

Third, if we could reestablish the discount rate as a genuine money market rate—and not just as a psychological indicator of central bank policy—the several regional banks might once again serve an effective role in matters of monetary policy.

With these considerations in mind I make the following recommendations. I see no reason for increasing the membership of the Board from 7 to 12; indeed, a Board of 5 members could deliberate more effectively and perform executive functions better than a larger Board, and a Board of 12 would fall even further under the dominance of the Chairman. I do not concur in the proposal that the Secretary of the Treasury be made Chairman of the reconstituted Board. I do, however, suggest that both the Secretary of the Treasury and the Comptroller of the Currency be restored to membership on the Board *ex officio*. Moreover, I think that this committee might well consider the possibility of appointing a member of the Council of Economic Advisers and a representative of the Bureau of the Budget as members *ex officio* of the Board of Governors. I am aware that the Budget Director and his assistants, like members of the Council of Economic Advisers and the Secretary of the Treasury, are tremendously busy men. But I cannot think of any work that should take priority over the counsel they might give the central bank on matters of monetary policy. It seems to me that the presence of Treasury officials on the board would assure consistency of policy that has too often been lacking in postwar years and would at the same time not destroy the cherished independence of the Federal Reserve.

I am perfectly well aware, incidentally, of what, in a sense, is a conflict of objectives—I should not say of interest—of the Secretary of the Treasury with monetary policy, and I am well aware that Secretaries of the Treasury often take advantage of falling interest rates to stretch out maturities of the public debt. So doing they work at odds with the central bank. This certainly happened in the spring of 1958. My answer to this argument would simply be that perhaps the Board could make a Christian out of the Secretary of the Treasury when it comes to debt management policy and that membership on the Board would imply a two-way street of advice that might be extremely helpful to both Treasury and the Fed.

I concur in the view that the term of Board members should be 4 years. I further concur in the proposal that Board members serve at the pleasure of the President. Finally, I approve the proposal that appointed members of the Board be ineligible during the time they are in office and for 2 years thereafter to hold any office in a member bank, and I feel that this provision should apply also to members who



have served the full term for which they were appointed. I might interject here that in my view reappointment of Board members to a second term of 4 years should be allowed.

I would hope that the Board would in the future be composed primarily of economists who have served in both governmental and academic positions. I do not feel that the 4-year term of office would work against the recruitment of men of first-class abilities for Board service. In this connection I would point out that the universities of this country are now conditioned to allowing their faculty members to take extended leaves for Government service, and I am sure that public agencies and private business firms would be delighted to make their staff officers available for such service.

In my opinion the present Federal Advisory Council serves only to provide honorific positions for distinguished citizens in the several Reserve districts. I do not see that there would be any gain in providing even more honorific positions through the establishment of a Federal Advisory Committee, particularly one as large as that proposed in this bill. Free advice of this kind is not likely to be of much use to anyone.

Section 3 would transfer the powers, duties, and functions of the Federal Open Market Committee to the new Board. Such a move would certainly spoil one of the real rewards of being a Reserve bank President, and I do not see any particular gain to the public resulting from such a change. But since the Board, and more particularly its Chairman, have the final say in such matters, I really do not see that a change in these arrangements would make much difference one way or another.

Section 4 would make the Federal Reserve banks subject to audit by the General Accounting Office. It is my conviction that the American central bank should have a certain freedom of expenditure not vouchsafed to other Government agencies, the reason being that its officers must necessarily entertain both businessmen and foreign dignitaries in a traditional and customary manner. It is my personal observation that Federal Reserve banks are managed with restraint and great consciousness of the necessity to conserve resources.

I might add, Mr. Chairman, that the work of this committee has certainly impressed upon the several Reserve banks the necessity for watching expenditures and in my opinion there is no excessive expenditure at the moment. Moreover, officers of the Federal Reserve System are invariably men of the highest integrity. Finally, I can vouch for the fact that the accounting departments of the several Reserve banks are as apprehensive of a Federal Reserve audit as they would be of an audit by the General Accounting Office. It is my judgment that the Federal Reserve need not be made subject to official scrutiny of its affairs by the Comptroller General.

H.R. 9685: This bill would subject the Federal Reserve System to congressional appropriation. I see no compelling reason for such a provision, and I think it would be intolerable to have the service functions of the central bank in even the slightest danger of interruption. The very essence of a central bank is the money-creating power. The foundation of the money-creating power lies in the fundamental fact of economic life that a central bank can write a check on itself. It

seems to me inconceivable that an institution with power to write checks in the amount of billions of dollars per annum to carry on open-market operations should be required to come as a suppliant to Congress for the relatively minor expenses of its operation.

H.R. 3783: This bill would retire existing Federal Reserve bank stock and substitute certificates of membership. There is no reason in either logic or economics why this provision should not be put into effect. The amounts of money involved are trivial, and the Federal Reserve Board could as well appoint all nine directors of the several Reserve banks as only three of them. Indeed, it is by no means necessary to maintain the apparatus of directorates of Federal Reserve banks and their branches. Nevertheless, this system is in the tradition of commercial banking, it has had just over half a century of use in this country, and there is something to be said for maintaining even so tenuous a connection of the central bank to commercial banking throughout the United States. At this point, gentlemen, I would like to underscore the fact that the money market banks, the big institutions of this country certainly have direct access to major figures in both Treasury and Federal Reserve.

The money market banks are able to express their views directly to both Treasury and Federal Reserve officials, and I feel that banks in the provinces should have some means of communicating their views to the monetary authority. On balance, I would be inclined to keep this institutional arrangement as it is. I would repeat, however, that the question of stock ownership in Federal Reserve banks is not earthshaking.

H.R. 9687: The subject of interest on both demand and time deposits has been controversial for at least a century. Largely at the insistence of Senator Glass, the Banking Act of 1933 prohibited the payment of interest on demand deposits by member banks, and in January 1934, the FDIC similarly prohibited nonmember insured banks from paying interest on demand deposits. Reasons customarily advanced for this proscription were that city banks "stripped" country banks of their spare funds, that such funds were customarily used in the money centers for stock speculation purposes, and that withdrawals of such funds by country banks on occasion induced severe money stringencies in the cities. In the twenties, another argument was added—that the payment of interest on demand deposits, by raising bank costs, pushed banks into riskier (that is, higher yield), investments and, therefore, ran against the requirement of maintaining bank safety. I do not comment on these arguments; I am simply reporting them to you.

The historic reasons against payment of interest on demand deposits are less compelling today, largely because of changes in the money and capital markets over the past generation. New money market instruments such as negotiable certificates of deposit make this whole question unexciting in a modern context. A removal of present restrictions on the payment of interest on demand deposits would almost surely raise the costs of commercial banks and so, in the absence of central bank intervention, the costs of borrowing. Since the individuals and corporations (including banks) receiving interest on demand deposits would be those with larger balances, I am inclined to think that smaller borrowers would bear the brunt of this higher cost of money.

H.R. 9686: Anyone who reflects on the destabilizing effects of Government receipts and disbursements during the days of the so-called Independent Treasury must be gratified at the progress made during this century. We are told that the United States is the envy of the world because of the smoothly functioning machinery developed to mitigate the destabilizing effects of Federal receipts and expenditures. I, for one, am disinclined to risk any reduction in the effectiveness of this mechanism, particularly in view of the services presently rendered the Government as payment for funds of the United States held on deposit in commercial banks.

Clearly the Treasury and the General Accounting Office are at odds on this point, a Treasury study concluding that the tax and loan accounts are not inordinately profitable to the commercial banks, a General Accounting Office study taking the position that they are. I have made no research study of the matter at issue, but informal discussions with commercial bankers lead me to the view that for most commercial banks an interest payment of even 1 percent on U.S. deposits would turn these accounts from slightly profitable to loss accounts. In the absence of really compelling evidence to the contrary. I would advise against tampering with what seems to be an ingenious social innovation.

I was asked also to make comments on current monetary policy but I think I have taken enough time for my prepared statement. I am more than delighted to discuss the pros and cons of recent policy in this country, but I think, Mr. Chairman, I will simply wait until the ensuing colloquy.

The CHAIRMAN. I am sure some member will ask you about that.

Mr. REUSS. Professor Robertson, in your paper, you indicated that you did not support the proposal to transfer the present functions of the Federal Open Market Committee to the seven members of the Board. As the principal reason for your position, you state on page 6:

Since the Board, and more particularly its Chairman, have the final say in such matters, I really do not see that a change in these arrangements would make much difference one way or another.

I am not sure I quite follow you on that. The 5 Federal Reserve bank Presidents, who are presently among the 12 members of the 12-man Open Market Committee, by getting on their side 2 members of the 7-man Board of Governors of the Federal Reserve could dominate open-market policy. The majority of the publicly appointed members, namely five out of seven, would find themselves in the minority on open-market decisions. It may not work out that way in practice, but such a division is certainly possible. I wonder if this possibility does not alter your position.

Mr. ROBERTSON. You are quite right. There is just no doubt about it that the five members—the five bank Presidents, one of whom is always the President of the New York bank—could indeed, by securing the support of two members of the Board, take us back to pre-1928 days, when the governors of the several Banks did indeed dominate system policy.

Here I must confess that my prejudgments are showing. I feel very strongly that the Presidents of the several Banks, though men

of considerable executive abilities and on rare instances of considerable forcefulness in matters of monetary policy, do in fact defer to the Board.

Mr. REUSS. If I may interrupt you at this point—later on, on page 6 you say, “Officers of the Federal Reserve System are invariably men of the highest integrity.” Are you suggesting that a Federal Reserve bank President, acting as one of the five members of the Federal Open Market Committee, and convinced that money should be made more plentiful, let us say, would kowtow to Mr. Martin, at the time Mr. Martin did not believe this?

Mr. ROBERTSON. The word “kowtow” embarrasses me.

Mr. REUSS. I refer to actual decisions and not to the manner in which a Federal Reserve bank President deferred to the opinion of the Chairman of the Federal Reserve Board.

Mr. ROBERTSON. Here I would like to suggest that I make available to this committee—I do not have copies with me—a magazine article published in the spring 1962 issue of *Business Horizons* co-authored by me and a former colleague at the St. Louis bank, Prof. Delbert C. Hastings, of the University of Minnesota. The article is entitled “The Mysterious World of the Fed.” In this piece we spell out at some length our sense of the nodes of power in the Federal Reserve System, the tenuous relations that exist among the power centers, and so on.

Now, my answer to your question would be that it is not likely that the appointment of a Federal Reserve bank President will nowadays be approved by the Board unless there is a reasonable certainty that the new President will have orthodox views regarding money matters; and I submit that in recent years orthodox views (I hope no one will take offense) have been the views of Chairman Martin, who has dominated System councils for a dozen years. What we now read in press is probably true, that recent Board appointments have been rather stronger than formerly, and that some of the new Board members are disposed to carry on full and frank discussions in a way that Board members did not, let us say, during the decade of the 1950's. Nevertheless, I am positive that Reserve bank Presidents are not valued for their independence of thought. To give you a specific instance, Mr. Sproul when he was President of the New York Fed was a continuing and considerable embarrassment to the Board, and I feel strongly that the Board, as then or now constituted, would have no more of so strong an executive at the bank level. You understand, sir, these are matters of historical judgment and opinion, I know there will be a good bit of diversity of opinion on this subject, but I also know that you could get a great number of professors in the academic community to testify with me to this generalization.

Mr. REUSS. I think, Professor Robertson, the article which you and Mr. Hastings wrote would be of interest to the committee, and would you be good enough to file a copy?

Mr. ROBERTSON. I will do that.

The CHAIRMAN. It may be inserted in the record.

(The document referred to may be found in the appendix beginning on p. 1519.)

Mr. REUSS. On page 7 of your statement, Mr. Robertson, you disagree with the suggestion that the Federal Reserve System be subject to the congressional appropriations procedures. The reason you cite

for your position is that—and I am quoting—“the very essence of a central bank is the money-creating power.” You say it seems inconceivable that an institution, with power to write checks for billions of dollars per annum to carry on open-market operations, should be required to come as a suppliant to Congress for the relatively minor expenses of its operation.

I grant you that the Fed does have this power to create billions of dollars in new money. Is it not a fact, however, that the U.S. Treasury through a power, exercised in the administration of President Lincoln, for example, to print currency, can also create money? and is not the Treasury subjected to the process of coming to Congress for money for its appropriations?

Mr. ROBERTSON. It is conceivable that the Congress would once again give the Treasury authority to participate in the money-creating power in this sense, of simply issuing an officer's check which, upon being presented for payment to the issuing institution, presently the Federal Reserve, is recognized as a good and valid instrument. But within present laws regulating the issuance of Treasury cash, the power of the Treasury to create money is negligible. It could of course be restored, I do not deny that. I simply say that under present rules the Federal Reserve has limitless powers within the not very severe constraints of the requirement of a gold certificate reserve to create money, and it does so through its vast open-market operations.

I am simply making the point that I see no reason to burden either the Congress or the Federal Reserve banks with any constraints regarding appropriated funds. It seems to me, sir, in other words, that it is not really an important matter. I think that is the burden of my testimony.

Mr. BARGER. I would agree, sir, particularly that the power of the Treasury to create cash is now negligible, but I think there is a more important reason why I would oppose the notion that the expenses of the Reserve should be met from congressional appropriations.

I can see very little reason for subjecting the central bank to the procedure of congressional appropriations except as a means of exercising power. I think that it is entirely right and proper that the Congress and the administration should exercise power ultimately over the behavior of the Reserve System. I made that very clear, but we are talking here about open-market operations, and day-to-day decisions which are of a highly technical nature and involve a great degree of judgment; and I simply do not believe the Congress or congressional committees are in a position to conduct day-to-day monetary policy; and since they are not in a position to do that it seems to me the proper way for Congress to control the Reserve System is through hearings, through legislation, but not through the appropriations procedure. That is my position.

Mr. REUSS. I wanted to ask you another question, Professor Barger, suggested by a point you make in your paper. You ask whether there may not be a fundamental disequilibrium in exchange rates today and whether a readjustment may not be necessary. I would like to ask you a question in that connection.

In view of the fact that our export position has held up rather well in recent years and has consistently been showing something like

a \$5 billion surplus over imports, and in view of the fact that the big crushing items in our balance-of-payments deficit have been American defense expenditures abroad, and, until very recently, private capital investment abroad. I wonder if really there is a fundamental disequilibrium? Would devaluing the dollar actually solve anything?

Mr. BARGER. Well, sir, I am not clear that if such a remedy were needed a straight devaluation of the dollar would be appropriate. There are many variations of this.

I think that a realignment of exchange values, particularly with Western Europe and the Far East through the agency of the International Monetary Fund would be the proper procedure. However, to answer your question, sir, I would say that we have a payments deficit which is not getting any worse, and I would say over the past year has shown perhaps some little improvement. But I regard this as an achievement, a great achievement, but at a very considerable cost. The cost I think we have paid for this improvement, or at any rate for this absence of any worsening in the balance of payments, the cost that we have paid for this has been the fact that we have conducted our monetary policy in a less easy fashion than we would have liked from the standpoint of domestic objectives. I think that the restrictive policy, if you wish to call it that, which we have all been tempted to complain bitterly about, with the 5.5-percent unemployment rate, is a policy that may not be tight, but it is not as easy as it could be. We all would like it easier for domestic reasons. I think the fact that it has been kept as tight as it has, has had a rather powerful effect in restraining wage increases, price increases, improving our export situation, and improving our balance. And I think that the improvement, if we get out of the woods, will be at a considerable cost in terms of domestic slack in the system. I don't know whether that answers your question, Mr. Reuss.

Mr. REUSS. Thank you very much.

Mr. ROBERTSON. If I could just make one comment, I would like to point out, too, that certainly we must give a great deal of weight to the so-called interest equalization tax that was levied on American investors in foreign securities—but this is an interference with free exchange of goods and services.

The CHAIRMAN. Mr. Brock?

Mr. BROCK. I would like to pursue this subject for just a moment, Professor Barger.

When you talk about changes in the relationship or the par value between our currencies and other ones using the structure of the International Monetary Fund, how could you do this without changing the relationship between the dollar and gold?

Mr. BARGER. The vital relationship is the competitiveness of American industry in world markets and that is a function of the exchange relationships between the dollar and other currencies. One possible way of improving our competitive relationship, eliminating the disadvantage which we suffer in our cost structure at the present time, would be simply for us to raise the price of gold and assume that no one else would do the same. I think that is too optimistic. After all, other countries can choose what price of gold they please,

and if you want to avoid competitive devaluation or competitive bidding up the price of gold, you want to do it through an agreement under the auspices of the International Monetary Fund.

Whether the dollar price of gold should rise, or as happened in the case of Holland and Germany a while back, the price of gold in those countries should fall, is to my mind a matter of convenience and tactics. I don't think it is fundamental.

Mr. BROCK. I am afraid that under the structure of our present law we cannot change the value of the dollar without changing the price of gold; can we?

Mr. BARGER. I would suppose that without changing the official price of gold, placing an embargo on the sale of gold would effect the same result, although the official price of gold, legal price of gold would be unchanged. But this is something that, of course, is a matter for the Congress to take under advisement; and after any provisional arrangements of this sort had been made it would be obviously necessary for the Congress to ratify any arrangements of this sort.

Before I leave the matter there is one other point regarding the price of gold which is: I don't think the price of gold in dollars is important. On the other hand, there are people who fear for the long pull, a shortage of gold, who fear that a shortage of international monetary reserves is in prospect. If you believe that, then there is no question in my mind that any arrangements for realignment of currencies of the kind that I have indicated should be coupled with a general increase in the price of gold in order to expand international monetary reserves. But that is an entirely separate question, really.

Mr. BROCK. Professor Heller was before our committee some months ago and I asked him the question: What would be the action of this Government or what would he recommend if the current outflow of gold continued to the point where we had no gold left to meet our obligations—would we devalue, and Professor Heller, as I recall, said, no, that is not part of our philosophy, that perhaps an alternative would be that we should remove the law that requires the \$12 billion backing which actually a person cannot get—you cannot take your dollar and exchange it for gold, but use that \$12 billion free reserves for payment in the international field. Would this be a solution to the problem?

Mr. BARGER. It would certainly improve our position for the time being. I would certainly agree with Dr. Heller's view that the present percentage reserve requirements of gold certificates against Federal Reserve notes and deposits are entirely anachronistic.

Mr. BROCK. Would it solve the problem, basic problem, to just free this \$12 billion or is other action required?

Mr. BARGER. That requires a degree of crystal gazing which I am scarcely—I would say there are optimistic features in the present situation, not only the slight improvement in our own balance in the last year, but as I stated, the fact that Mr. Martin's monetary policy has kept wages and prices relatively stable in this country at a cost, in terms of slack in the economy, at a time when prices and wages in Western Europe and Japan are unquestionably rising at a rapid rate; and it may be that those countries will bail us out, in which case clearly our problem may yet be solved in that fashion. But personally, I hate to be a Mr. Micawber.

Mr. BROCK. Well, we are in a rather difficult field.

On another matter, Professor Robertson, you make a statement here on page 4, in which you state :

If we could reestablish the discount rate as a genuine money market rate and not just as a psychological indicator of central bank policy—the several regional banks might once again serve an effective role in matters of monetary policy.

How would you effect the reestablishment of a rediscount rate?

Mr. ROBERTSON. Well, I would say first of all that simply by taking thought we frequently do not achieve results that we would like to of the discount rate as a really effective weapon, and I am not sure that I could assure any mechanism for reinstating the rate.

I would begin, though, by rescinding regulation A in its present form and substituting a simple paragraph or two, in which permission would be given member banks of the System to borrow at the discount rate from the Reserve bank of the district, simply upon the presentation of proper collateral.

Mr. BROCK. Could I interrupt you?

Are you endorsing Chairman Martin's request that we broaden the definition of eligible paper?

Mr. ROBERTSON. I think I would go further than that. In actual practice the eligible paper question isn't so important any more, simply because rediscounting of paper is no longer important. Partly, of course, rediscounting is not important because the whole mechanism of the discounting windows has fallen into disuse. But actually, an advance with Government securities as collateral is the common way of obtaining credit at the discount window, and I should say that removing the restrictions on eligibility of paper would not be crucial in increasing member-bank access to Federal Reserve credit. What is crucial is the rule against continuous borrowing of the several Reserve banks, continuous borrowing being variously defined in different Federal Reserve districts. I feel that the banks in this country should look upon the discount window as a routine way of adjusting routine positions. The fact that it is not so regarded is testified to by the development of the Federal funds market. Now, I feel that the discount rate should be a genuine money-market rate—one that might ride above or below the bill rate but that would in any case move frequently. I would like to see the classical discount mechanism re-instituted so that a rise in the rate would discourage and a drop in the rate would encourage member bank borrowing.

The advantages of reinstating this system are that we then get from the private business sector advice that we do not now get. In short, I feel that the injection of reserves should be at least in part on the instance of the commercial banks rather than simply on the instance of the vice president of the New York Fed in charge of the trading desk.

Mr. BROCK. To accomplish this goal, would you not have to decrease the Open Market Committee operations? They are the field in which you govern money markets—govern money market rates today.

Mr. ROBERTSON. That is correct.



Mr. BROCK. You are going to either slow them down or discontinue them?

Mr. ROBERTSON. No, sir; I would not want to discontinue them. I would not foresee under such a system the removal of the Open Market Committee or of open-market operations. The Committee's chief function would be to make basic reserve injections to secure increases in the money supply over time. That is to say, it would not be concerned with the minute-to-minute feel of the marketplace. We see so much reference in the reporting of monetary decisions to "seat-of-the-pants judgment" or "leaning against the winds" of inflation or, to use a particularly vulgar expression that is appearing more and more, the "gut feel" of the Fed. This language is ridiculous, it seems to me. I feel very strongly that the Board of Governors and the Federal Open Market Committee should have an eye not to minor day-to-day adjustments but to major seasonal and secular movements. I feel that no one man or no group of men can inform our judgments as well as the marketplace can, and I see no reasons, either in history or in current money-market practices and institutions that would preclude this possibility.

Mr. BROCK. My time has expired. I would like to pursue this.

The CHAIRMAN. Mr. Vanik?

Mr. VANIK. What kind of policy, Professor Robertson—what effect would this have on interest rates?

Mr. ROBERTSON. Well, there would be two possibilities, would there not? I think you have in mind that rates would fluctuate more on a daily basis than they do under present institutional arrangements.

Mr. VANIK. They would be up and down all the time.

Mr. ROBERTSON. I am not sure this follows, sir. I can see nothing in the use of the discount window on a free basis that would necessarily give us greater volatility of rates, because I insist that, if there should be monetary stringencies developing that are not simply the result of day-to-day movements of routine factors affecting reserves, the Open Market Committee would stand ready to intervene.

Mr. VANIK. This would create or tend to create more chaos in the interest rates than ought to.

Mr. ROBERTSON. I am not sure that I see why.

Mr. VANIK. You would be diluting in effect some of the central decision, is that what you suggest?

Mr. ROBERTSON. No, sir; I would not be diluting the effect of central decision. I would simply make central decisions based on more information from the banking and financial community than is presently the case.

Mr. VANIK. You suggest more than an infusion of information. You suggest the allocation of authority in monetary matters to these local areas.

Mr. BARGER. May I add a word there?

I think my own feeling is that the discount window should be kept for the elimination of regional and local temporary shortages of reserves. But I personally would regard open-market operations as

the prime method and the only proper method of regulating the reserve base, total reserve base for the Nation as a whole. I think Mr. Robertson, in the profession as an economist, is in something of a minority here. I think the prevailing view would be that the discount window should be kept for the situation where the shoe pinches at particular banks or in particular local regions; and that the thing to regulate from the public standpoint is the reserve base and to let it grow at whatever rate it should grow; and this should not be done through the discount window.

Mr. VANIK. On that very point, it does concern me as to how many members there are on the Board or who participate in the policies which emerge from the Open Market Committee. I am more concerned about the body of administrative law which governs the action of these agencies. But I am concerned about the development of a real format or a body of regulations for the Fed and for the Open Market Committee of the Fed which would tell us how they are to operate. The work of the Fed would be more or less concentrated on developing a regulatory process out of which decisions could be machined out rather than left to the caprice or arbitrary judgment of people who are sitting on the Board and making unguided decisions or decisions that are not within the framework of regulations. What could you say about that?

Mr. BARGER. I would say that caprice is scarcely the word to describe the behavior or attitude of the Board within at any rate the recent past.

Mr. VANIK. I think it is caprice. For example, when policies develop which raise interest rates to curb inflation, I see the effect of it as adding to inflation when people have to pay more interest on the consumer items—they have added to the purchase price of it. It is inflating the cost of money which is tacked onto every purchase we make.

Mr. BARGER. The object in any case is to restrain spending, whether or not the total cost of a consumer good purchased on credit goes up. The main thing is to restrain demand.

Mr. VANIK. Do you believe that is a tenable point, to hold back on spending at a time when prices rather than spending, is really the problem?

Mr. BARGER. At the present time I think it is regrettable—perhaps a regrettable necessity that interest rates are as high as they are. I would want to see lower interest rates. I know the chairman would. I expect you would, sir.

But I refer to the foreign balance as a restraint at the present time. In the abstract, as a matter of principle, it seems to me that the function of the Reserve is to create so much purchasing power as will secure close to full employment, 3 percent of unemployment, or whatever you please; and at the same time not create so much purchasing power that we have an upward bias in wage rates and prices, and so forth. I think, sir, I find the word "caprice" not wholly appropriate in this connection.

Mr. VANIK. Would you tend then to feel that the Fed's policies in recent years have not contributed to unemployment?

Mr. BARGER. I think they have contributed to unemployment.

Mr. VANIK. If they have contributed to unemployment then they have failed us, have they not?

Mr. BARGER. I think that the Reserve has been hamstrung by an overriding requirement that it should keep interest rates high enough to prevent gold losses. I explained in my statement, and in answer to Mr. Brock's question, that I think the hands of the Fed have not been free; but in normal times if this constraint were removed, I think there are perfectly good statistical and other criteria for deciding what monetary policy should be in the light of the objectives I just mentioned.

Mr. ROBERTSON. May I make a comment, sir?

I would have one reservation here. The greatest restraints were placed on the economy by the monetary policy in effect from 1955 to 1960. Taking the period since the accord we find that the rate of growth of the money supply from 1951 to 1963 was approximately 2.2 percent per annum. That the recession of 1957-58 was not necessarily induced but was brought on more sharply by an unnecessary tightening of interest rates in the late summer and early fall of 1957.

Mr. VANIK. You assign error to the Federal Reserve's policy?

Mr. ROBERTSON. Yes; I would, especially in 1959 and 1960. In these years, although we were beginning to feel some international constraints, the international gold flow problem was not yet a major problem. I feel that the Fed was bringing about high rates in that period for purely domestic reasons, and I don't think that we can let the Fed off the hook by saying they were required at that time to put a stopper on the gold flow.

Mr. VANIK. What rule or what rule of thumb or regulation would determine the allocation of priorities as to which takes precedence, the gold flow or full employment? How do we arrive at which one first?

Mr. BARGER. Well, sir—

Mr. VANIK. This is a matter of caprice now, is it not?

Mr. BARGER. President Kennedy, President Johnson, and Secretary Dillon have made it very clear.

Mr. VANIK. They do not have anything to say about it, do they? This is an independent agency making that decision.

Mr. BARGER. No, sir; I would not regard it—

Mr. VANIK. They might read the President's speeches.

Mr. BARGER. I would not regard the Reserve as independent in that sense. I think if it permitted a policy which led to large gold outflows and a run on the dollar, the Federal Reserve would be grossly delinquent. In that sense I don't think the Federal Reserve can be considered independent or should be.

Mr. VANIK. You did not answer my question. I want to know how the priority would be determined. You have indicated what the thought was or what you thought the priority would be. How can we be sure by any rule of precedent, by any regulatory basis, how can we have any ideas as to which would take priority?

Mr. BARGER. The position of the administration is that the gold flow and the balance of payments should take priority and while that would not be my judgment—

Mr. VANIK. I have not seen that written down anywhere. I have not seen it anywhere where the administration said when it comes to deciding between full employment or curbing unemployment and limiting the gold flow that we are going to favor limiting the gold flow. If you had seen it I would like to have you spell it out for me.

Mr. BARGER. I would quote the statement of the late President Kennedy if you like, at the time that telstar was first launched, when he said that the one thing, whatever else the United States did, the one thing that it would never do, would be to devalue the dollar. If that is not a categorical statement of priority, I don't know what is, sir.

Mr. ROBERTSON. Just before devaluation it is customary for the authorities in any country to insist that devaluation will never under any circumstances occur. But I would like to go on from this point.

I would like to testify that, although I may be in a minority with respect to the question of freeing up the discount rate, I think both Professor Barger and I agree with the overwhelming majority of the economics professors in our views that domestic matters should take precedence over foreign in any handling of the money markets and in any engineering of interest rates, and I certainly would want to be on record as saying this. Most of us who are now middle aged—who came of age in the thirties—thought that once and for all we had severed the connection of the domestic economy with other economies, because we thought we had done away once and for all with an international gold standard. As it turns out, we had not. The United States, it seems to me, is going to have to take steps to remove its obligation to play the international gold game, and I am afraid, sir, that monetary policy alone can never, never adjust gold flows. I give you as one example the effectiveness of the so-called interest-equalization tax, which did more at one stroke to stop international gold flows than raising the interest rate by 2 full percentage points would have done.

Mr. VANIK. That is correct. I want to say that I see nothing in the Full Employment Act that relates anything, any of its objectives, to the gold flow. Perhaps at the time the act was adopted in 1946 this was not comprehended as a problem.

But the law still stands. Also I want to say I don't think the telstar statement Professor Barger mentioned meant President Kennedy gave priority to stemming the gold outflow over achieving full employment. I think he meant we'd defend the dollar with policies like the interest equalization tax.

Mr. ROBERTSON. If you will notice, to give one bit of testimony on Mr. Barger's comment, the new edition of the "Federal Reserve System: Purposes and Functions" (the little paperback that the System gets out every few years, a useful little book if you don't mind a lot of propaganda mixed in with the literature) for the first time states as one of the aims of monetary policy "longrun balance in our international payments"; it is implied that regulation of the gold flow is a part that no central bank should try to engineer; if we begin to is a part of System functions. In my view this is a matter that no central bank should try to engineer; if we begin to tie our monetary policy to the requirement of a gold reserve then we ought to have our heads examined.

Mr. BARGER. If you are looking for this, Mr. Vanik has only to consider the requirement that Federal Reserve notes and Federal Reserve deposits shall be convertible into gold certificates. And this together with the 25-percent reserve requirement seem to me already to place an obligation upon the Federal Reserve authorities.

The CHAIRMAN. Mr. Hanna?

Mr. HANNA. Thank you, Mr. Chairman.

First of all, I would like to say that if I understand the statement of Professor Robertson relative to the discount window I want to go on record as supporting his view. Because it is my understanding of his position, Mr. Chairman, that it was the discount window—that it was very valuable, although recently an unused tool for responding to the day-to-day shifts in our economy—if this is the correct view I am strongly in support of it. Because since I have been on this committee it has been suggested that the Board would be doing the local bankers a great—a great service, we would be getting back to one of the touchstones of our economy and let the market of itself play in these day-to-day shifts and take from that play then the large tones, that the obligatos be played over in the various districts and get the major theme and chords then reverberating to the Board and let them make the policy on that basis. They are knocking off bubbles of so-called baby moons, but taking a real sounding from the area of the operations within the district banks and giving some sense for having the district banks in the first instance. Is that the position of the gentleman?

Mr. ROBERTSON. This is my position, that the Federal Reserve bank in Dallas, Kansas City, St. Louis, San Francisco, or whatever it is, should be prepared to meet the demands for reserve credit at a rate, at the published rate. I am not going to get into the question of differential rates. I feel that, as Professor Barger suggested, this should be our approach to reserve adjustment outside the money market center of New York, and you have simply restated the view I hold, that the Open Market Committee in New York would not be precluded from an operation every day, but that, in general, it would not feel required to be on the phone calling all the dealers, checking with the banks, or making a phone call to St. Louis or elsewhere as a gesture toward checking the country as a whole.

Instead, the money market through the banking system should be allowed to make its own minute-to-minute and hour-to-hour adjustment, and open-market operations should be aimed at a per annum increase in the money supply, made on the basis of a total judgment regarding the economy. I wish I could say that it should be 3.5 or 4 percent. But I must confess that I don't know by what touchstone we would seize a single figure.

Mr. HANNA. I think that is true and I would not want us to suggest any magic percentage. I think it has to reflect a judgment based on appropriate factors and we should see that it is appropriately set up and carried out to show this responsibility.

Professor Barger, do you see any real violence down to the Open Market Committee in the establishment of sensible monetary policy by allowing the discount windows to operate in the fashion I have discussed with Professor Robertson?

Mr. BARGER. No, sir, I agree with what you and Professor Robertson said; that is, I remarked that the discount window should be thought of as a remedy for the shoe that pinches. And outside New York for individual banks obviously it has great value. But I still feel that the determination of the reserve base should be carried out through open-market operations. And I may say not, Mr. Chairman, through changes or in the lowering of reserve requirements.

Mr. HANNA. I would thank the gentlemen for making this clear. Because I have the feeling that if we do not change in many directions or in a direction that has been suggested, that because the private's shoes pinch we might have to change the shoes on the whole platoon. Certainly if the sergeant's shoe pinches, then certainly we would without question change the size on the whole platoon. It would be in the New York area.

Mr. BARGER. I would think that the borrowing of reserves is an improvement in the use of funds and a valuable substitute for the discount window. It is a supplement to the discount window, let us say, and I don't see any reason to regret the rise of the Federal funds market.

Mr. ROBERTSON. I do not regret it. I have no objection to it for this is the way the American business system traditionally responds to any problem. It is a marvelously inventive system; the Federal fund market is an invention brought about by the inhibition placed on member-banks borrowing by the arbitrary rules laid down in regulation A.

Mr. HANNA. I would like to make one other point this morning which has been brought to the surface of my thinking from the questions we have had had here and that is that I think we should distinguish between the factors to which responsibilities must be responsive and factors over which responsibility has authority.

Now, I say that because ever since—it was quoted yesterday—the remarks of Mr. Balderston bothered me, taken out of a speech made by the Vice Chairman at Georgia State College in Atlanta on February 13, 1964, to this regard.

The role of general monetary policy is to regulate the reserve available to commercial banks so as to promote economic growth, high levels of employment, reasonable stability in prices and to aid in achieving equilibrium in our balance of payments. It is this responsibility so vital to the protection of integrity of the dollar that has been delegated by Congress to the Federal Reserve System.

Now, I wonder if you gentlemen agree that this has been, this strict delegation of authority to the Federal Reserve?

Mr. BARGER. Yes, the objectives would appear such as at present to be incompatible. Maybe you cannot do what you want to do about growth of the economy, or employment, and at the same time handle the foreign balance situation.

Mr. ROBERTSON. I would say that this is a rather typical presumption of the central bank, that it is responsible for these admittedly admirable goals.

Mr. HANNA. Let me put it this way, Professor Robertson and Professor Barger, if you will listen.

Supposing the statement had said the role of general monetary policy is going to regulate or is to regulate the reserves available to commer-

cial banks so as to be responsive to the desirability of economic growth, high levels of employment, et cetera, et cetera. Does this do violence to what—in other words, to say that we have given this authority over these fields seems to me is going further than the Congress has ever gone.

Mr. BARGER. "Authority" is an unfortunate word. I don't believe there is any disagreement between you, us, and Mr. Balderston.

Mr. HANNA. This is the way you would interpret his remarks?

Mr. BARGER. Certainly.

Mr. HANNA. That they are to carry out the responsibility of monetary policy in a manner which is responsive to these particular factors?

Mr. BARGER. Certainly, with the thought in the back of my mind that they may not be compatible at all times, the objectives.

Mr. HANNA. I think we discussed that in terms of trade offs which go on all the time. I think this is what bothered Mr. Vanik. I do not think there is ever going to be a set pattern, a set mechanical process by which you can predict this; is that right?

Mr. ROBERTSON. Right here we come to my basic reason for insisting that the Secretary of the Treasury and a member of the Council of Economic Advisers should be on the Board of Governors ex officio. I feel that the central bank should have the participation in its regular councils of other agencies responsible also for the achievement of these admirable goals, and I feel that weekly luncheons at the Treasury or luncheons of Treasury officials in the Fed dining room are not enough to insure the kind of unified, consistent policy that we should have. Formal communications should be established among the Federal Reserve, the Council of Economic Advisers, and the Bureau of the Budget, and Federal Reserve and Treasury should invariably operate to further the total economic objectives of the administration in office. At the same time I am reluctant to say that we should make the central bank a bureau of the Treasury.

Mr. BARGER. May I speak to that point? Professor Robertson is anxious that the advice of the Secretary of the Treasury and others should be available to the Reserve Board in its Board room. I might say in parentheses, I was altogether delighted with Professor Robertson's support for university economists as advisers to the Board. In the past we have had some very eminent men in that capacity, such as Alvin Hansen and John Williams, of Harvard, and many others. But advice as I see it is something that should be given outside the Board room, and to introduce the Secretary of the Treasury into the Board room seems to me to give him a decisionmaking function which is not appropriate, and I would like to say a word further about that, if I may.

It is correct that the practice in many other advanced nations, as in Western Europe, is for the central bank to be subject or subservient—to be the creature of the Secretary of the Treasury. But our Treasury is a very peculiar Treasury, Mr. Chairman. It has few of the functions that are normally assigned to treasuries in other countries. It does not draft tax legislation. That is the function of committees of Congress. It has little or no responsibility for public expenditure

which is exercised by other committees of Congress, together with the Bureau of the Budget. And it could almost be said with truth, that the function of the Treasury of the United States is practically confined to the management of the public debt. Now, sir, we had a long history during the 10 years prior to the accord of 1951 in which the Treasury showed a single-minded concern for the cost of the public debt, and pressed the reserve for the lowest possible interest rates, even though these might tend toward inflation. I conceive that owing to the lack of concern of our Treasury, for historical reasons, its lack of concern with fiscal policy at large, with spending and taxing, and its concentrated concern with the public debt, the Secretary of the Treasury is not a suitable person to be a member of the Federal Reserve Board.

Now, Professor Robertson had a way around. He said, well, of course, we might bring into this some others with different concerns, different responsibilities. So let us have the Chairman of the Council of Economic Advisers, let us have the Director of the Bureau of the Budget, also as members of the Federal Reserve Board. Well, sir, it seems to me you end up with a Federal Reserve Board which is a collection of all the talents and all the viewpoints, and which is going to find it impossible to agree upon any single policy. Thus indecision, which to my mind has been the cardinal sin of the System, will be aggravated to a high degree.

I believe that the coordination of Federal Reserve policy with other parts of Government policy should be handled through the White House. To my mind there is no escaping this conclusion. That is to say, if the President feels that there is lack of coordination of Reserve policy with Treasury policy or Bureau of the Budget policy, and that it should be different than it is, then it is up to him to say so. That is why I am opposed to the provisions of H.R. 9631 which would put the Secretary of the Treasury on the Board, but I would favor on the other hand an arrangement whereby the terms of the Reserve Board members would be made to begin in odd years rather than even years, so that a new President could appoint at least one member and so that he could appoint his own chairman.

The CHAIRMAN. I want to comment on some matters and ask a few questions.

No. 1, I certainly appreciate the testimony of you gentlemen, although you do not agree with me on many of the proposals, which is all right. We have, it could be said, two people here and whenever two people always agree and have the same thinking, one of them at least is doing a part of the other's thinking and I do not expect people to agree with me every time. It is understandable. That is the reason we have a good country. We fight them out in our fair, democratic way, and the majority rules, and the majority is usually right. If the majority is not right, corrections can be made.

You have given us some very interesting testimony, each one of you gentlemen. It certainly will be considered and will be helpful to us in the consideration of these matters.

I am impressed, gentlemen, that the Federal Reserve has changed in such a substantial and about-face direction, that I wonder if we can just justify any further existence of the present Federal Reserve System as such.



We have about 20,000 employees in the Federal Reserve and the testimony shows that about the main thing that they are doing is servicing the member banks individually and that not to any great extent, and clearing checks. If you take the clearing of checks away from them and the dispensing of money and credit and things like that, you have not got anything left.

The discount windows are practically closed. At the beginning, in 1914 when the banks were set up, the discount windows were the most important places in the Federal Reserve System. And it was about the only source of revenue for the System. Eligible paper was rediscounted with the Federal Reserve and then when the eligible paper became due it was sent to the bank and the bank would do the collecting and send the money back to the Federal Reserve. It served a very fine, useful purpose, and there was some incentive for a local banker to deal with the small businessman or a farmer. They had something to gain. They could take the paper that they received from this farmer, or small businessman, put it up with the Federal Reserve and get high-powered dollars, dollars that the banking system could expand on 10 to 1, sometimes more than that. But when we got away from eligible paper, these bankers became less and less inclined to even see these small business people and these farmers who need credit. They have to deal with too many of them to do a substantial amount of profitable business and they have gotten away from it. And, of course, the farmers have had to go into the Farmers Home Loan Administration and the small business people have had to ask Congress to take care of them by creating special loan agencies because banks have just fallen down on that particular job. That is the reason I look with great reluctance on supporting expanding opportunities for banks to get into more and more outside paper.

Why should we let banks get away from their local communities? If the banks had supplied the local merchants with credit when the absentee chainstores spread over the country the local people could have survived. They could have saved their businesses and could have helped everybody in their community. But by not getting this credit when the absentee-owned chain came in, established shopping centers and things like that, the little fellows without adequate credit were just unable to meet competition. Therefore, we have most of our little towns now filled up with absentee businesses, the profit from which go to New York, Chicago every night. It hurts a town greatly, adds to the unemployment problem. People who are independent local merchants—they are not directors or members of the board. They have all been merged and go to the cities and the country people in the small towns have been placed in a minor role and almost impossible situation as far as taking care of themselves are concerned.

I feel like the banks have been going too far in the direction of speculation and profit and not thinking too much of the public good and the good of the country. So in doing that, the Federal Reserve has gone out of business. The Federal Reserve banks used to be self-sustaining and made a pretty good profit on the discount window and the loans they made and rediscounts that were granted—but now, 99 percent of their profits, their money comes from that New York Federal Reserve Bank. They do not touch it and they never see the bonds that earn the money that the taxpayers pay to them in interest every

year. But they get their share. They do not earn it. It is unearned. They just get it, that is all.

Under this system they get it and they are not earning anything for it now. They are engaging in such activities as trying to locate plants in the area, manpower retraining, mass transit problems, tourist promotion, they get involved in adult education and just plain old propaganda. They seem to be trying to justify their existence. They are certainly not doing a job.

It occurs to me we could well afford to just say we have got to repeal this whole thing, start from scratch; immediately enact a law that would have a good Federal Reserve Board acting in cooperation with the Secretary and President and get the job done that does not cost near as much and it would be a lot better for the American people. We don't need the Reserve banks.

What do you gentlemen think about that suggestion for consideration?

Mr. BARGER. Well, sir, may I say a word?

I think that the first requirement is to provide the local banks with an adequate reserve for lending and certainly I am sympathetic to the idea that the types of assets they should hold should be restricted, so that they can be encouraged to satisfy the needs of local business. I think that is well taken.

On the other hand, sir, I would say with the greatest hesitation that I feel you misconceived to some extent the function of the Federal Reserve which, as I conceive it, is to determine the reserve base, and the rate at which the money supply expands; and it would be difficult for the Reserve System or Reserve banks to be concerned with the lending practices of individual banks in country districts, for example.

The CHAIRMAN. Could the Board not do that, Professor?

Mr. BARGER. What could the Board do to encourage lending to business in areas where banks prefer to hold municipal bonds?

The CHAIRMAN. Practically all business of the Fed now is the business of the Open Market Committee. The Open Market Committee conducts most of the business of the Federal Reserve. This Board that I am talking about could still carry on the open-market operations.

Mr. BARGER. But all the Board can do is to make sure that the banks at large have the base on which to acquire assets, and if they prefer to acquire municipal bonds or Treasury obligations rather than make loans to private businessmen, I think this is regrettable, but I don't see what the Federal Reserve itself can do about it. I think you may make regulations regarding the assets that banks can hold and so forth, but I feel that the blame should not be placed upon the Reserve. I am very critical of the Reserve in many respects, but I feel this particular approach is not with justification, sir.

The CHAIRMAN. What do you think about it, Professor Robertson?

Mr. ROBERTSON. In the first place, I feel we must consider the contribution of Federal Reserve and the commercial banks to a smooth-working system of interregional payments. I think, Mr. Chairman, I would disagree with your view that the so-called service functions are altogether unimportant. After all, there is a cost involved in the collection of checks, and the public question, the historic question, is how can we, with the least disruption to the private sector, effect these

payments both on private and Government account. I feel that we have developed a system that works very well indeed, and I am reluctant to change it.

With respect to the decline of the small business, in the small community, I certainly am sympathetic to the problem.

I came from one of the 100th meridian States, where I could see almost year by year the decline of the small town. Some of the places that used to be towns have actually disappeared out in Kansas where I grew up, and I confess that I hate to see the old order pass. At the same time I am afraid it is essentially the problem of the decline of agriculture in those areas rather than a fault of the banking system. I believe we would find that the country bank has been on the whole helpful to the local communities. Indeed, I have a very high regard for the commercial bankers in general, both small and large, as being contributors to the progress of the country.

It is a question as to whether banks are inordinately profitable or not. The latest FDIC figure that I have shows that they make a return of 8.5 percent on all their capital accounts. I have a hunch, Mr. Chairman, that this is not an inordinately high figure compared with true public utilities on the one hand (and some people might argue that a bank should be considered as a public utility) and both industrial and commercial concerns on the other.

I do not see any evidence of inordinate profits, and we find that the smaller banks tend to be on the underside of the average figure I just quoted. So that, although it is a question of judgment, and I cannot in some sense prove that I am right on this point, I would recommend to this committee that it move with some care before bringing about any sharp changes in these institutional arrangements. Some changes are needed, and I would not deny the need for a moment. I simply feel that in the world of finance we have to move with some caution.

The CHAIRMAN. I am impressed with what you say and I am not advocating this. But I am greatly concerned about the way the System has deteriorated.

We have 12 banks, but all the books are kept in New York. They kept the books for all 12 banks. They tell them every day how much money they get, assets and everything else.

Mr. ROBERTSON. Yes, on a pure quota system. The reason for this arrangement is that we have centralized all the functions of the central bank except the service functions, which are of course being performed in St. Louis, Dallas, San Francisco, and the other Federal Reserve banks to a greater volume than ever before.

Mr. BARGER. You say the decisions are made in New York? This is news to me. I thought they were made in Washington where the Board and the Open Market Committee meet; and if the decisions are not made in Washington, they should be.

The CHAIRMAN. I know it. I agree with you. But the decisions are made here every 3 weeks and carried out in New York by whom? By employees of the Federal Reserve Bank of New York who are not under the direction of the Board. By law they are under the direction of the president of that bank.

Mr. BARGER. That is why I supported your proposal that the functions in relation to credit regulation and monetary policy should be transferred from the Federal Open Market Committee to the Board.

The CHAIRMAN. Yes, sir; that is what I want.

Now, Professor Robertson, the banks I think are public utilities. They have to get a charter. They have an exclusive franchise and to that extent they can be looked upon as being public utilities. But that is unimportant to this discussion.

Now, the Federal Reserve has always claimed that part of their existence was justified because of needing a smooth operating money market and not having any disruptions in the flow of money and credit. They brag about how they prevent disruption all the time. But now then they take the other side. They say we have to let the banks have these tax and loan deposits, averaging \$5.3 billion last year. If this money had been paid into the Treasury it would have saved the taxpayers over \$200 million and the Treasury's justification for not doing that is to stop disruptions in the flow of money and credit. They have taken that function away from the Federal Reserve. So the Federal Reserve soon will not have much left to do. That is one of the main things that the Fed was supposed to do, prevent disruptions in the flow of money and credit.

Mr. ROBERTSON. If I may say, Mr. Chairman, part of the lack of disruption is attributable to the system of calling from the tax and loan accounts, from the A, B, and C banks, in a way that can be metered by the Treasury. I would like to point to what seems to me a demonstrable advantage, the lessening of the impact of Treasury receipts and withdrawals upon the reserves of the banking system.

The CHAIRMAN. But this puts us in an undemocratic position. When we charge a person with not paying his taxes on April 15, we put him in jail or fine him. We are charging that man with failure to pay into a bank where he lives so the bank can use it indefinitely and make money on it. That is not a very good system.

Mr. Brock, did you have any more questions?

Mr. Brock. I do not want to take too much time.

I would like to pursue Professor Robertson's—this idea of yours on switching away from the Open Market Committee or at least reemphasizing the discount window. Are you in effect endorsing at least a modified version of this philosophy of Professor Friedman's in which he advocates a stable input into the total money stock by the use of the Open Market Committee and use it for that purpose alone?

Mr. ROBERTSON. Yes. I think it is a modified version. Mr. Friedman has made so many suggestions that it is a little hard to know exactly what his total system amounts to. But to be unequivocal, I would say that I feel reserve injections should be made in such a way as to achieve an increase in the money stock in any year. That does not just happen; it is the consequence of a predetermined decision. When the forecasts come out in December and January as to what kind of year we are going to have, I think that one of the projections that the Fed should make is the increase that ought to occur in the money stock. All variables should be taken into consideration—it is for this reason that I feel that the Fed should be relieved of the relatively minor money-market adjustments that go on all the time in New York.

It seems to me that minor reserve adjustments could better be left to the Reserve banks in the several districts, and all I am saying is that the Board in Washington could then take the information telegraphed to it by changes in member-bank borrowing to assist it in determining what kind of reserve injection or reserve absorption should be made through open-market operations.

I certainly want it clear that I do not mean to suggest that open market operations would cease to be a major instrument of control. In fact, under any conceivable arrangement made so far as the several Reserve banks are concerned, open market operations will continue to be the major form of reserve regulation.

Mr. BROCK. For example, he suggested that we have rather than making a year-to-year projection, that we have a flat rate of input and eliminate one of the variables in economic swings. Because he felt this was a factor which had in the past increased the severity of recession or inflation.

Mr. ROBERTSON. I feel this is too pat. It is too easy. For example, in this year, now that we have the reduction in tax rates, we would probably take a different view of what the rate of increase in the money stock should be than we would if as though the Congress had not passed this legislation. I would suppose that we would have a smaller increase in the money stock this year because of the tax reduction than we would have had the reduction not come into being.

In short, I don't feel that we must have a specified and unvarying monetary increase to accommodate a certain increase in the gross national product.

Mr. BROCK. I have been interested in your concept as a historian that we ought to revitalize the rediscount window and my understanding of it is that it has almost atrophied just because of the change in the money market conditions in this country. It has not been a deliberate thing that we do not use the discount window. It is just that the money structure—

Mr. ROBERTSON. Well, sir, it is my opinion that it was largely deliberate, and I would like to have Mr. Barger's view, whether it corroborates mine or not.

The restrictions placed on the discount window came about for two reasons. In the first place, the rediscounting of paper became a tremendous annoyance to the individual commercial banks because, when the discounted paper was sent back by the Reserve banks for collection, the farmer or small businessman would see from a stamp on the back that the paper had been sent to this ogre, this monster in the big city, and would get extremely excited about it. Moreover, during World War I member banks began the practice of obtaining "advances" on the pledge of Government securities as collateral and this method of borrowing at the Fed turned out to be more convenient than rediscounting commercial paper.

Then there were some instances of banks borrowing their reserves or even twice or three times their reserves—in short, borrowing low to lend high—that led to the feeling that discounting could be dangerous. I submit that this is a matter for bank supervision and not for central bank policy. I certainly can foresee that a free discount window would lead to some questions of bank supervision, but we surely have plenty of that in this country, far more, probably, than we need.

In any case, during the twenties and thirties we began to get a more and more complex set of regulations that led finally to the prohibition against continuous borrowing and ultimately to the decline of the discount rate as an instrument of monetary control. For the institutional details of present arrangements I would like to cite for your consideration an article by Professor Whittlesey that appeared in the *Quarterly Journal of Economics* a few years ago.

The CHAIRMAN. You may insert it.

(The document referred to may be found in the appendix on p. 1525.)

Mr. ROBERTSON. I would like to go back and brush up a little bit on this. It is my strong opinion that the discount windows are closed by the Fed through regulation and not by either law or by tradition.

The CHAIRMAN. Mr. Barger?

Mr. BARGER. The decline of eligible paper was due to certain institutional changes, particularly the improvement of communications, but the decline of borrowing by member banks was essentially due to the vast excess reserves of the 1930's and 1940's. Borrowing was revived after 1951 and there is no reason it should not have an important future.

The CHAIRMAN. Thank you, gentlemen, very much. This will conclude our hearings this morning and we will adjourn until tomorrow at 10 o'clock.

Mr. BARGER. Thank you, sir.

Mr. ROBERTSON. Thank you, sir.

The CHAIRMAN. Thank you, very much. Because of the concern expressed at these hearings today and earlier about the Federal Reserve's supposedly having to follow a tight and insufficiently expansionary monetary policy in order to satisfy the gold certificate requirement, I am putting into the record at this point a letter Chairman Martin wrote to Senator Douglas on this matter. The letter indicates the problem is really one of form, not substance.

(The information referred to follows:)

BOARD OF GOVERNORS  
OF THE FEDERAL RESERVE SYSTEM,  
*Washington, November 5, 1963.*

HON. PAUL H. DOUGLAS,  
*Chairman, Joint Economic Committee,  
Washington, D.C.*

DEAR MR. CHAIRMAN: This is in reply to your letter of October 21, 1963, in which you asked for certain information regarding the 25 percent gold certificate reserve requirements specified in section 16 of the Federal Reserve Act, with particular reference to action the Federal Reserve might take if the reserves should fall below the required amounts.

Paragraph 3 of section 16 provides that each "Federal Reserve bank shall maintain reserves in gold certificates of not less than 25 per centum against its deposits and reserves in gold certificates of not less than 25 per centum against its Federal Reserve notes in actual circulation." The Board of Governors has authority, under section 11(c) of the Federal Reserve Act, to suspend these requirements in order to provide time for corrective adjustment, should the reserves fall below required levels. Section 11(c) also requires the Board to impose a graduated penalty tax on Reserve banks experiencing a reserve deficiency. The Board could comply with this requirement by imposing a nominal penalty tax, so long as System holdings of gold certificates did not fall below 20 percent of Reserve bank liabilities on Federal Reserve notes outstanding. For any

deficiencies of reserves below this level, the law requires the imposition of a tax graduated upward from  $1\frac{1}{2}$  percent per annum. The discount rate of any Federal Reserve bank so penalized would have to be raised correspondingly. The text of section 11(c) follows:

"Sec. 11. The Board of Governors of the Federal Reserve System shall be authorized and empowered—

\* \* \* \* \*

"(c) To suspend for a period not exceeding thirty days, and from time to time to renew such suspension for periods not exceeding fifteen days, any reserve requirements specified in this Act: *Provided*, That it shall establish a graduate tax upon the amounts by which the reserve requirements of this Act may be permitted to fall below the level hereinafter specified: *And provided further*, That when the reserve held against Federal Reserve notes falls below 25 per centum, the Board of Governors of the Federal Reserve System shall establish a graduated tax of not more than 1 per centum per annum upon such deficiency until the reserves fall to 20 per centum, and when said reserve falls below 20 per centum, a tax at the rate increasingly of not less than  $1\frac{1}{2}$  per centum per annum upon each  $2\frac{1}{2}$  per centum or fraction thereof that such reserve falls below 20 per centum. The tax shall be paid by the Reserve bank, but the Reserve bank shall add an amount equal to said tax to the rates of interest and discount fixed by the Board of Governors of the Federal Reserve System."

This suspension authority, together with the penalty tax provisions, was part of the original Federal Reserve Act, as enacted in 1913, except that in the original act the reserve requirements were 40 percent against notes and 35 percent against deposits, and the higher tax rate became mandatory when a Reserve bank's reserve against notes fell below  $32\frac{1}{2}$  percent. The reduction from a 40-percent requirement against notes and 35 percent against deposits to 25 percent in each case was made by the act of June 12, 1945 (59 Stat. 237). Since you have expressed an interest in the origin of the gold cover requirement, I am attaching material on its legislative background and intent prepared by our staff.

The Board has exercised its authority under section 11(c) to suspend reserve requirements on three occasions. On November 7, 1919, the Board authorized Governor Harding to suspend reserve requirements of the Federal Reserve Bank of New York for a period not exceeding 10 days. On March 15, 1920, the Board suspended reserve requirements for all Federal Reserve banks for 10 days. On March 3, 1933, the Board suspended reserve requirements for all Reserve banks for 30 days. None of these suspensions was renewed.

Penalty tax rates have been established at varying levels over the years under section 11(c). They have always been graduated according to the size of the deficiency, but three different beginning rates have been fixed. From the inception of the System until 1933, the rate on the first 5 percentage points of deficiency in reserve requirements was 1 percent per annum. On March 13, 1933, the Board cut the beginning rate to one-tenth of 1 percent per annum. This rate prevailed until June 30, 1945, when the Board adopted a higher rate schedule, following enactment of the legislation lowering reserve requirements to 25 percent. That schedule has continued unchanged up to the present time, as follows: One-half of 1 percent per annum when either the note or deposit reserve ratio falls to between 25 and 20 percent; 2 percent upon deficiencies below 20 percent down to  $17\frac{1}{2}$  percent;  $3\frac{1}{2}$  percent upon deficiencies below  $17\frac{1}{2}$  percent down to 15 percent; and an additional  $1\frac{1}{2}$  percent for each  $2\frac{1}{2}$  percent further decline in either reserve ratio below 15 percent.

In round numbers, the System's gold certificate reserves stand at \$15 billion, to cover \$18 billion in deposits and \$31 billion in Federal Reserve notes. (A table is attached showing actual figures for October 30, 1963, but round figures will simplify the discussion at this point.) If there were a continued loss of gold reserves to the point where they were about to become insufficient to cover note and deposit liabilities (that is, if they fell from \$15 to \$12 billion), the Board could suspend the requirements to permit time for corrective adjustment. While the initial suspension is limited to 30 days, unlimited renewals are authorized and although no single renewal may be for more than 15 days, no overall limit is imposed on the duration of successive suspensions. If a reserve deficiency should prove unresponsive to corrective measures, the Board could, therefore,

continue a suspension for as long as necessary to permit enactment of remedial legislation.

As long as a reserve deficiency were confined to what we may call the first "layer"—the reserves required against deposit liabilities—the only action required by law would be the imposition of a tax against the Federal Reserve banks. Under a longstanding interpretation of section 11(c), the tax need not be added to the banks' discount rates until the reserve deficiency penetrates into the second "layer"—the reserves required against Federal Reserve notes. For the System as a whole, therefore, reserves could fall from their present level of \$15 billion to \$8 billion before any increase in discount rates would be required by the act. Under the present schedule of penalty rates, if reserves fell all the way through the first "layer" (down to \$8 billion), the annual taxes on the reserve deficiency (using \$18 billion as the figure for deposits) would be something under \$300 million a year. Payment of these taxes would diminish net earnings of the Federal Reserve banks and reduce by an equal amount their payments to the Treasury as interest on Federal Reserve notes, which amounted to \$800 million in 1962. It should be understood that the total payment to the Treasury would not change; it would simply be divided into two parts adding to the same total, one part labeled "tax on reserve deficiencies" and the other labeled "interest on Federal Reserve notes." In the example, the total payment would still be \$800 million, but \$300 million would be in the form of a tax and \$500 million would represent interest on notes.

If reserves continued to fall, so that a deficiency occurred in the reserve against Federal Reserve notes, with a consequent additional penalty tax for that deficiency, the statute would require the Reserve banks to "add an amount equal to said tax" to the rates they charge on advances to borrowing member banks. While the statute is not at all clear on the mechanics of imposing this added charge, perhaps the most reasonable method would be to raise the discount rate by the same number of percentage points as the penalty tax rate on the note reserve deficiency. For example, if the gold certificate reserves fell to 20 percent of Federal Reserve notes—or to about \$6 billion—the penalty tax under present rates for the note reserve deficiency would be one-half of 1 percent (or \$10 million). Adding the penalty tax rate to the present discount rate of 3.5 percent would result in a discount rate of 4 percent. Again, it should be understood that the Board could establish a different penalty tax rate in this case; the statute simply requires that it be "not more than 1 per centum per annum." The statutory minimum penalty tax rate would come into effect only if reserves fell below this point.

It seems reasonable to conclude that if this country's gold losses should continue to the point where the Reserve banks were unable to comply with the 25-percent statutory reserve requirement, there is ample authority under the present act to meet the situation without disrupting the economy or the international payments mechanism, and to provide time for Congress to consider legislative action.

In response to your question about the arguments for and against keeping the gold reserve requirement, I doubt that I can add anything more to the testimony your committee has already received. In my judgment, no change in the requirement should be undertaken at this time, because the risks of such an undertaking outweigh the benefits to be gained. The principal risk in such a move under current conditions is that the public might interpret it as a sign of weakness portending failure in the Government's efforts to maintain the value of the dollar. I see no need to run this risk, because the gold cover requirement does not pose any obstacle to the use of our gold reserves in defense of the dollar, and the best way to deal with worries on that score is to lay before the public a full explanation of what the statute requires and the procedures for meeting its requirements. I appreciate this opportunity to contribute to that end.

Sincerely yours,

WM. MCC. MARTIN, JR.



## ATTACHMENT A

*Application of Federal Reserve gold certificate reserve requirements, Oct. 30, 1963*

[In millions of dollars]

1. Combined Federal Reserve deposit liabilities.....	\$17,810
2. Combined Federal Reserve note liabilities.....	31,442
3. Total Federal Reserve liabilities subject to reserve requirements.....	<u>49,252</u>
4. Total Federal Reserve gold certificate reserve.....	15,310
5. Less 25-percent reserve requirement on Federal Reserve notes and deposits.....	<u>12,313</u>
6. Excess gold certificate reserves.....	2,997
7. Plus 25-percent requirement on Federal Reserve deposits (deficiencies in this requirement necessitate no discount rate increase)...	<u>4,453</u>
8. Total gold certificate reserve releasable without mandatory discount rate increase.....	7,450
9. Plus difference between 25- and 20-percent requirement on Federal Reserve notes (deficiencies in this range require only a small discount rate increase).....	<u>1,572</u>
10. Total gold certificate reserves releasable without substantial mandatory discount rate increase.....	9,022

## ATTACHMENT B

## LEGISLATIVE BACKGROUND AND INTENT OF GOLD RESERVE PROVISIONS OF FEDERAL RESERVE ACT

The House report on H.R. 7837, 63d Congress, the 1913 bill which became the Federal Reserve Act, contains the following statement regarding the purpose of imposing reserve requirements on the proposed central banks:

"In a general way the committee believes that requirement of a fixed reserve is not a wise or desirable thing as viewed in the light of scientific banking principle. It believes, however, that in a country accustomed to fixed reserve requirements the prescription of a minimum reserve may have a beneficial effect, \* \* \*."<sup>1</sup>

Since the "real bills doctrine" formed the theoretical basis for the original Federal Reserve Act, the members of the House Banking and Currency Committee evidently believed that limiting central bank credit expansion to the discounting of eligible paper would provide a sufficient check on monetary expansion, and that imposition of gold reserve requirements would be inconsistent with the "real bills" principle. However, because the precedents of reserve requirements for national banks and for various foreign central banks suggested that there might be a problem of public confidence, the committee members were willing to recommend gold reserve requirements. Other legislators, and the majority of the National Monetary Commission, were strong supporters of the idea that the central bank's liabilities should be restrained by the level of gold reserves.

According to the House report on H.R. 7837, the Federal Reserve Board's power to suspend reserve requirements was based upon a similar provision in the National Bank Act of 1864.<sup>2</sup> Under this latter provision the Comptroller was required to notify a bank with a reserve deficiency to "make good" the deficiency. If after 30 days the deficiency still continued, the Comptroller could, with concurrence of the Secretary of the Treasury, appoint a receiver to wind up the business of the bank.

<sup>1</sup> U.S. Congress, House Committee on Banking and Currency, "Changes in the Banking and Currency System of the United States," H. Rept. 69 to accompany H.R. 7837, 63d Cong., 1st sess., 1913, p. 71.

<sup>2</sup> *Ibid.*, p. 46. See sec. 5191 of the Revised Statutes for this provision in the National Bank Act of 1864.

Section 22 of H.R. 7837 was taken almost word for word from this section of the National Bank Act. Hence, in this early version of the Federal Reserve bill the Board would apparently have been required to close a reserve deficient Reserve bank and appoint a receiver therefor if such bank should fail to make good its required reserve after receiving 30 days' notice from the Board to eliminate such reserve deficiency.

In later versions of the bill, the Board's power to close a Reserve bank was replaced with the mandatory requirement to impose a graduated tax on any bank with a reserve deficiency. Such a change would seem to shift the emphasis of adjustment from the mechanism of temporary suspension of requirements to the process of tax and discount rate increases and consequent restraint upon monetary expansion.

The provision of a penalty for reserve deficiencies appeared to be drawn from European central bank regulation, most specifically the German control bank.<sup>3</sup> Inclusion of a penalty is confirming evidence that the congressional authors of the act were not prepared to follow unequivocally the "real bills" doctrine with its attendant implications that Federal Reserve discounting of "real bills" would automatically provide the "right" amount of money. This conclusion is a logical consequence of the provision which requires a reserve deficient Reserve bank to respond to the penalty tax by raising the interest and discount rates which it receives on such "real bills." The Congress evidently envisioned that the tax-induced increases in discount rates would reduce Federal Reserve credit, which, in turn, would eliminate the reserve deficiency while reducing bank reserves and the money supply.

The language of the act as enacted could be interpreted as suggesting that the effects of the penalty were expected to apply to individual Reserve banks, encouraging asset transfers or liquidation of liabilities only by the particular Reserve bank affected. Study reveals, however, that penalty provisions were included in early versions of central bank bills, including the Aldrich bill which proposed one centralized monetary institution, and hence there are grounds for presuming that the deflationary consequences of the penalty tax were expected to be nationwide in scope.

(Whereupon, at 12:10 p.m., the subcommittee was in recess, to reconvene at 10 a.m., Wednesday, March 11, 1964.)

---

<sup>3</sup> Owen, Robert L., "The Federal Reserve Act," New York, Century Co. (1919), pp. 12-14 and 19-24.



# THE FEDERAL RESERVE SYSTEM AFTER 50 YEARS

WEDNESDAY, MARCH 11, 1964

HOUSE OF REPRESENTATIVES,  
SUBCOMMITTEE ON DOMESTIC FINANCE OF THE  
COMMITTEE ON BANKING AND CURRENCY,  
*Washington, D.C.*

The subcommittee met, pursuant to recess, at 10 a.m., in room 1301, Longworth House Office Building, Hon. Wright Patman (chairman) presiding.

Present: Representatives Patman, Moorhead, Minish, Weltner, Kilburn, Widnall, Bolton, and Brock.

The CHAIRMAN. The committee will please come to order.

We have as our witnesses this morning G. L. Bach, Stanford University and Carnegie Institute of Technology and Prof. Abba P. Lerner, professor of economics, Michigan State University.

Mr. Moorhead, would you like to say a word?

Mr. MOORHEAD. If I may, Mr. Chairman.

The CHAIRMAN. Mr. Moorhead is a distinguished member of our committee. We would like to hear from him.

Mr. MOORHEAD. I would like to introduce to the committee Dean Bach of the Carnegie Institute of Technology which is in my congressional district. Although he is temporarily away at his Stanford post, we nevertheless consider him one of the leading citizens of our community and one of those economists who is respected by all shades of opinion for his wisdom and judgment.

I think the committee is very fortunate to have Dean Bach's testimony.

The CHAIRMAN. Thank you, sir.

Dean Bach, you may proceed first. You are first on the list and then after you conclude we will hear our other witness, Professor Lerner. If you want to read your entire statement, it is all right. You may insert it in the record and comment on it or proceed in your own way, any way you choose.

Dr. BACH. Mr. Chairman, I would like to read a reasonably brief statement and then perhaps insert the fuller version for the record.

The CHAIRMAN. That may be done.

## STATEMENT OF DR. G. L. BACH, STANFORD UNIVERSITY AND CARNEGIE INSTITUTE OF TECHNOLOGY

Dr. BACH. My statement is in three parts. First, I comment on the organization and structure of the Federal Reserve, with reference to the bills being considered by the committee. Second, I shall present some observations or procedures used by the Federal Reserve in its

policymaking, which are separable from the issue of the organizational structure of the System. And third, in accordance with the committee's request, I am glad to present my views on current monetary policy.

#### FEDERAL RESERVE ORGANIZATION

The organization of the Federal Reserve System today still reflects the outdated regionalism and fears of 50 years ago when the System was established. If we were to establish a central bank anew today, I would favor a substantially different, and simpler, organizational structure; with the central bank a purely public institution; with policymaking powers lodged in a smaller, completely appointive Board of Governors; with all special occupational and geographical qualifications for Board members eliminated and replaced merely by a statutory stipulation that members be positively qualified by experience or education and competence; and with all insured banks required to be members of the Federal Reserve System.

But the present system operates, on the whole, well. The major policy failures of the Federal Reserve—and there have been some, notably in the 1930's—have not been attributable to the organizational structure of the System. And, although there has been clear evidence of some conflict and inefficiency arising out of the present complex Federal Reserve structure, I doubt that the gains from a major reorganization at this time would be enough to compensate for the bitter political strife, the great controversy in financial and business circles, and the disruption within the Federal Reserve System that it would undoubtedly occasion. Nor do I see any need to bring the Fed under closer day-to-day operating surveillance of Congress.

My position on the five bills presently before this committee is, therefore, that, although some of the provisions have considerable merit, I do not recommend this committee's reporting them out to the House for favorable action at this time.

One organizational change does, however, seem to me to call for action now. The chairmanship of the Federal Reserve Board should be made roughly coterminous, with perhaps a 6 months lag; with the term of the President of the United States. It is no accident that both William McChesney Martin and Marriner Eccles, the two men who have guided the Federal Reserve over most of the past quarter century, favor this proposal.

To insist that a new President accept a Federal Reserve Chairman to whom he objects strongly would serve little purpose. Control over the Nation's money supply is a vital economic responsibility, given to the Government by the Constitution. Monetary policy is inextricably intermingled with fiscal policy and debt policy. The President must ultimately be responsible for recommendation and execution of the Nation's basic economic policy, under the general programs established by the Congress.

As a practical matter, the Chairman must represent the System in its most important contacts with the President, with the Treasury, and in most cases with Congress. This recognition leads inescapably to the conclusion that the Federal Reserve, and especially its Chairman, must work closely with other agencies under the general responsibility of the President for executing national economic policy.

No one seriously believes that the Federal Reserve should be expected, or permitted, to negate the basic economic goals of the Congress and the executive branch. The real question, thus, is the terms on which the Federal Reserve participates in governmental policymaking and execution. Extreme independence is more likely to mean splendid isolation than effective power in the decisions that matter. The times when the Federal Reserve has been least effective have been the times when it has been most isolated from the President and from effective working relationships with the Secretary to the Treasury and other high level governmental officials—for example, during the 1940's. The stronger role exerted by the Federal Reserve over the last decade reflects in significant part closer and easier working relationships with the executive branch of the Government. Making the chairmanship coterminous with the President's term, though it might have little importance in most instances, makes practical administrative sense.

With the present seven man board, in which only two members come up for reappointment in any one presidential term, there is little danger that this move would jeopardize the independence of the Fed in any significant sense.

With the permission of the committee I should like to submit for the record a fuller statement, "Federal Reserve Organization and Policymaking," which comments in more detail on several of the specific proposals included in the bills before the committee.

The CHAIRMAN. You may do so at the end of your statement.

Dr. BACH. Federal Reserve procedures: As I read the monetary history of the last half century, the failings of the Fed are attributable more to our lack of thorough understanding of the role of money in the economic process than to Federal Reserve organizational arrangements.

It is hard for any outsider to judge accurately without full knowledge of any hidden considerations just why Federal Reserve policies have been what they have been at many times. The Fed has a hard job, and in many respects has done it very well, I believe. Nevertheless, history suggests three important changes in Federal Reserve procedures, which may have more promise for improving monetary policy than would formal changes in Federal Reserve structure.

1. The Federal Reserve has not made it clear that it has a clear, explicit framework, or rationale, for its monetary policy, specifying the mechanism or steps connecting particular Federal Reserve policy changes with the desired end results. Federal Reserve officials have properly accepted the broad economic goals specified by the Employment Act of 1946, including reasonable price stability and the maintenance of a viable balance-of-payments position for the United States. Federal Reserve policy statements indicate recognition of a multiplicity of possible channels of impact for their policy actions (open market operations and rediscount and reserve requirement changes) on the economy. But without firm knowledge of the links connecting Federal Reserve actions with their immediate targets (for example, free reserves or interest rates) and in turn with later goals (for example, the money stock or availability of credit) and with ultimate objectives (employment, output and prices), neither Federal Reserve officials nor the public can be at all sure of the appropriateness of particular policy measures.

Federal Reserve officials speak of influencing "free" reserves, total reserves, the supply of money, the supply of credit, interest rates, the "tone" of the market for Government securities, and other intermediate variables. At times, at least, these steps appear to be inconsistent.

For example, the supply of money and the supply of credit often change at quite different rates, so it is critical for the Federal Reserve to be clear and to make clear which it is trying to influence and why. The System's heavy focus on "free reserves" as an apparent central intermediate goal of policy actions is another example.

While the Fed can substantially control free reserves, merely making free reserves larger or smaller may have little relation to whether money will be easier or tighter. For example, in mid-1963, the Fed announced a policy of "less active ease" and apparently reduced its target level of free reserves. Yet at about the same time, higher interest rates and the rising demand for funds apparently led banks to reduce even further their desired level of free reserves. Thus the Fed's policy of "less active ease" appears to have been associated with a more rapid increase in bank reserves, and hence a more rapid increase in both bank credit and the stock in money, than was true in the preceding period of presumably "more active" ease.

Surely improving our understanding of the behavior of money, and of the linkage between central bank action and ultimate policy goals, should be a major responsibility of the central bank. The Fed has an excellent research department for keeping it informed on current economic developments and for providing staff work on current issues. But unfortunately, nearly all of its expertise has been devoted to these activities, and in my judgment the recent rapid growth in tested knowledge on the behavior of money in our economy has come primarily from academic economists.

I believe that the Fed deserves criticism for its failure to push more actively on the fundamental research that must be done to continue to improve further our monetary policy. If the Fed is to make better policy, the *sine qua non* is a better base of tested knowledge on which to base that policy.

2. Federal Reserve officials appear to have generally been overly concerned with short run, "feel-of-the-market," considerations, relative to longer run goals. The operating practices of the Open Market Committee, which largely determines policy 3 weeks at a time, plus the great concern felt for the day-to-day, and even hour-to-hour, "tone" of the Government securities markets, inescapably focus a large amount of Federal Reserve attention on these issues.

The Fed's major job is to make the largest possible contribution to stable economic growth, including reasonable price stability and a viable balance-of-payments condition; not to look out for the day-to-day behavior of Government security markets. To be sure, Fed actions have their immediate impact through bank reserves and the money markets, but this does not change the major goal.

In my judgment, the Fed could properly place much more reliance on banks and other financial intermediaries to carry out their own short-run, hour-to-hour and day-to-day position adjustments, especially if it established an always open discount window with a penalty rate.

It should focus its own attention more on 3 months, 6 months, and years ahead—on countercyclical and stable growth considerations. The private financial markets are far more capable of making their own adjustments than many of us give them credit for, if they are properly warned that they are expected to do so. Perhaps the Fed always has a carefully balanced view of the short- and long-run considerations. But when any organization becomes heavily concerned with day-to-day operating details, it runs the risk that more basic but less pressing issues will be slighted. The Fed is no exception.

3. Through the Federal Reserve banks and their branches, through contacts with other central bankers, and through its own excellent research organization for gathering current economic information, Federal Reserve officials have ready access to recent developments in financial and business affairs and to the views of financial and business leaders. This is one of the strengths of the present nationwide regional setup of the Federal Reserve System.

Without impugning in any sense the motives of any of the Federal Reserve officials or of the directors and officials of the Reserve banks and branches, I suggest, however, that this may provide a somewhat unbalanced flow of information to the top officials of the System in Washington. In my judgment, the Fed has been too much isolated from much of the thinking of academic economists in the fields of monetary economics over the past two decades, and quite possibly from firsthand association with the views of those sectors of the population which are not directly involved in business, financial, or agricultural operations.

The Federal Reserve was not established to look out for banking and financial interests. Its officials do not believe that it was. Nor, I am sure, do they have the slightest intention of limiting their information-gathering network to banking and financial channels. But the inescapably close, day-to-day contacts of Federal Reserve officials with bankers and businessmen make it important for them to be doubly sure they keep open the channels of communication with other sectors of the public which have views interests at stake, and expertise on issues of monetary policy.

I believe that there is, especially within the last year or so, increasing evidence that the Federal Reserve is taking steps to improve its procedures on all three of these suggested points. It is to be commended for doing so, and one may hope that it pushes forward even more vigorously on all three fronts.

#### CURRENT MONETARY POLICY

On the issue of current monetary policy, I shall be brief. In my judgment, the results of monetary policy have turned out to be about right for 1963—in part, I suspect, because of a happy accident. The stock of money has grown at an annual rate of about 4 percent during 1963, and at an annual rate of 5 percent during the last half of the year. This compares with more like 2 percent over a period of several years before 1963, in spite of the fact that the Federal Reserve announced a movement to a policy of “less active ease” at mid-1963, raised the discount rate from 3 to 3½ percent, and apparently reduced its target level of free reserves.



This happy result permitted the economy to have a more rapidly increasing stock of money to finance the strong recovery we have seen during the past year, while at the same time higher short-term interest rates apparently helped to stem the international outflow of short-term capital.

My assessment of the economic outlook for the remainder of 1964 is a strong upward movement, resting on both the behavior of the private economy *per se*, and the special thrust of the tax reduction. To finance this recovery, which we very much need, will require more money.

My estimate is that to keep interest rates roughly stable and to finance the \$625 billion GNP estimated by the Council of Economic Advisers will require an increase of some \$5 to \$8 billion in the money stock, or an increase of 4 to 5 percent or so. This is about what occurred in 1963, but considerably more than the annual rate of the several preceding years.

In my judgment this would be about the right tentative target for monetary policy in planning for the year ahead. While I am sure we shall see some upcreep in domestic prices if the Council of Economic Advisers' estimate of the rise in GNP turns out to be right, I see little evidence of a general "overheating" of the economy that we need to squash in order to avoid a serious downturn ahead, or of a serious outbreak of inflationary price increases. Construction may be overextended. Some industrial prices are beginning to edge up. But the monetary policy implied by my suggestion above aims at just enough new reserves to finance the predicted expansion in GNP, assuming that the rate of use of money continues to increase—which it may not do.

To provide much less money would risk restricting the growth in output and employment, just as to supply much more would risk encouraging unnecessary inflation. Perhaps interest rates should be permitted to move up slightly as in past strong recoveries, but in the absence of international crises or more "overheating" than is yet evident no substantial rise in interest rates seems appropriate.

No one knows exactly what the year will bring. In assessing developments, however, it seems important to me that the Fed recognize two points. First, we need not have a downturn automatically just because employment and output grow substantially, and even though prices creep up moderately, as is implied in the Council's GNP estimates—or even if the rise is somewhat faster. Second is the probable lag in effect of Federal Reserve actions. Thus, as the year wears on and it becomes more likely that we are approaching the peak of an upswing, Federal Reserve officials will be well advised to avoid the temptation to "lean against the wind" too hard.

Perhaps clear evidence of overheating will develop, or balance-of-payments requirements may become critical. But to tighten money substantially now or toward the latter part of the year, even though the recovery seems a strong and healthy one, could easily have precisely the wrong effect—that of the upswing to a halt or of intensifying a downturn a few months later that was already in the making.

No one knows exactly how long the average lag is between tighter or looser money and the effect on employment and income, but the best estimates seem to be between 3 and 9 months. Thus, I would argue that the Fed needs always to look ahead at least that far when it takes

its policy actions, rather than merely leaning against the wind in terms of the situation at any given moment.

(The article referred to by Dr. Bach follows:)

#### FEDERAL RESERVE ORGANIZATION AND POLICYMAKING<sup>1</sup>

(By G. L. Bach, Stanford University and Carnegie Institute of Technology)

The Commission on Money and Credit, in a temperate analysis of governmental operations and Federal Reserve responsibilities, drew these conclusions concerning Federal Reserve independence:

1. The President must bear the central responsibility for governmental economic policy recommendations and execution.
2. Federal Reserve responsibilities for national economic policy are closely intertwined with those of other Government agencies, especially the Executive Office of the President and the Treasury.
3. Federal Reserve independence is now adequately protected, and Federal Reserve influence could be increased by closer participation in governmental policy determination.
4. To the end of closer and more informal working relationships between the Federal Reserve and the White House, the Federal Reserve Board Chairman and Vice Chairman should be designated by the President from among the Board's membership, with 4-year terms coterminous with the President's.
5. To improve efficiency and attract more able members, the Federal Reserve Board should be reduced from seven to five members, and all major Federal Reserve monetary powers should be centered in the Board.
6. To improve national economic policy formulation and coordination, the President should establish a cabinet-level "Advisory Board on Economic Growth and Stability," including the Chairman of the Federal Reserve Board.

These proposals have been widely criticized by conservatives on the ground that they would undermine the independence of the Federal Reserve. The critics suggest that the "liberals" on the Commission somehow outflanked the "conservatives" in bringing about this stab in the back for financial soundness (a neat trick if indeed it occurred, since two-thirds of the 20 Commission members were highly successful businessmen and bankers, only 2 were labor leaders, and the other 5 were independent professional men). On such a vital issue of monetary arrangements as this, it is well to take a closer look.

#### CASE FOR INDEPENDENCE

Stated bluntly, the traditional argument for Federal Reserve independence is that, if independent, the Fed will stand against inflation and financial irresponsibility in the Government. History tells of many treasuries which have turned to money issue to pay their bills when taxes were inadequate. The modern world's major inflations have all come with large governmental deficits, covered by the issue of new money (currency or bank deposits). While legislatures vote the expenditures, treasuries must pay the bills. Thus, it is argued that treasuries have a predictable inflationary bias, however well intentioned their secretaries may be. Against this bias, central bankers are alleged to be basically conservative; they can be counted on to look out for the stability of the monetary unit.

Another variant is based on the presumption that the entire political process is inherently inflationary. It is always easier for Congress to spend money than to raise taxes; "politicians" are inherently financially irresponsible. Thus, an independent Federal Reserve is needed to call a halt to the overspending tendencies of the politicians, and to the tendency of the politicians to plump too readily for good times for the economy as a whole, even though these good times may generate some inflation.

Lastly, there is an argument that the President, the politician par excellence, is not to be trusted on financial matters, and that an independent Federal Reserve is needed to see that he does not go too far with expansionary, inflationary economic policies.

<sup>1</sup> Reprinted with minor changes from Harvard Business Review, January-February 1962, pp. 86-91. I have analyzed these issues more fully in "Federal Reserve Policymaking" (A. A. Knopf, New York, 1950), based on a study done for the Hoover Commission on Organization of the Executive Branch of the Government, in 1948.

## MEANING OF INDEPENDENCE

These arguments suggest that we need to examine the meaning of the term "independence." Independence from whom? A Federal Reserve independent of the U.S. Treasury rests squarely on the realistic assessment of history. Treasuries have been inflationary in their biases, and we therefore need a powerful agency in governmental economic circles to stand against these inflationary biases when they threaten the soundness of our economic structure.

But Federal Reserve independence from the Congress is hardly meaningful in our governmental system. Congress established the Federal Reserve. It can change it any time it wishes, or call it to account for any of its actions. Federal Reserve officials readily acknowledge their responsibility to Congress—though the Fed need not go to Congress for appropriations to conduct its affairs and though, in practice, Congress, happily, is reluctant to intervene directly in Federal Reserve policymaking.

The really difficult question is this: Should, or can, the Federal Reserve be independent from the President? The Constitution clearly allots to the Federal Government the power to create money and regulate the value thereof. In our society, where bank deposits comprise some 80 percent of our total money supply and currency only 20 percent, control over the supply of bank deposits is control over the volume of money. Federal Reserve officials have consistently recognized the basically governmental nature of their function, though they value the close relationships they have with private bankers.

Furthermore, control over the money supply of the Nation is a vital operating responsibility. Monetary policy is inextricably intermingled with fiscal policy and debt management policy, if the Nation's economic goals are to be achieved effectively. The President must ultimately be responsible for recommendation and execution of the Nation's basic economic policy. This logic leads clearly to the conclusion that the Federal Reserve must work closely with other agencies under the general responsibility of the President for executing national economic policy.

To give an independent Federal Reserve the power to negate the basic policies arrived at by the executive and legislative branches of the Federal Government would be intolerable for any administration, Republican or Democratic. But independence, looked at practically, is a matter of degree, not of black and white. The real question, thus, is the terms on which the Federal Reserve participates in governmental policymaking and execution.

## NEED FOR COOPERATION

To be most effective, the Federal Reserve needs to be in a position to work closely with the other major Government agencies responsible for national economic policy—especially the Treasury, the Budget Bureau, and the Council of Economic Advisers. No Federal Reserve Chairman has ever claimed that the Board should disregard the debt management problems of the Treasury, or that the Government's financial needs should be given no weight.

One the contrary, all major Federal Reserve officials have agreed on the need for close working relationships with the Treasury on monetary, fiscal, and debt policy. The times when the Federal Reserve has been least effective have been the times when it has been most isolated from the President and from effective, coequal working relationships with the Secretary of the Treasury and other high-level Government officials. This was substantially the case throughout the much-discussed decade of the 1940's when the Federal Reserve was most subservient to Treasury debt-management needs. Secretaries Morgenthau and Snyder were close personal confidants of Presidents Roosevelt and Truman; but Federal Reserve officials seldom saw either President.

An effective Federal Reserve voice for the stable-money point of view can best be assured if the Fed is an active, continuous participant in the day-to-day process of governmental economic policy formation. Seldom indeed does a central bank undertake a major war with the Congress and the administration in a showdown on economic policy. Federal Reserve participation in policymaking will generally be a more effective device for presenting the sound-money point of view than will spectacular defiance of the Government's policies. Extreme independence is, unfortunately, likely to mean splendid isolation from the decisions that matter.

## ON BALANCE

The need is for recognized Federal Reserve independence from the Treasury and for coequal voice with other major agencies in the economic policy councils of the Government. In other words, the need is to maintain a strong and substantially independent voice for a stable-money point of view without placing Federal Reserve officials in an untenably isolated position, where to use their independence involves major intragovernmental conflict and divided national economic policy. Budgetary and monetary matters call for the best efforts of wise men. But we must not fall into the trap of supposing that all wisdom will reside in appointed Federal Reserve officials, rather than in other Government officials appointed by the same President and approved by the same Senate. The President, the Secretary of the Treasury, and other high governmental officials also seek to advance the national welfare, as they see it. How best to mesh the judgments and responsibilities of these various public officials is the problem, not simply to set up an independent nongovernmental board with a legal (but seldom practical) power to say no to the U.S. Government.

## RECOMMENDED CHANGES

To improve the coordination of overall economic policy and to increase the influence of the Federal Reserve while maintaining its special quasi-independent status, the Commission recommended, primarily, two modest changes:

(1) The President should establish a cabinet-level Advisory Board on Economic Growth and Stability which would include the Chairman of the Federal Reserve Board.

(2) The term of office of the Chairman (and Vice Chairman) of the Federal Reserve Board should be made coterminous with that of the President, to eliminate the possibility that a Federal Reserve Chairman would be personally unacceptable to a President.

A new President could (as now) immediately appoint one new Board member, and could name him Chairman; or he could name a new Chairman from among existing Board members. The staggered-term membership of the Board would remain unchanged, except that it would be reduced from seven to five members. While further centralization of System authority in the Board would increase somewhat the President's power over the Fed, overlapping 10-year terms would go far to protect the stability and independence of the Board members from short-run political pressures.

These two recommendations might help substantially to assure effective working relationships between the Fed, the Presidency, and the rest of the administrative branch of the Government. To insist that a new President accept a Federal Reserve Chairman to whom he objected strongly would probably serve little purpose, and would be more likely to decrease the effectiveness of the Fed than to increase it. As a practical matter, the Chairman must represent the System in its most important contacts with the President, as well as with the Treasury and in most cases with Congress. Making the chairmanship coterminous with the President's term, though it might have little importance in most instances, makes practical administrative sense. It is significant that both William M. Martin, the present Chairman of the Fed, and Marriner S. Eccles, Chairman for longer than any other man and the individual who was most responsible for the restored independence of the Fed in 1951, concur in the recommendation to make the chairmanship coterminous with the President's term.

Appointment by the President of an Advisory Board on Economic Growth and Stability would be one device for assuring closer coordination among the governmental agencies (including the Fed) responsible for national economic policy. Whether such a special advisory board would be effective would depend heavily on whether the President wanted to use it. Some such device is obviously necessary. The Commission wisely avoided a recommendation to make such an advisory board mandatory by legislation, while stressing the importance of coordinated national policy formation in which the Federal Reserve has a strong voice.

Critics have labeled these recommendations a stab in the back for Federal Reserve independence. This appears to be a serious exaggeration. They reflect operating realities, and are modest proposals indeed when viewed in the light of the experience of most other nations, where central banks have been completely subordinated to treasuries or to governments.

## ORGANIZATION AND OPERATIONS

Since the Commission apparently felt that the Federal Reserve has done a good job on monetary policy, we might expect few recommendations for change in Federal Reserve organization and operation. The Commission believed, however, that the Federal Reserve could do its job more effectively if its organization were modernized and if its controls were extended to all insured banks. It did not suggest that structural changes are of overriding importance, but that they would be useful and in keeping with modern needs and mores.

In essence, beyond the recommendations concerning the chairmanship of the Board, the Commission recommended that:

(1) The Federal Reserve Board should, as noted, be reduced in size from seven to five members, with staggered 10-year terms.

(2) Special occupational and geographical qualifications for Board members should be eliminated, and replaced by statutory stipulation that members be positively qualified by experience or education, competence, independence, and objectivity.

(3) All major policy powers (over open market operations, Reserve requirements, and discount rates) should be vested in the Federal Reserve Board. The separate Federal Open Market Committee would be abolished, but the Board would be required to consult regularly with the 12 Reserve bank Presidents in determining its policies. Discount rate changes would no longer be inaugurated separately at the 12 regional Reserve banks.

(4) Technical ownership of the Federal Reserve banks by member banks should be eliminated through retirement of the present capital stock; instead, membership should be evidenced by a special nonearning certificate for each member.

(5) All insured banks should be required to become members of the Federal Reserve System, or at least be made subject to Federal Reserve established reserve requirements.

The basic purpose of these recommendations is to centralize the policymaking functions of the Federal Reserve System in one governmental body (the Federal Reserve Board), unmistakably responsible to the public rather than to the commercial banks; to increase the efficiency of Federal Reserve operations by streamlining the present complex organizational structure; and to extend the direct impact of monetary controls to substantially all commercial banks in the country.

The present complex Federal Reserve organization reflects the regional needs of a half century ago, modified here and expanded there as the focus shifted to national monetary policy and as new instruments developed. It looks terrible on paper. But, most observers agree, it works well on the whole. Given these facts, was the Commission right that some changes ought to be made? To answer this question thoroughly would take a small book. Only a few major issues can be noted here.

## FOCUS OF RESPONSIBILITY

Few businessmen would tolerate in their own firms the complex organization and overlapping responsibilities for major policy that exist in the Fed. Open market operations, reserve requirements, and discount rates—all have identical general policy goals and need to be completely coordinated. To have a different group responsible for each invites delay and confusion. The day when discount rates needed to be set separately to meet differing regional needs is long past. Monetary policy is national policy, and is recognized as such by all concerned. Information on regional developments is indeed valuable in forming monetary policy, but this could be arranged readily without diluting and diffusing responsibility for monetary policy. So runs the argument for modernization.

But there are counterarguments. The main one is that, while this may well be true in principle, the present arrangement works well. Why change it? In fact, all 19 major Federal Reserve officials (7 Board members plus the 12 Reserve bank Presidents) consult together on all major policy issues, and, in effect, make policy together. Policy responsibility is thus not scattered. Instead, Federal Reserve policy is made in the best tradition of wide representation and careful consideration by a large group of responsible men. While monetary policy should not, of course, be regional in nature, the present system of regional banks draws presidents and board members of high ability into the System, where they could not be pulled without the attraction of policy responsibility. In policy deliberations, it is thus argued. Reserve bank Presidents both reflect regional

interests and bring monetary judgments and insights which add significantly to those found in the Washington Board.

Conclusions? Much depends on this last argument. Over much of Reserve bank history, there is little evidence that Reserve bank Presidents (with the exception of the New York President) have added much to policymaking. The last decade has seen the appointment of a number of Reserve bank Presidents of especially high ability, men whose competence in monetary economics and in practical banking compares favorably with the best of the Washington Board. It is argued that such men could not be drawn to membership on the Washington Board, with the lower salaries there. The facts are not clear, either on this or on the contribution now made by the Reserve bank Presidents to policy formation. A priori, the case for a simpler organization is strong. And most argue that the national Board is more attractive to top-quality men. The Commission has a strong point, but not all the evidence is in to permit an unequivocal conclusion.

#### A SMALLER BOARD

Suppose we agree that policymaking responsibility should be centered in one group, be it the Federal Reserve Board or the Federal Open Market Committee. How big should this group be? The Commission believes that it should be smaller than the present 12-man Open Market Committee, and much smaller than the de facto 19-man group which now makes Federal Reserve policy. The Commission plumps for a five-man board because it feels this would be more efficient, less cumbersome, and less given to delay and indecision.

Few businessmen or students of organization believe that a 19-man, or even a 12-man, committee is small enough to do an effective job of running an organization and making day-to-day decisions on intricate major policy issues. A large decisionmaking group is needed when many separate interests must be represented. But sound monetary policy formation does not rest on a compromise of conflicting regional or occupational group interests represented on the Board. Excellent regional information is needed, but the information providers do not have to be policymakers. Except for regional differences, it is not clear that the 12 Reserve bank presidents represent very different interests.

Or a large group is justified if additional members add significantly to the decision process. Both widespread experience and a priori reasoning cast doubt on the marginal gain from additional members after a committee totals a half dozen or so, unless the additional man is of especially high ability or holds quite different views from the others. In the Federal Reserve case, there seems little reason to suppose that going beyond the half dozen or so ablest men in the System is justified on either count.

We Americans traditionally distrust concentration of power in government; we value the combined judgment of a number of men. But the case for 19 decision-makers is hard to defend. The Commission's figure of five appears reasonable, and the smaller the group the better will be the chance of getting first-class men to serve on it. If a mixture of Reserve bank presidents and Washington officials is desired, a small decisionmaking group could still be obtained by combining, say, three Board members with two Reserve bank presidents on a rotating basis.

History suggests that, as a practical matter, System leadership has usually been highly concentrated in a few hands, notably Marriner S. Eccles' for many years and before that in those of Benjamin Strong (longtime President of the New York Fed). Realistically, the Chairman must represent the System in its most important contacts with the President, the Treasury, and Congress. The Federal Reserve is, in fact, a policymaking and operating agency, and it inescapably will have one or a very few men who carry most of the burden. The old judicial parallel, with the Reserve Board termed the "supreme court of finance," is not a realistic analogy. Courts apply common and statute law under an elaborate set of judicial precedents and safeguards.

As was noted above, the Fed sails on seas virtually uncharted by Congress and with heavy day-to-day operating responsibilities for our monetary mechanism. Hence, the Board is more like the Secretary of the Treasury than like the Supreme Court in its basic role (though it does have some commission-type regulatory duties). This fact further weakens the case for a large policymaking board. Chairman Martin plays the role of cooperative leader superbly, but even today there is some question whether System policy would be much different if he were a single governor, or if policymaking power were centered in a small board as the Commission recommends.

## RESERVE BANK OWNERSHIP

Technical ownership of the Federal Reserve banks by the commercial banks flies in the face of the basic constitutional provision that the Federal Government shall "coin money [and] regulate the value thereof." Surely the Federal Reserve authorities in regulating our money must be responsible, not to the bankers, but to the people of the United States, just as are the Secretary of the Treasury and other governmental officials. Perceptive bankers are the first to agree.

It is clear that both Board members in Washington and the Presidents of the Reserve banks, in fact, view themselves as public officials, sworn to advance the welfare of the people, rather than as representatives of the bankers. Why, then, bother to change the situation, even though the present arrangement is admittedly a vestige of the thinking of a half century ago? The main answer is that our national monetary authorities must, like Caesar's wife, be above suspicion and reproach. Even though commercial bank ownership of Reserve bank stock clearly does not now mean control by the bank over national monetary policy, it opens a suspicion that such improper influence might be exerted.

## BALANCING THE ARGUMENTS

The logical case for the Commission's recommendations on Federal Reserve structure is a good one. But as a practical matter, history throws doubt on their importance. Moreover, the cost of these changes would be great—in bitter argument and in deep wounds within the System. It seems unlikely today that the gains would be worth the price. My guess is that before another decade goes by, Congress will want to take a hard look at Federal Reserve organization, possibly under the pressure of new financial needs generated by changing international or national conditions. If so, the Commission's recommendations will deserve a careful look, as part of a more thorough study of both alternative organizational arrangements and the lessons of monetary history.<sup>2</sup>

The CHAIRMAN. Thank you, sir. Dr. Lerner, you may proceed, sir.

**STATEMENT OF DR. ABBA P. LERNER, PROFESSOR OF ECONOMICS,  
MICHIGAN STATE UNIVERSITY**

Dr. LERNER. Thank you. My comments will consist in part of some reference to the proposed business and in part to some general remarks on policy and philosophy of the central bank.

H.R. 3783, which would turn the Federal Reserve banks from businesses into federally regulated "cooperatives" of commercial banks, is a welcome step in the direction of formal recognition that the business of the Federal Reserve System is not the business of banking but the management of the money supply of the country as a means of regulating the total volume of spending in the economy—private consumption spending plus private investment spending plus Government spending—so as to maintain economic prosperity, price stability, and economic growth or the best obtainable combination of these objectives.

The historical accident that the management of the national money supply developed out of the banking business is responsible for monetary policy being distracted from its proper objectives by the bankers' natural but strictly irrelevant concern with such matters as the quality of bank credit. The development of the banking business in turn from the goldsmith's trade is perhaps similarly responsible for concern being diverted from total spending to gold reserves and gold

<sup>2</sup> As a practical matter, the present chaotic conflict among Federal bank supervisory agencies (the Fed. Comptroller of the Currency, and FDIC) poses the most urgent problem of reorganization or at least better working coordination of Federal policies. I have presented an analysis of this issue in Bach, "Federal Reserve Policymaking," ch. 15.

values. H.R. 3783 would not in itself make any important change in the immediate future since the officers of the Federal Reserve System regard themselves at present as guardians of the general interest, but the transformation of the System from a number of banks owned by other banks into an explicit instrument of the Government—a monetary authority charged with the management of the money supply—would tend gradually to eliminate the vestiges of bank manager mentality, which, however, appropriate for bank management, has been hampering the efficacy of national monetary management.

With this end to the fiction of the Reserve banks being merely businesses in which commercial banks choose to invest, membership in the monetary authority should be made compulsory for all commercial banks.

H.R. 9631 is directed at making the Federal Reserve Board more responsive to the general policy of the administration. I strongly favor this since I consider it repugnant to the principles of democratic government for the Federal Reserve System to constitute a fourth power, independent of the legislature, the executive, and the judiciary, especially if it is not subject to popular election.

The controllers of the money supply must be subject to the overall policy of the Executive. Day-to-day activities must be in the hands of experts who should be able to make public any important disagreements with the Executive, but in the case of ultimate disagreement the monetary authority must give way—not the President.

The independence of the “central bank”—as is indicated by this traditional name for the monetary authority—is only another vestige, that has to be shed, of the origin of monetary management in banking history. I therefore favor the shortening of the term of office of Governors, though I would think that in view of the specialization that is required a term of 6 or 8 years might be better than 4.

I would prefer the number of Governors not to be increased as this would tend to lengthen deliberation about policy actions, and more speedy action is usually desirable, even if it should sometimes turn out to be the wrong action. The actions can be reversed. Their work could be lightened by transferring the regulatory tasks to other authorities like the FDIC, or the Comptroller of the Currency. Such a further separation of banking chores from the monetary authority is desirable in any case.

I do not think it good for the Secretary of the Treasury to be on the Board. Even if he is not the chairman he would carry too much weight, and he tends to have his own special concerns, such as minimizing the service charges on the national debt, which can be even more damaging to appropriate monetary policy than the preoccupations of bankers. Bankers as such should not be given any special representation on the Board.

I concur with the suggestion that the Board take over open market policy.

On the questions of the advisory committee and the auditing procedure I have no opinion to give.

H.R. 9685 provides for the Federal Reserve banks to hand over almost all their income—interest on U.S. bonds—to the Treasury and to subsist on appropriation from Congress. This is inadvisable as it



would create a double dependence: On the Executive for selection of officers and general policy directives and on Congress for housekeeping money. All ultimate control should be in the Executive.

I have some sympathy with the intent of providing some budgetary discipline on the Reserve banks in addition to their pride in the size of the check for profits transferred to the Treasury, but the proposed cure is certainly worse than the malady.

H.R. 9686 provides for the commercial banks to pay interest on Government deposits and to be paid by the Treasury for services performed. This makes good sense and I support it.

H.R. 9687 eliminates the prohibition of interest payments on demand deposits. This prohibition seems to have been based on a fear that competition was dangerous for banks and has only led to round-about and wasteful forms of competition. It never made any sense and its elimination is eminently desirable.

#### SOME GENERAL REMARKS

Independence of the monetary authority from the Executive in matters of policy, even if both do the best they can in the public interest, leads to fiscal and monetary policies working at cross-purposes, defeating each other's objectives.

It enables both the Executive and the monetary authority to blame each other for whatever happens to the economy. It also prevents coordination where this is necessary for the sake of carrying out inevitable compromises between different objectives of monetary and fiscal policy. High employment, price stability, economic growth, and balance-of-payments issues are only the most important of these objectives. The same policies do not always serve all of these objectives. Tradeoffs between them necessitate cooperation and coordination of monetary and fiscal policies.

Some have sought to avoid both the independence of the monetary authority and its subservience to the Executive by abolishing the monetary authority altogether, replacing it by an automated mechanical rule for an unvarying weekly or daily proportional increase in the money supply.

While Milton Friedman has shown that such a device would have done better in the past than was in fact done by the Federal Reserve System, he has also uncovered many of the causes of the mistakes made and it is clear that the most important of these causes have been removed by devices such as Federal deposit insurance.

Therefore, I have confidence that humans could do better than such a rule in the future. In any case they could not be depended on to keep to the rule.

As to the level of interest rates and the money supply, it is my feeling that lower interest rates and a greater money supply would have done much more good than harm, and possibly no harm at all. The higher income level would have increased demand for imports and the lower interest rate would have induced more idle money to be held abroad, but the higher level of employment would have made investment in the United States more attractive compared with investment abroad and thus might very well have offset or more than offset the first two influences on the balance of payments.

This cannot be known with any certainty, but in any case the loss in national income from higher interest and lower money supply is almost certainly much greater than any real cost that would have been involved in a larger gold drain.

But it is unfair to blame the Federal Reserve for restrictive measures that it felt itself bound to undertake in order to improve our balance of payments. I think it is unfortunate that this consideration should be added to the other distractions that make it harder for the monetary authority to concentrate on the internal objective of high employment, price stability, and economic growth.

Ideally the balance of payments should be nobody's concern but allowed to correct itself automatically via the free price mechanism in a regime of free exchanges. But if it is the policy of the Government to maintain a fixed rate of exchange, this task should be shared between the different measures that could contribute to it—wage policy, antitrust policy, tariff and trade agreement policy, foreign aid and foreign military expenditure policy, et cetera.

All these should be coordinated with monetary policy. Yet it seems that the bulk of the burden is thrust on the monetary authority for no better reason than that the bankers, in their invaluable historical contribution of developing a monetary authority from scratch, considered the maintenance of the gold value of the dollar (or the pound sterling) to be their very first responsibility—sometimes even the only one. With our completion of the recognition that the proper task of the monetary authority, within the overall responsibility of the Executive for the state of the Nation, is to manage the money supply, the task of maintaining a given rate of exchange (until we give this up) should in the main be someone else's job, leaving the monetary authority free to concentrate primarily on supplying the appropriate quantity of money while cooperating with the other Government departments, and in particular with the fiscal policy agencies, in the maintenance of domestic prosperity, price stability, and economic growth.

The CHAIRMAN. Thank you, sir. The statements of you gentlemen are appreciated. I agree with much of what you said and where I do not agree I think your statements are real fine and interesting and will be given careful consideration by this committee.

Dr. BACH, you are familiar with Dr. Friedman's views, are you not?

Dr. BACH. Reasonably so, I think so.

The CHAIRMAN. Do you agree with him in whole or in part or how do you value his judgment—how do you evaluate his views?

Dr. BACH. You refer primarily to his rule for a monetary policy?

The CHAIRMAN. Yes, sir. He does not look with favor on this minute-to-minute and day-to-day operations of the Open Market Committee.

Dr. BACH. I value his research very highly. I think he has thrown a great deal of light on the working of the monetary mechanism. I do not think that the conclusion follows, necessarily, from his research, that we should have a rule to replace the Federal Reserve. But my judgment is that he has shown us that money plays a very important role in the determination of the level of the economic activity. He has shown us some of the links between money and the changes in the level of economic activity.

But, the jump from that to the conclusion that rule should take over from men in the present state of knowledge, I don't think is a justified jump at this point. So I do not agree with his proposal that we have an absolute rule that increases the money stock at 3 or 4 percent a year.

I would like to add one word to that, however. I think the Fed would do well to have very much in mind the fact that on the average over the long pull there will have to be an increase in the money stock at something like the rate of growth of output of the economy at stable prices. And if I were a member of the Federal Reserve Board, I would want to have this as one of the very important charts on the wall, so to speak, to remind me at all points in time that I ought to be getting a roughly stable growth in the money stock unless there is some clear reason to the contrary.

The CHAIRMAN. Do you think that the Fed has been too restrictive in the past?

Dr. BACH. I would want to answer that in part. Sometimes I think it has.

The CHAIRMAN. What about 1957 and 1958 and say 1960?

Dr. BACH. The Fed's action on the investment boom in 1957 was, I think, a debatable one in the strength of the action it took. I think reasonable men can differ on this. My own taste is that it was somewhat too restrictive at that point and my own taste has been that it has been on the whole slightly too restrictive over the past 5 or 6 years.

The CHAIRMAN. Dr. Lerner, you mentioned something about low interest and high interest and you did not see anything very bad in high interest; in other words, that lower interest would have possibly caused some trouble. That was the tenor, if I understand it?

Dr. LERNER. No. I think that my opinion has been expressed almost exactly by what Professor Bach has just said. A policy of lower interest rates and increased money supply, while it does lead to more economic activity does create some problems for the balance of payments. But my view is that the domestic matters are so much more important that we should have had easier money and lower rates of interest in spite of these effects.

The CHAIRMAN. It should be mentioned that if the interest rates that prevailed after the war had continued and had not increased, we would have a national debt that would be \$40 billion less than it is today. It has been determined that every deficit we have had since then was caused by higher interest rates.

Did you look with favor upon those higher interest rates, Dr. Bach?

Dr. BACH. It seems to me that there is a good case for higher interest rates when one wishes to restrain the level of economic activity.

The CHAIRMAN. Right there, might I suggest, that can you not use other weapons just as effectively, particularly increasing reserve requirements of banks and get the same results or better?

Dr. BACH. I think you can use other weapons and you can use fiscal policy as another weapon. But to speak specifically about the possibility of raising reserve requirements instead of using Open Market Operations, I would say that these are alternative devices. In principle, either can be used equally well. This gets one into two questions. No. 1, the Federal officials are firmly convinced, I believe, that

the Open Market Operations give them more and more of a flexible tool. Second, there is the issue of bank earnings. The banks do obtain important earnings from the holdings of Government securities.

As you point out, this is a price paid by the Government when it issues securities. On the other hand, since the banks do render substantial services, this is a device, as many people have pointed out, for reimbursing the banks for services rendered. I am not sure it is the best device for doing it.

It seems to me that by and large, however, we should use that monetary instrument which has the best chance of helping us on economic stability. I do not quite understand the calculation of the \$40 billion, so I cannot comment specifically on that. But I would not feel alarmed at the fact that higher interest rates have been used to restrain economic activity through the period since 1953.

The CHAIRMAN. If it was the only way to do it, of course, I would have to agree that many times in the past that it was correct to increase interest rates. But I do not agree that that is the only anti-inflation weapon at all.

You mentioned something that Mr. Eccles always brought up. He was the former Chairman of the Federal Reserve Board. He said you have got to either let the banks expand and increase their earnings by increasing interest rates or you have to subsidize the banks, and he said it is better to let them make these extra earnings by raising interest rates and not subsidize the banks.

I know this is an argument that also has been made by other persons, other than Mr. Eccles. But he always came out for this forthrightly with that statement when he was asked about this particular subject.

I also think the banks are entitled to good earnings and I want to see a profitable banking system. We cannot have a good banking system unless it is profitable. But I do not see why we should do many of the things we do for them.

For instance, the national debt today I guess is around \$180 billion or \$200 billion, marketable debt. It is approximately that. About a third of that national debt, marketable debt, is held by the commercial banks. I do not object to the commercial banks owning a reasonable amount of Government bonds, just as secondary reserves or other purposes. But we have let them create money on their books, money based on the credit of the Nation, to buy Government bonds, and they get interest from the Government. I think is going rather far. Of course, this is really a direct subsidy because we do not need the banks to buy these bonds.

The Federal Reserve can buy any bond that the commercial banks do not buy. There is no reason to pay banks to create money spent by the Government. If budget deficits *require* creating money, the Government doesn't have to pay banks interest to create it. Also, I view it as a departure from a sound money system for banks to acquire long-term Government bonds that way with created money. That is getting them away from the whole community where bank money is needed for many different purposes.

It entices the bankers to forget the local people and local interests when they can go into something where there is no risk. And I think that is getting them away from the principles of a sound money system. I think it is going too far. So I think whenever banks are

permitted to increase their long-term Government securities and to invest in long-term Government securities with created, manufactured money, it is going too far. And now they want us to permit them to go into the business of manufacturing money on the credit of a nation, long-term money, to buy tax-exempt bonds. That is bordering on immorality in my book. That is just going too far.

Of course, my views are not accepted by everybody. Obviously, they are not. But it is hurting the Government and business in a way. You take 3½ percent tax-exempt bonds—they have the earnings of about 7.2 percent securities that are taxable. And so it is just going against the Government and business the way I see it, if we let them increase their purchases of tax-exempts. I have probably taken more time than I should. Mr. Widnall?

Mr. WIDNALL. Thank you, Mr. Chairman.

The chairman has just made a rather broad statement saying it has been determined that every deficit was caused by higher interest rates.

The CHAIRMAN. Since 1952.

Mr. WIDNALL. Since 1952, would you both agree with that statement? Dr. Lerner?

Dr. LERNER. I think it is impossible to say which part of a deficit is caused by what since the deficit is the sum total of all the activities together. You can of course arbitrarily pick any number on one side of the accounts and say this is the one responsible for a particular number on the other side, but that association is of no real significance.

It is true that if everything else had been the same and less interest had been paid on the existing outstanding debt, then so much less money could have been borrowed by the Government and I understand that this is what the chairman had in mind.

I would agree with part of what he says, but maybe not the parts which he emphasized. I would agree that during most of the period a lower rate of interest would have been desirable, but I think so, because of the effect on the economy in increasing the level of economic activity and giving us more employment and prosperity.

As to the effect of the debt, that is, making the national debt larger, I do not think this is of great importance.

Mr. WIDNALL. Would you care to comment on that, Dr. Bach?

Dr. BACH. Dr. Lerner has said substantially what I think is correct. It is extremely important, as in standard bookkeeping, to avoid concluding that any particular item on the one side of the books accounts for a particular item on the other. Whereas I am sure the chairman is correct if he has done the calculation about the \$40 billion of national debt, I would not want to attribute that, as Dr. Lerner just pointed out, specifically to the higher interest rate policies followed. In my judgment as in Dr. Lerner's, the important thing is what impact policies have on overall growth and stability rather than what happens to the national debt.

Mr. WIDNALL. Dr. Lerner, do you believe this: that there should be a ceiling on interest rates?

Dr. LERNER. No, I think the hands of the authorities should be free to raise the rate of interest if there is good reason. There may be good reason for raising the rate of interest, if, say, we are threatened by too much private investment which would cause inflation.

I do not think this is the case at the present time. But I would not like to have a ceiling which might be in the way at some time when it is desirable to raise rates of interest.

Mr. WIDNALL. The point that I am really making is: Is it desirable to have as low an interest rate as possible because it stimulates the economy and stimulates employment?

Dr. LERNER. Up to the point where you may overstimulate the economy and get inflation. I don't think this is the danger at the moment.

Mr. WIDNALL. Dr. Bach, would you care to comment on that?

Dr. BACH. Again, I agree with what Dr. Lerner said. I thought you were referring to another question as well, that is the interest ceiling on the rate which may be paid by the Federal Government.

Mr. WIDNALL. I should have particularized it more. I had in mind both approaches to it. Will you comment on that?

Dr. BACH. I do not believe we should have a ceiling of the sort that now exists on the rate that may be paid by the Federal Government. It seems to me that this is an artificial device. It is not a good device for regulating Government expenditures, and I see no reason for having it, therefore.

Basically, it seems to me that our Nation needs to use interest rates as a device for stabilizing the economy and for helping to grow at a pace that is consistent with our national goals. We can easily overstimulate the economy. It has been overstimulated from time to time in the past. However, that is where I would put my emphasis. Interest rates are one tool of national economic policy, that we can influence through monetary policy, and we ought to use that tool to achieve our major economic goals which I take to be high employment, relatively stable prices, and the reasonably rapid rate of economic growth.

Mr. WIDNALL. It has seemed to me in the testimony of a number of economists that have appeared before us that they have failed to take into account to a major extent the world impact on our economy. They have been talking about what would be a perfect way of handling our own economy without figuring into their calculations the effect of changes in interest rate, discount rates, and flow of money with respect to the other central banks of the world. It is extremely important, is it not, that this be measured also by the Fed when they are making changes in their own actions?

Dr. BACH. Yes; I think it is important. However, I would like to distinguish between what the Fed must do under the present institutional arrangements and what might be done to change the institutional arrangements for the whole balance of payments.

Given the present institutional arrangements, I would completely agree with your statement, sir, that the Fed must take into account the interest rates abroad because of the problem of capital flows in our balance of payments.

My understanding is that they do take that into account very actively.

My own assessment is that they have been somewhat overly concerned with that in the last 2 or 3 years. I have the feeling that we could afford to take a bit more risk, if you want to put it that way, with our gold stock, and my own recommendation is very strongly,

that Congress should eliminate the 25-percent gold cover requirement. I think we have imposed an arbitrary restriction on ourselves there, and if this change were made, then the gold problem would seem much less pressing, much less of a crisis to us as our gold stocks go down closer to that \$12 billion figure where we use up all the free gold. So this is what I meant when I said I think given the present institutional arrangements, the Fed should pay a lot of attention to interest rates abroad, but perhaps not quite as much as it has.

I would like to see us consider changes in institutional arrangements which would free our hands much more, and Dr. Lerner has referred to the other one which would be freely fluctuating exchange rates which would free our hands for focusing on domestic economic issues.

I personally doubt that this is seriously likely in the foreseeable future, and I am not sure I would favor going this far into the immediate foreseeable future. But I think we can afford to be a bit more flexible about it than we have been thus far.

MR. WIDNALL. Dr. Lerner, you would agree the Fed is not responsible for fiscal policy?

DR. LERNER. That is correct. I agree.

MR. WIDNALL. So that it is wise with respect to fiscal policy and monetary policy, to correlate their efforts so that we keep in mind what is taking place. But to manage fiscal policy you cannot fit it in completely with monetary policy.

DR. LERNER. Of course, fiscal policy is not the responsibility of the Federal Reserve. They can't decide what taxes the Government should impose or what expenditures the Government should make.

MR. WIDNALL. If the proposals in one of the bills pending before the committee were followed and the Secretary of the Treasury became Chairman of the entire operation, would you not then mix the fiscal policy and monetary policy?

DR. LERNER. Well, this would enable more coordination, that is, you would not have fiscal policy directed at lowering the level of economic activity while monetary policy was trying to increase it, and I think it is desirable that such working at cross-purposes should be avoided. The ultimate policy of the Government must be one which takes into account both fiscal policy and monetary policy. Ultimately it has to be the President who considers both of them and sees that they are not fighting each other.

On the other hand, although I believe that having the Secretary of the Treasury on the Board would facilitate coordination, I do not think it is a good idea because he is likely, and in the past has tended, to make the policies of the Federal Reserve subservient not to fiscal policy but to other responsibilities of his such as economies in the management of the interest payments on the national debt. That seems to me to be something which is undesirable because it would distract the Federal Reserve from thinking about its much more important objective of supplying the right amount of money for the economy.

MR. WIDNALL. Thank you, Dr. Lerner. Dr. Bach, would you comment on that proposal, too?

Dr. BACH. I am opposed to the proposal that the Secretary of the Treasury be formally on the Board either as Chairman or as a member of the Board. I am opposed because I believe the existence of anything like the present Federal Reserve System presupposes the need for a different point of view than would be represented by the Treasury and is directly represented by the administration.

Many people have pointed out that this notion of independence is a tenuous one. It is not a black-and-white issue. It is an issue of trying to develop an arrangement whereby the point of view traditionally expressed by central banks—which is a somewhat more restrictive point of view, which is a point of view more concerned about infiltration than is often true for the executive branch of the Government—is properly represented in the making and executing of overall Government policy. But at the same time, it would be very foolish indeed, I think, to have a completely and strongly independent Federal Reserve in the sense that it had the power to negate the basic policies of the Congress, of the President, and of the Secretary of the Treasury working with the President.

So as I tried to indicate in my brief statement, the issue here is how do we maintain a considerable degree of independence, but still maintain a close working relationship with the executive branch?

If one looks at history, the experience, when the Secretary of the Treasury was a member of the Federal Reserve, was very bad. The problem was not that he dominated the thing, but that he paid little attention to it. He did not show up for meetings, and it just was a bad working relationship. His main interests were other than the Federal Reserve. The Secretary of the Treasury has a very busy job on his hands as it is and to suppose that putting him on the Board is the effective way of coordinating the economic policies of the Government is not to size up as a practical matter the responsibilities that these men have.

I would like to say just one word at the close of that. I think it is extremely important to integrate monetary and fiscal policy. But as Dr. Lerner has pointed out, the Congress of the United States really makes the fiscal policy in the last showdown, you gentlemen being the ones who vote the taxes, expenditures. One of the cases for monetary policy is that it can be more flexible than is possible with the whole governmental expenditure and taxing mechanism.

Mr. WIDNALL. Mr. Chairman, yesterday one of the witnesses testified that he felt that it was advisable not only to have the Secretary of the Treasury but the Chairman of the Council of Economic Advisers and the Bureau of the Budget representatives on the Federal Reserve Board.

The CHAIRMAN. Ex officio.

Mr. WIDNALL. In view of that suggestion, do you not think it would be wise if we asked representatives of both the Council of Economic Advisers and the Bureau of the Budget to come up and testify?

The CHAIRMAN. We are considering that now. You see, they are both arms of the President.

Mr. WIDNALL. I would like to make that suggestion.



The CHAIRMAN. They are direct arms of the President. Let us give it a little more thought, Mr. Widnall. We want to do absolutely what would be in the interest of the hearings and will certainly bring out everything that is possible and it is possible that they could contribute something to our hearings. I would not like to pass on it right this minute, if you please.

Mr. WIDNALL. Thank you, Dr. Bach. Thank you, Dr. Lerner.

The CHAIRMAN. Mr. Minish?

Mr. MINISH. Dr. Bach, would you care to comment on 9631 where Dr. Lerner says in his statement:

The controllers of the money supply must be subject to the overall policy of the Executive. Day-to-day activities must be in the hands of experts who should be able to make public any important disagreements with the Executive.

Dr. BACH. I do not have a copy of Dr. Lerner's statement before me, so I will have to comment in somewhat general terms on it. I think, as I indicated a few moments ago, the issue here is not a black-and-white issue of independence. It is an issue of what is the best way for us to maintain the advantages of a separate monetary authority, which over the years the Congress has certainly wished to maintain, without making that monetary authority so separate from the other activities of the Government that it gets out of step seriously, so separate that it really attempts to abuse the independence and the power that it has.

Now, I do not know whether you call this a fourth arm of Government or not. I do not, because I do not think the Federal Reserve has acted that way and I don't think it can act that way.

If it seriously acted as a fourth arm of Government and began to throw its weight around, so to speak, then the Congress of the United States would soon tend to that. You would be unwilling to tolerate that, just as the President would be very unhappy with that.

It is very difficult, in a complex organization like the Government of the United States to set up a nice set of precise rules that separate out the powers and the responsibilities of the various parts of the organization. It does seem to me that what has been going on in the last few years has worked very well from this point of view, that Chairman Martin and the members of the Federal Reserve Board and the Open Market Committee have been in close informal consultation with the U.S. Government in the administrative branch. They have spoken to the committees of the Congress frequently, and it seems to me that they feel a great deal of pressure, if you like, a great deal of responsibility to work closely with the administrative part of the Government, notably with the Secretary of the Treasury. And I am sure that they will consult actively with the Council of Economic Advisers.

It seems to me this is the kind of an arrangement we need, not a formal requirement that puts the Chairman of the Council, the Secretary of the Treasury, or any of these other people on the Board, because I do not think that will work. It would not achieve what would be wanted. I do not think therefore that what may have been implicit in Dr. Lerner's comments, that this independence comprises a fourth arm of the Government, is a very happy figure of speech for the

way it has been working. I think it is working rather well now and I think we are getting what we want pretty much.

Dr. LERNER. Dr. Bach has done a remarkable job of explaining what I meant to say until his last sentence. I do not mean to say that at the present time the Federal Reserve is a fourth independent arm of Government parallel to the other three. I only say that statements which are frequently made of the independence of the monetary authority, if they were taken seriously would mean just that. But they are not taken seriously because obviously we do not want to have a four-sided government. We are very happy with our triangular government. And therefore I agree with Dr. Bach and all the rest that we need cooperation. We need enough separateness between the monetary authority and the fiscal authorities for there to be some sense in saying they have to be coordinated. They should be neither completely independent or completely integrated into a single unit.

Mr. MINISH. Thank you.

Dr. Bach, how do you feel about H.R. 9686 which provides for commercial banks to pay interest on Government deposits?

Dr. BACH. That is a technical point in which I do not pretend to be a real expert. May I comment more generally on the problem of commercial bank interest rates? It is not a direct answer to your question.

My own judgment is, as Professor Lerner said a few moments ago, that our particular regulations on commercial bank interest rates are unfortunate. We would be better off if there were not now regulations we have. They should be free to pay interest or not to pay interest on their deposits as seems to be wise in terms of their business affairs.

I think the particular points you raise are all mixed up with the issue of bank earnings, of course. The Chairman has correctly pointed out that reasonable men can differ about whether bank earnings are adequate or not adequate, and men can differ as to what is the most reasonable way for the Government to pay for services received from the banking community, and it does receive very substantial services.

My own taste is that the present arrangements are pretty good and work out rather well. On the other hand, I do not feel competent to speak in great detail over the particular administrative arrangements involved here.

Mr. MINISH. When you said they work out rather well, do you mean for both sides, the Government and banks or just the banks?

Dr. BACH. I think they work out well for the banks, but I do not think in the process the Government gets a bad deal, if that is what you are implying.

This is a difficult question in cost accounting as to how much it does in fact cost the banks to render the services that are rendered to the Government.

Back in the days of World War II when I had the opportunity of working for the Federal Reserve for some period, we did worry about this, of course, because the securities being bought by the banks were going up very fast, indeed. But at that time I became fairly convinced that the services being rendered by the banks were also rising

very rapidly and on the whole it was a pretty reasonable way to do the job. I would be very reluctant to say more than that because I don't think there is any very nice, precise way one can balance these things off.

Mr. MINISH. Dr. Lerner?

Dr. LERNER. I would like to say I am less of an expert on this than Dr. Bach is. My point is not that I know that the banks are being paid too much. They maybe are being paid too little, for all I know. But I think you can do a better job if you pay directly for the services. You would then know that you are paying for what you get and not hoping that the interest you don't get on Government deposits happens to be just right to cover the banking services you don't pay for.

Mr. MINISH. Thank you. That is all.

The CHAIRMAN. Mr. Brock?

Mr. BROCK. Dr. Lerner, would you endorse the statement of Dr. Bach that we should remove the 25 percent reserve?

Dr. LERNER. I completely support that proposal and I would want to go further and free ourselves altogether from the fixed exchanges. But removal of this 25 percent would mean that we would only be faced with a problem only when we ran out of gold and not by an additional problem of our own making when we find we have only \$12 billion worth.

Mr. BROCK. I am sorry. Let me rephrase it and see if I understood you properly.

You are saying with the current problems we face, removal of the restrictions would not solve the basic problem, that we could still run over the \$12 billion?

Dr. LERNER. I think I didn't put it very clearly. I would say that as long as we keep to the system of fixed exchanges with gold for international payments, then the only reason for our having any gold is that we might need it to make these international payments. Then to say that we are not going to use the gold for making these international payments, but keep \$12 billion locked up seems to me silly. This is what it is for—to pay in case we have to.

Therefore, I would support completely and without any hesitation the removal of such a particular tying of our hands for no good reason that I can see.

Mr. BROCK. You would remove all restrictions and have completely free exchange rates between currencies?

Dr. LERNER. That is true. I am in favor of free exchange rates even though I agree with Dr. Bach that it is unlikely that this good idea will be adopted in the near future. But even if we have fixed exchanges, we should be ready to use the gold for the purpose for which we have it.

Dr. BACH. May I say one more word on that, sir?

It seems to me each time this proposal to remove the 25 percent restriction comes up, the following reason is advanced for not doing it—well, it is a pretty good idea, the argument is, but we dare not do it now because it will upset things if we do it. Now, the only time you do it is when everything is calm and peaceful so we don't upset

people by doing it. But when it is calm and peaceful nobody worries about doing it. So the result is that it seems to be a good idea to almost everybody, but there is always the reason that this is not the right time to do it.

It does seem to me that this reasoning can lead us into unfortunate circumstances and I would argue that now is the time to do it. We are not in such a precarious position on our international balance of payments that this would upset people greatly. The balance of payments is substantially better now from all the evidence we have.

Mr. BROCK. But you would not go so far as to say, would you, Dr. Bach, that we should remove the gold standard, that we should completely eliminate gold as a fixed value?

Dr. BACH. I think that I would not go that far if I understand what you are saying.

Mr. BROCK. Dr. Lerner said we ought to have a completely free exchange. Would you say that?

Dr. BACH. I would say, if I were standing in my classroom at this moment and explaining to the students what would be an ideal situation if we were starting from scratch, that this would be a better situation to have. I would not say if I were speaking as an expert in answer to your question that we should move to a system tomorrow, no.

Mr. BROCK. On this question of interest rates, during World War II and for about 6 years thereafter we had a maximum interest rate or maximum yield allowed on Government securities of say 2½ percent or thereabouts. During that time, of course, during World War II we had wage controls and prices remained relatively stable, but a fairly large pressure was built up under this lid.

After the war we released the price and wage controls and maintained the ceiling on interest. As a net result we had a 70-percent increase in prices from 1946 to 1951. Would you give me an assessment of what would happen if we kept that ceiling on interest from 1951 on until this time?

Dr. BACH. Are you addressing me or Dr. Lerner?

Mr. BROCK. You, Dr. Bach.

Dr. BACH. If we had continued to peg the long rate at 2½ percent, which I think is the situation you are describing, through monetary policy, I cannot give you a quantitative estimate of what would have happened, but it seems to me we would have had just lots of inflation between 1951 and now. This is a matter on which one would have to go and do a good deal of arithmetic to make a reasonable kind of estimate.

What this would imply is that interest rates would for a good share of that period have been held below the level that the market would have been trying to establish for interest rates, and thus that the Fed would have continually had to push more money into the system to keep interest rates down, so we would have ended up, I suppose, with a very large money stock indeed by now with a lot of inflation.

Mr. BROCK. Would not this inflation, contrary to our professed goal of full employment, perhaps, have created unemployment because we would have been in a position of having almost no competitive ability in competition with the rest of the world with inflation pushing us up so fast in this country?

Dr. BACH. That is a difficult question you are asking as to just what the effect of an unspecified amount of inflation would have been, since I haven't been able to say just how much inflation there would be.

Mr. BROCK. In 6 years it went up 70 percent and in the next 12 it could have gone up 140 percent. This is something that is possible. But it is just to use that as an example.

Dr. BACH. May I answer that in two ways?

No. 1, I think it is clear that if we had a lot more inflation than we have had, this would have worsened to some extent our international competitive position. One reason it is hard for me to answer, is that this might have changed how much inflation other countries might have had as well. It would be difficult to know where we might stand compared with other countries under these circumstances.

The second point I would like to have made is this: So far as the domestic effects of inflation are concerned, I think these are unfortunate, but I also think that they are not as unfortunate as is often felt. A modest amount of inflation is not seriously disruptive for the domestic economy, although the amount of inflation one would have had with a 2½ percent rate over the last 10 years does not seem to me a moderate inflation. It would have been a whopper of inflation and could have been very disruptive, indeed.

Mr. BROCK. It could have violated our idea as expressed in the Full Employment Act, could it not?

Dr. BACH. Well, as the chairman knows from times in which I have appeared before the Joint Economic Committee, it is not clear to me what the Full Employment Act does say about price stability. But I take it that is not an issue you want to get into this morning.

Implicitly one sets roughly stable prices as a goal of the Employment Act, and the likely inflation would certainly violate that.

Mr. BROCK. If I may summarize, then what you are saying, we have a desirability here—a desirable goal with lower interest rates, but this has to reflect current economic conditions. It cannot be a fixed standard which applies at all times. It has to fluctuate. The monetary policy has to be flexible to take into account all the factors in the economy. You cannot operate in the sole context of our domestic economy. You cannot do this any more than you can operate strictly on the basis of whether it is inflationary or deflationary. You have to take into consideration employment and so forth. There are a number of factors involved. This is not something we can pin down with a particular formula. It is subject to some consideration among monetary authorities.

Is this a fair summation of the opposition?

Dr. BACH. I think it is. I would put it into somewhat different words, but roughly that is true.

Let me say a word on that. I do not think low interest rates per se are good. Nor do I think that high interest rates per se are good. Interest rates are a price, a very important price in our modern economic system, and by and large the market will set that price at different levels under different circumstances.

We can influence that price, and since it is a very important price it may be important for us to influence it. It is important because the way we influence the interest rate is going to have a lot to do with the level of total spending, total borrowing, investment, and consumer spending in the economy. And since I put a lot of stress on monetary policy as a device, I want monetary policy to put the interest rate up when it is good to put it up and down when it is good to put it down. I don't see high or low interest rates per se as the end goal of our policy.

Mr. BROCK. Dr. Lerner, in your statement you suggest that the Federal Reserve should be more directly influenced—I think you say all ultimate controls should be in the Executive, but then just before that you say you do not think it is good for the Secretary of the Treasury to be on the Board. I gather this is because of the obvious conflict of interest which might occur.

Dr. LERNER. That would mean day-to-day control rather than ultimate control.

Mr. BROCK. That is correct. Would you endorse Dr. Bach's suggestion that the term of the Chairman should be approximately equivalent to the term of the President. In other words, when a new President comes in he has authority to appoint a member of the Board whom he can make Chairman? Is that sufficient or should we go further?

Dr. LERNER. I think it is a good idea. Sufficient for what?

Mr. BROCK. To achieve your goal of placing all ultimate control under the Executive.

Dr. LERNER. I would do that.

Mr. BROCK. For long-range policy.

Dr. LERNER. It would do that. The Executive could change the Chairman and Board if they were not doing what they ought to do.

Mr. BROCK. You are saying we should go further and give him authority to replace members of the Board at any given time?

Dr. LERNER. I did not intend that and I would not be in favor of that. This is where we get the shadowy line of some degree of independence. Just as I would not want to have any detailed supervision, I wouldn't like them to say, "If I do this I will be fired next week."

Mr. BROCK. I appreciate that because I was confused. I thought you had endorsed the bill as it was written in that first section which would give the President complete authority to hire and fire at will each member of the Board.

Dr. LERNER. I would not be in favor of that.

Mr. BROCK. Thank you very much.

The CHAIRMAN. In speaking of interest rates, I make a difference between the rate that the Government pays and the general going interest rate in the economy.

Now, I think that Mr. Brock must be considering that if we kept down all interest rates in his illustration that certain things would have resulted. Now, our people with the Government cannot determine what all interest rates will be, but they can determine what the interest rate of Government bonds will be.

Consider those years from 1939 to 1952, 12 years, hard years for our country. We had 10 and 12 million people unemployed in the beginning of that time and during part of it we had a war, when we were spending a quarter of a billion dollars a day on the battlefield. During the war we denied people the opportunity to buy automobiles, appliances of all kinds that they needed, and this caused a pent-up demand of purchasing power, bank deposits, money on hand. After the war it was this pent-up demand that forced the inflation. It wasn't so much that we kept interest rates on Government bonds down after the war, as the money which the Government paid banks to create during the war that caused the postwar inflation. The banks didn't even need reserves to buy Government bonds during the war. They needed only a flick of the pen. They didn't have to give up any alternative because they didn't need excess reserves to buy Government securities. That requirement was waived during the war. It was the money created during the war, you see, which was the source of the huge pent-up consumer and investor demand after the war. Also, I think it's important to set the record straight about the facts of postwar inflation itself as well as its causes. You know the inflation ended in 1947. From 1948 until the Korean war, prices were very stable even though the Fed continued to peg the Government bond market. If we are to draw any conclusion about monetary policy during the 1948-50 period, the conclusion we must draw is that money was too tight, not too loose. The volume of money was almost constant from 1947 to the Korean war, as were prices. On the other hand, unemployment rose, especially in 1949, and that would indicate to me that money was then too tight.

During the 12-year period we first experienced a severe depression, then a severe war, the greatest in our history, and after the war we had problems of reconversion, of pent-up demand inflation, and later of the 1949 recession and, of course, the cold war. Notwithstanding all that, the monetary authorities were successful in keeping the Government from paying more than 2½ percent interest and during that time bonds never went below par. Now that is pretty good. If you can do that during that 12-year period, 12 of the hardest years in the history of our Nation, why can we not do it now? Why should we have the Government pay as much as the going rate of interest when all money and credit is backed by the Government?

In fact, it is so well backed by the Government, that if a person refuses to pay his part of the taxes to take care of the interest on these Government obligations or to pay these Government obligations the U.S. marshal can take the coat off his back, if he is wearing it, and if he can get it off his back, or his shoes, or his homestead—no exemption of any kind whatsoever, to carry out the policy of this Government of paying its debts and its interest. So when that credit is used for that purpose, it occurs to me that the Government should not have to pay as much interest as the ordinary corporation. Do you agree to that, Dr. Lerner?

Dr. LERNER. No; I do not agree with that.

The CHAIRMAN. How do you stand, Dr. Bach? Do you think the Government should pay the same going rate of interest?

Dr. BACH. I don't think it should pay the same going rate of interest. I do not think it has to face the fact that it cannot maintain its interest rates severely out of line with the market for very long. And if one goes back to your example, it is true, I believe, that as the Government kept the long rate down to 2½ percent during that period you referred to, in effect it put so much money in the economy that it did keep down the market rate paid by nongovernmental borrowers.

The CHAIRMAN. I will place in the record at this point a statement from 1919 to 1964 by months of the interest rates on long-term Government bonds. It will really amaze you. I place it in at this point.

(The information referred to follows:)



## Yields on long-term Government bonds, by months, 1919 to present

[Percent per annum]

	January	February	March	April	May	June	July	August	September	October	November	December	Year
1919	4.63	4.70	4.73	4.72	4.67	4.69	4.72	4.78	4.73	4.71	4.81	4.90	4.73
1920	4.93	5.05	5.09	5.28	5.58	5.54	5.57	5.67	5.43	5.08	5.21	5.40	5.32
1921	5.23	5.28	5.27	5.24	5.25	5.27	5.26	5.22	5.12	4.83	4.64	4.47	5.09
1922	4.45	4.50	4.41	4.41	4.26	4.24	4.14	4.12	4.19	4.30	4.33	4.32	4.30
1923	4.32	4.33	4.38	4.39	4.37	4.34	4.34	4.35	4.36	4.40	4.37	4.35	4.36
1924	4.30	4.28	4.28	4.23	4.15	3.98	3.94	3.91	3.92	3.87	3.90	3.96	4.06
1925	3.96	3.95	3.96	3.93	3.87	3.79	3.79	3.85	3.85	3.82	3.79	3.80	3.86
1926	3.77	3.71	3.71	3.70	3.67	3.67	3.68	3.70	3.68	3.68	3.62	3.56	3.68
1927	3.51	3.48	3.37	3.35	3.31	3.34	3.36	3.32	3.30	3.29	3.23	3.17	3.34
1928	3.18	3.19	3.17	3.20	3.24	3.23	3.42	3.48	3.46	3.47	3.33	3.45	3.33
1929	3.52	3.62	3.74	3.64	3.64	3.69	3.64	3.71	3.70	3.61	3.35	3.36	3.60
1930	3.43	3.41	3.29	3.37	3.31	3.25	3.25	3.26	3.24	3.21	3.19	3.22	3.29
1931	3.20	3.30	3.27	3.26	3.16	3.13	3.15	3.18	3.25	3.63	3.63	3.93	3.34
1932	4.26	4.11	3.92	3.68	3.76	3.76	3.58	3.45	3.42	3.43	3.45	3.35	3.68
1933	3.22	3.31	3.42	3.42	3.30	3.21	3.20	3.21	3.19	3.22	3.46	3.53	3.31
1934	3.50	3.32	3.20	3.11	3.02	2.98	2.92	3.03	3.20	3.10	3.07	3.01	3.12
1935	2.88	2.79	2.77	2.74	2.72	2.72	2.69	2.76	2.85	2.85	2.83	2.83	2.79
1936	2.80	2.77	2.71	2.68	2.66	2.66	2.65	2.61	2.60	2.62	2.53	2.51	2.65
1937	2.47	2.46	2.60	2.80	2.76	2.76	2.72	2.72	2.77	2.76	2.71	2.67	2.68
1938	2.65	2.64	2.64	2.62	2.51	2.52	2.52	2.51	2.58	2.48	2.50	2.49	2.56
1939	2.47	2.44	2.34	2.30	2.17	2.13	2.16	2.21	2.65	2.60	2.46	2.35	2.36
1940	2.30	2.32	2.25	2.25	2.38	2.39	2.28	2.25	2.18	2.10	1.97	1.89	2.21
1941	1.99	2.10	2.01	1.96	1.92	1.91	1.90	1.94	1.94	1.88	1.85	1.96	1.95
1942	2.48	2.48	2.46	2.44	2.45	2.43	2.46	2.47	2.46	2.45	2.47	2.49	2.46
1943	2.46	2.46	2.48	2.48	2.48	2.45	2.45	2.46	2.48	2.48	2.48	2.49	2.46
1944	2.49	2.49	2.48	2.48	2.49	2.49	2.49	2.48	2.47	2.48	2.48	2.48	2.48
1945	2.44	2.38	2.40	2.39	2.39	2.35	2.34	2.36	2.37	2.35	2.33	2.33	2.37
1946	2.21	2.12	2.09	2.08	2.19	2.16	2.18	2.23	2.28	2.26	2.25	2.24	2.19
1947	2.21	2.21	2.19	2.19	2.19	2.22	2.25	2.24	2.24	2.27	2.36	2.39	2.25
1948	2.45	2.45	2.44	2.44	2.42	2.41	2.44	2.45	2.45	2.45	2.44	2.44	2.44
1949	2.42	2.39	2.36	2.38	2.38	2.38	2.27	2.24	2.22	2.22	2.20	2.19	2.31
1950	2.20	2.24	2.27	2.30	2.31	2.33	2.34	2.33	2.36	2.38	2.38	2.39	2.32
1951	2.39	2.40	2.47	2.56	2.63	2.65	2.63	2.57	2.56	2.61	2.66	2.70	2.57
1952	2.74	2.71	2.70	2.64	2.57	2.61	2.61	2.70	2.71	2.74	2.71	2.75	2.68
1953	2.80	2.83	2.89	2.97	3.11	3.13	3.02	3.02	2.98	2.83	2.88	2.79	2.94
1954	2.69	2.62	2.53	2.48	2.54	2.55	2.47	2.48	2.52	2.54	2.57	2.59	2.56
1955	2.68	2.78	2.78	2.82	2.81	2.82	2.91	2.95	2.92	2.87	2.89	2.91	2.84
1956	2.88	2.85	2.93	3.07	2.97	2.93	3.00	3.17	3.21	3.20	3.30	3.40	3.08

1957	3.84	3.22	3.26	3.32	3.40	3.58	3.60	3.63	3.66	3.73	3.57	3.30	3.47
1958	3.24	3.28	3.25	3.12	3.14	3.20	3.36	3.60	3.75	3.76	3.70	3.80	3.43
1959	3.91	3.92	3.92	4.01	4.08	4.09	4.11	4.10	4.26	4.11	4.12	4.27	4.08
1960	4.37	4.22	4.08	4.18	4.16	3.98	3.86	3.79	3.84	3.91	3.93	3.88	4.02
1961	3.89	3.81	3.78	3.80	3.73	3.88	3.90	4.00	4.02	3.98	3.98	4.06	3.90
1962	4.08	4.09	4.01	3.89	3.88	3.90	4.02	3.98	3.84	3.89	3.87	3.87	3.95
1963	3.89	3.92	3.93	3.97	3.97	4.00	4.01	3.99	4.04	4.07	4.11	4.14	4.00
1964	4.15												

NOTE.—Long-term Government yields from January 1919 through Oct. 14, 1925, are unweighted averages of yields of all outstanding partially tax-exempt Government bonds, due or callable after 8 years, and those from Oct. 15, 1925, through December 1941 of all such bonds due or callable after 12 years. Averages for the 2 sets of bonds were identical from Oct. 15, 1925, through July 16, 1928. Beginning January 1942 through Mar. 31, 1952, yields are based on taxable bonds neither due nor callable for

15 years; beginning Apr. 1, 1952, through Mar. 31, 1953, on bonds neither due nor callable for 12 years. From Apr. 1, 1953, to present, series based on bonds maturing in 10 years or more.

Source: Board of Governors of the Federal Reserve System, "Banking and Monetary Statistics," 1953; Annual Report of the Secretary of the Treasury, 1958; and Treasury Bulletins.

The CHAIRMAN. I also place in the record at this point a statement prepared by the staff commencing from 1946, a year after the war was over, of course, stating for the years 1946 to the end of 1963 the size of the national debt and the actual interest, lump sum, paid per year, and then what both the debt and the interest payments would have been if we had paid interest on the debt at the rate that prevailed in 1946 and used the saving in interest to repurchase debt.

You will find that if we had paid the same rates, the same rates that we paid from 1939 at the start of the emergency in Europe through that depression and through that Great War, and after it was successfully concluded in 1945, if we had maintained the same rates, then we would have saved \$40 billion. In other words, our national debt would have been \$270 billion instead of \$310 billion.

I place that in the record at this time. I want also to add that in my opinion this needn't have been inflationary. Surely smaller deficits would not have been inflationary; as I have just finished saying, the inflation we had after the war was mostly due to the increase in the money supply during the war, not to low interest rates after the war. During the early part of the Korean war there was again a very rapid increase in the volume of money. But the Fed could easily have prevented this just by raising bank reserve requirements. When the Fed finally got around to doing this in the winter of 1951, the Korean war inflation was quickly ended and without any great increase in interest rates. Tight money and high interest policies were not really put into effect until after 1952. There is no proof whatever that these policies were needed to prevent inflation. If there was a threat of inflation, the Fed should not have cut bank reserve requirements as they did. Since 1952 reserve requirements have been cut nearly in half when you consider they now commingle time and demand deposits and count vault cash as reserves. Tight money and high interest rates were used together with lowering bank reserve requirements not to fight inflation—for lowering reserve requirements would tend to cause inflation—but to increase bank earnings. Every sophisticated economist and banker knows that if you want to increase bank earnings the way to do it is to both increase interest rates and lower reserve requirements. So the tight money policies we had these past 10 years just can't be excused by saying they were necessary to fight inflation. They did not contribute to the taxpayers' welfare. The tight money policies caused three recessions and because of these recessions we had in 1953-54, again in 1957-58, and then in 1960-61, we had to run very big budget deficits. If we had had an easier money policy and lower interest rates we would have full employment and so saved even more than \$40 billion. In other words our debt would be even less than \$270 billion, and a lot less.

(The document referred to follows:)

[Billions of dollars]

	Actual interest paid	Actual debt	Reduced debt	1.8 percent in reduced debt	Budgetary saving
1946-----	4.8	269.4	-----	4.8	0
1947-----	5.0	258.3	-----	4.6	.4
1948-----	5.3	252.3	251.9	4.5	.8
1949-----	5.4	252.8	251.6	4.5	.9
1950-----	5.8	257.4	255.3	4.6	1.2
1951-----	5.7	255.2	251.9	4.5	1.2
1952-----	5.9	259.1	254.6	4.6	1.3
1953-----	6.6	266.1	260.3	4.7	1.9
1954-----	6.5	271.3	263.6	4.7	1.8
1955-----	6.4	274.4	264.9	4.8	1.6
1956-----	6.8	272.8	26.17	4.7	2.1
1957-----	7.3	270.5	257.3	4.6	2.7
1958-----	7.7	276.3	260.4	4.7	3.0
1959-----	7.7	284.7	265.8	4.8	2.9
1960-----	9.3	286.3	264.5	4.8	4.5
1961-----	9.0	289.0	262.7	4.7	4.3
1962-----	9.2	298.2	267.6	4.8	4.4
1963-----	10.0	305.9	270.9	4.9	5.1
Total saved-----	-----	-----	-----	-----	40.1

The CHAIRMAN. I think there is a big difference in what the Government should pay and what the private corporations or individuals should pay.

The Government, as I said, permits the creation of the money. It occurs to me that when a government will make these reserves available to banks free, the banks certainly in acquiring the Government obligations should not require the Government to pay the same going rate as private corporations pay. Now, you know that we have about \$17 or \$18 billion in bank reserves in these 12 Federal Reserve banks.

New York probably has near \$5 billion—to be exact—New York had about \$4,644 million at the end of 1962. Probably more at the end of 1963. This is around \$5 billion. Other banks like Boston around \$829 million and Philadelphia \$825 million. Cleveland has a billion two hundred and one million and all the others in proportion.

You know, if you were to go into one of these Federal Reserve banks and asked the President, "I want to see the reserves that you are holding here for your member banks," the President of that bank would have to tell you, "Professor, we do not actually have any reserves, that is only a bookkeeping entry."

Some people would expect to find a pile, a stockpile of gold and silver and currency and bonds and everything else. They would think so but there is nothing. Absolutely nothing. They are using the credit of the Nation behind their reserves, that is all.

You know how it works, Professor, and you, too, Dr. Lerner. I know that you do. The banks pay nothing for this, absolutely nothing—the way they get it. For instance, when a customer wants to sell a million dollars in bonds, the bank will sell the bonds to the Federal Reserve bank. The Federal Reserve bank just creates the money or goes over to the Bureau of Engraving and Printing and gets out a million dollars' worth of money.

Now, of course, the bank does not need the actual money for the customer. The bank just needs the right to have it and so they increase their total reserves \$1 million just by reason of that one customer's action. Now, the bank gives that customer credit for \$1 million, then it makes loans and investments to the extent of its excess reserves. Ultimately, the banking system expands loans and investments \$9 million more—\$9 million more. In other words, \$10 million on that \$1 million. And they are using the Government's power to create money free.

Now, I would like to ask you one question. In the New York Federal Reserve Bank they hold about \$32,900 million in bonds. That is the portfolio for all the 12 banks, of course. Those bonds have been acquired just like I stated here. If the Fed has bought them and paid for them with another Government obligation, do you think that those bonds having been paid for once should be continued—should continue to be carried as a part of the national debt? Is it right when we took one form of Government obligation, Federal Reserve credit to be exact, traded it for another, got the other, that is the interest-bearing Government bonds, is it right to continue to make the taxpayers of the country pay interest on those bonds that have been paid for once? How do you feel about that, Dr. Bach?

Dr. BACH. May I answer your question in three parts?

First, I think they should be continued to be called part of the national debt insofar as they are part of the national debt which they legally are at this points. I think the people of the United States should know there is an obligation.

Now, the essence of your argument is that they should not be in the present form, that in fact it is foolish for the Government to issue interest-bearing bonds to the Fed. I do not consider this a matter of great substance. As you know very well, Mr. Chairman, the Fed gives back the bulk of its earnings, 90 percent of them into the Treasury at the end.

The CHAIRMAN. After spending everything they want to from the billion a year they get in interest. The taxpayers have paid it and the taxpayers have turned it over. Now, they spend that exactly as they want to without any accounting to anybody. No appropriations committee, no audit. Fifty years, no audit. Then, after they spend everything they want to they turn the rest over into the Treasury. Do you consider that a good deal for the people, Doctor?

Dr. BACH. I don't think it a bad deal for the people on the evidence, and my test of whether it is a good deal or a bad deal is whether the people get their money's worth out of it, if I may put it that way.

My own assessment is that the Fed has been run by honest and competent people, and certainly people who have not played fast and loose in my judgment with the taxpayers' money, if you want to call it the taxpayers' money.

My own assessment partly is made as an employee of the Federal Reserve for some time and partly as a director of one of the Federal Reserve branches, and that assessment is that the Fed does exercise very prudent care with these expenditures.

The CHAIRMAN. We do not know. There has been no audit except their own audit. Do you think it is sensible for the Congress of the United States to let people, many of whom have a selfish interest, selected by the bankers to be on these boards, to determine how much the volume of money will be and how much interest rates will be? They have tremendous power, these men selected by bankers, and their recommendations usually prevail.

Do you think that ought to go on year after year, 50 years and even more and the Government never had any audit at any time?

Dr. BACH. In my judgment it is important to distinguish between the two points you have just made.

So far as the issue of whether the Fed wastes money in the sense of paying too big salaries or having too much stationery printed or whatever particular matters or that kind are concerned, I am not personally concerned that the Fed is wasteful of the funds.

The issue is as to whether there should be an audit from within the Government seems to be an issue of principle. My answer is I do not believe there should be for the following reason: In establishing the Federal Reserve in its present form the Congress has said to the Fed, we want a group of men who stand apart from the day-to-day pressures of the Congress, the President of the United States, and the Secretary of the Treasury. To establish an audit in the sense that I believe you are suggesting would, it would seem to me, be an entering wedge to remove that degree of separateness of degree of independence that I think the Congress wanted to establish in the Fed.

Now, I think the other half of your question, however, raises a much bigger issue and that is the whole issue as to whether there should be a group of men nominated by the President and approved by the Senate who are independent to the extent that the Fed is. They do have the power over the stock of money. You are completely right about that. They do have this. That is what we were talking about a few moments ago when we discussed the whole independence of it.

I was arguing, and I would repeat, that I think it is appropriate for the Congress of the United States to delegate to the Federal Reserve the day-to-day management of the money supply, under the kind of responsibility that is generally provided in the Employment Act of 1946.

The CHAIRMAN. I must call your attention to this. You are saying exactly what I am saying in these bills, to let representatives of the people, selected by the President and confirmed in the Senate control this. But that is not the way it is. That is not the way it is. That is the way it used to be. But that was changed when we became a central bank in 1933 and the 1935 act. Now, you see these 12 men that control that supply of money, they meet in secret every 3 weeks down here at the Federal Reserve Board. They do not let the Congress or the President or anybody know what they are doing.

Who are these men that do that? There are really 19. Some seven of them are members of the Board. They are the people you are talking about and that I want to confine it to. But it is not just these seven men. When they walk into this room 12 other fellows come in with them. Who are they? They are Presidents of each one of the 12 Federal Reserve banks. They were selected by a board of directors of their respective banks.

Who are the men on these boards of directors? Six of them are selected by the banks themselves and three of them are selected by the President. So you know that the directors select people that the banks want. No one would contend that they would think about anything else and those 12 Presidents selected by the representatives of the bank are going into this secret chamber where only public men, public representatives should be, as you described a while ago. But they are there, too, to help make monetary policy and determine interest rates. It is to their benefit to have high interest rates.

Sometimes it is in their interest to have a depression, get property in stronger hands, transfer, squeeze somebody. Sometimes they need inflation to carry their point. They are in a position to do it. Now, while you are insulating these public members, as you say against the electorate and against public pressure, why do you not think that they should also be insulated against the bankers? What do you think about that, Dr. Bach?

Dr. BACH. If I believed that your description of Federal Reserve operations is accurate I would agree with your conclusion. If I believed that bankers did dominate the conclusions of the Open Market Committee I would agree completely that we need to change the situation and to change it immediately.

The CHAIRMAN. Doctor, how can you argue anything else when you have got 12 men selected by private bankers there to 7 public members? And these men must also confer with private bankers from each of the Federal Reserve districts so often each year and give consideration to the recommendations they make, so you have got them surrounded by bankers from all over the Nation, that they are compelled to listen to their recommendations. No body else is given that privilege, only the bankers are allowed to do that and they are the ones who can benefit the most. Do you not think it should be like the Interstate Commerce Commission where we do not allow anybody to influence policy who is connected with transportation, whether railroads or trucks or ships? They should not be there. And the same goes for the Federal Communications Commission—would you argue that the broadcasting companies should appoint the Commissioners who determine the rules for the broadcasting business? But this is the same thing as we are doing in the Federal Reserve.

Mr. BOLTON. Will the gentleman yield?

The CHAIRMAN. Certainly.

Mr. BOLTON. Who would you place on the Board then?

The CHAIRMAN. Public members. I am not saying the present members would not be good ones. I am not saying that. But I am saying they should not be surrounded by men appointed by bankers who obviously let bankers look over their shoulders at everything they do and influence their decisions that are made in the very secret meetings that they have.

Mr. BOLTON. Mr. Chairman, if you are going to appoint people with financial knowledge and interest, unless you took them from the educational field, where would you get such a group?

The CHAIRMAN. Mr. Roosevelt, Franklin D., had that very problem and he finally got them from universities and colleges of the country, most of them. Because that is the only place he could turn to, where you get the knowledge and information and unselfish service. He could not afford to pick them from industry every time and there are plenty of people available that are not necessarily connected with the banking business.

Mr. BOLTON. But it has been demonstrated here in the past week by testimony by members of the educational group that there are—that these gentlemen would be just as biased and just as dogmatic as any member of the financial community.

The CHAIRMAN. It is possible. But the President also could appoint bankers. The point is that so long as he appointed them they would be public servants. As it is now, my dear sir, these 12 Presidents of the Federal Reserve banks, evidently, they do not feel any obligation to the Government. They do not even take an oath to support the Constitution. They do not take an obligation to support the Government of the United States. They do not take an oath as President of the bank—none.

Now, after they become a member of the Open Market Committee, then they become—in other words, they have another hat to put on. Then they take an oath under that hat. But not as Presidents of the Federal Reserve banks. So they do not even obligate themselves, regardless of what they do. You cannot charge them with anything because they have not obligated themselves to do anything. That has gone on for decade after decade here in this country.

It occurs to me that Congress has been rather loose in dealing with a most important matter affecting our country. It is because of this that I advocate that every Member of the House have two administrative assistants, at least somebody like a good lawyer or an economist or somebody in that category, men who have knowledge and information and can help the Members.

The interest of our constituents is our first obligation we feel. In doing that some Members find it necessary to go to cocktail parties and banquets nearly every night and so they cannot look after finding out what these and other bills provide. They just cannot do it and I am not blaming them because whenever they look out for their constituents they do not have time for it. But they ought to have a couple of fellows right next to them in whom they have confidence and trust. That is the reason I favor that.

The fellows would save thousands of dollars for every \$1 we spend that way. The Members just cannot function like it is.

Now, I have heard Members say, all I know about money is I just do not have enough of it. They just throw it off with a wave of the hand. They do not have time. But the time has come when, if Members do not wake up and study this question of interest rates and things, we will not have a \$300 billion debt, we will have a \$600 billion debt and before you know it. Why should we not? Because the people who have charge of it can make money out of it. Their inventory does not cost them anything. They get their money free. They get it



from the Government, collect the interest. Why should they not want more obligations and higher interest rates?

When interest rates were low we had a lot of people who wanted to pay off the bonds but now we do not have anybody who wants to pay them off. They want more bonds at higher rates.

Mr. BOLTON. Mr. Chairman, again, I apologize to the chairman. But he and I disagree very strongly on this. I can only answer—I would like to ask him a question. How can you avoid having a debt if you spend more than you take in?

The CHAIRMAN. You cannot. But as long as you keep piling up the interest rate and this table I put in there will show you since World War II if we had kept the same rates that we had at the end of the war in 1946, a year later, our national debt today would be \$40 billion less and one of these days—

Mr. BOLTON. Who would you have buy the bonds?

The CHAIRMAN. At 2½ percent you have plenty of market, you had a good market for bonds.

Mr. BOLTON. Because that was the competitive rate at that time.

The CHAIRMAN. It was Government bonds.

Mr. BOLTON. How can you force somebody to take a bond if they do not choose to?

The CHAIRMAN. That problem has never presented itself. If that problem were to arise it could be dealt with. The Federal Reserve could buy them and when the Federal Reserve buys them and the interest rate flows back over into the Treasury and saves the taxpayers that much money.

There is not a bond held by commercial banks today that the Federal Reserve could not buy if they wanted to.

Mr. BOLTON. The gentleman's experience is a great deal longer than mine, but I can remember sitting here at this same table in the year I believe 1954 with the gentleman, when the Treasury issuance was then discussed with the then Secretary of the Treasury and the rate at which the bonds would be issued was discussed and there was a very major point made that it would be dependent on what the market would take.

The CHAIRMAN. That is one way to look at it if you are not looking at the people's interest. But if we are trying to help the taxpayer you can see we are going to fix the rate. We will fix it at 1.99 or 2.99, 3.01, or 2.01—any rate that we want the Federal Reserve can keep it there.

Mr. BOLTON. Are you also going to fix the discount?

The CHAIRMAN. Not the Congress, but the Federal Reserve can fix the discount. Of course, the discount windows are practically closed.

Mr. BOLTON. Therefore if you had a bond which you wanted to sell at 1 percent and the going rate in the marketplace was 3½ or 4½ percent—

The CHAIRMAN. You would have to take a discount.

Mr. BOLTON. Either a discount, which means you would get less money in the Federal Treasury for the bond or the Federal Reserve would have to purchase all those bonds, is that right?

The CHAIRMAN. No Government bonds are selling at lower than 1 percent.

Mr. BOLTON. I agree with that. But the illustration is illustrative.

The CHAIRMAN. But it is not pertinent.

Mr. BOLTON. You suggested setting an interest rate. What difference does it matter whether you set it at 1 percent or 3 percent if the 3 percent is below the interest rate which the market has?

The CHAIRMAN. We did over a period of 12 years without loss for the country, the Government. Would you like to say something, Doctor?

Dr. BACH. Mr. Chairman, I think if you want to carry your argument a little further you can point that the policy of maintaining the interest rate at 2½ percent would have in some sense saved the taxpayers a great deal more. Because if my answer to Mr. Brock was correct, we would thereby have had a large amount of inflation. Of course, the purchasing power of the debt would have gone down drastically. Perhaps you are right on the \$40 billion calculation, so you would have had only a \$260 billion debt instead of \$300 billion debt. But even more, to pay off the \$260 billion debt would have taken a much smaller amount of purchasing power.

The CHAIRMAN. We would have had full employment, not inflation, and so we would have greater earnings of the people, from which tax—from which greater taxes would have been collected. We would have had to spend less money on unemployment and other programs. And remember we didn't have to lower bank reserve requirements as the Fed did after 1953.

Mr. BROCK. Will the gentleman yield?

The CHAIRMAN. Yes.

Mr. BROCK. If we had held a false ceiling of 2½ percent from 1951 on, and if, as Dr. Bach suggested we had tremendous inflation you might have saved \$40 billion in the national debt. If we had 100 percent inflation we would have cost the American people over \$200 billion a year in purchasing power.

The CHAIRMAN. Keeping the interest rate was not going to cause inflation—not the Government rate. Now, of course, other rates could have entered into it.

Mr. BROCK. Would the chairman yield further?

The CHAIRMAN. Yes.

Mr. BROCK. I would like to ask Dr. Bach if there is not a direct causal relationship between the fixed Government rate and the rest of the interest rates in the country, private interest rates?

Dr. BACH. Not a fixed relationship, but there is a demonstrable relationship that the only way the Government could keep on paying a 2½-percent rate over that long period of time would have been to put lots more money into the system through putting bank reserves in the system, and that would have caused the inflation. So the interest rate per se perhaps would not have caused the inflation but the large increase in the money supply that would have been required to have maintained that low interest rate would have caused the inflation and would, as I jokingly pointed out, made it very easy to pay off the debt. It would have inflated the debt away, but I doubt many of us would have wanted that.

Mr. BROCK. If we had 100-percent inflation your cost to the American people would have been far greater than the \$40 billion we saved in the national debt.

Dr. BACH. It would have been extremely unfortunate had we had that much inflation; yes.

Mr. BROCK. Mr. Chairman, if I may, I have an article here which I would like to have inserted.

The CHAIRMAN. Certainly. It may be inserted at this point in the record.

(The clipping from the Wall Street Journal, dated March 9, 1964, referred to follows:)

[From the Wall Street Journal, Mar. 9, 1964]

#### JOHNSON AND MARTIN—VARIED FORCES COULD PROPEL THEM TOWARD A CONFLICT

(By Richard F. Janssen)

WASHINGTON.—When will William McChesney Martin clash with Lyndon Baines Johnson?

The question recalls one widely asked in 1961: "When will William McChesney Martin clash with John Fitzgerald Kennedy?" The young President who had campaigned on the pledge that "tight money" must not be permitted to choke economic growth then confronted a Federal Reserve Board Chairman determined that "easy money" must not be permitted to force inflation or trigger a run on U.S. gold.

As it turned out, of course, the answer of history to the 1961 query was "never." Both men rather expected a clash. But in the end, neither could see anything to gain by it. Each adjusted a bit to the other. Mutual suspicion turned to respect with the liberal President reappointing the conservative central banker to the chairmanship.

Yet the negative answer to the question of a Martin-Kennedy clash, though final, seemed, paradoxically, a little less than conclusive. Perhaps the encounter never occurred mainly because the economy never worked up enough steam. If it had built more pressure under prices and wages, Mr. Martin might well have felt compelled to encourage money tightening that would have outraged Mr. Kennedy.

Again, there's a new President. Again, a question is appropriate. While he may not have Mr. Kennedy's theoretical commitment to easy money, Mr. Johnson does have a Westerner's instinct for it. And visible on the horizon are forces which could push both him and Mr. Martin toward conflict.

If the \$11.5 billion tax cut performs as advertised, greater demand for goods and workers could soon push those prices and wages. Prosperity tends to bid up the price of money, too, as business borrows for working capital and expansion. If interest rates do rise in response to such demand, Mr. Martin could prove disinclined to do anything to stop the climb.

#### JOHNSON'S WARNING

As if anticipating this, Mr. Johnson has already warned the Board publicly that "it would be self-defeating to cancel the stimulus of tax reduction by tightening money." Administration officials figure that in warding off recession from now on heavy reliance must be upon a rather relaxed money market—because the tax-cutting tool has already been used, and the spending-hike tool is less available, too, with tax reduction limiting revenues.

But balance-of-payments considerations could be another force impelling the Board toward higher interest rates. If Britain's recent interest rate hike lures more U.S. dollars overseas, the Federal Reserve fear that many of them may be used to buy Yankee gold may grow—enough to tip a similar decision here.

The Board's vaunted independence from the executive branch legally prevents the President from simply ordering it to get in line with White House policy. But if L.B.J. happens to decide he's ready for a fight, he could demand that Congress change the law. He would find an array of such schemes handy on the shelf; they are already being displayed by a fellow Texas Democrat, Wright Patman, in his House Banking Committee's hearings on the Federal Reserve.

Mr. Patman's ideas are simple enough. He wants to slice the terms of Board members to 4 years, so each President could name his own Board. He would make the Fed come to Congress for its operating funds, rather than living off the system's earnings.

And there is no question this would rob Mr. Martin and company of their cherished independence. Their insulation from White House dominance comes from 14-year terms, staggered so that one expires every second year. Though the President appoints members with the consent of the Senate, no President now can quickly stack the Board with men whose views match his own.

#### THE CASE FOR INDEPENDENCE

Preserving this is vital, Board members argue; otherwise, a President might be tempted, by short-run political advantage, to have the Board pump out so much money that boom would be followed by inflation and bust. Short of so hideous a peril, they feel it's valuable to the President to have economic advice from at least one set of officials who aren't directly dependent on his pleasure to keep their jobs.

Such logic may or may not carry weight with Lyndon Johnson. But if he ever comes to the point of considering an open dispute with the Fed, another more forcible sort of logic will come into play. The plain fact of the matter is—as Mr. Kennedy came to realize—that any President who buys a fight with Mr. Martin buys political trouble.

Not that the soft-voiced gentleman over at the Fed boasts any political machine, but he has become a symbol. If he were forced out of his post—or just irritated into indignant resignation—the impact upon this administration could be profound.

A President Johnson who enjoys much business support would almost certainly find a clash with Mr. Martin producing an instant enragement of businessmen, more universally than did the Kennedy clash with the steel companies. Republicans would be handed on a platter their first convincing case that this Democrat has no sense of economic responsibility.

Even wider and worse political damage could come by indirection, smashing in on the administration in a rapid second wave. For Mr. Martin is a symbol, too, to many foreigners. His departure would almost certainly be viewed by jittery European central bankers as repudiation of the sound dollar. Despite the defenses erected in recent years by the Treasury and Federal Reserve, a run on U.S. gold could start and quickly feed on its own panic, draining the U.S. hoard and thus undoing a mainstay of the world's economy. How would that look to the voting public around election time?

So here is the answer to that question: Lyndon Johnson will clash with Bill Martin only when and if he becomes a desperate man. But this does not imply inaction.

It is much more likely that the President will employ instead the highly developed Johnson art of friendly persuasion. Although Mr. Martin is a man of firm convictions, and much inclined to worry about inflation, he is not immovable. He has, in fact, proved adaptable, serving during the quite different regimes of Presidents Truman, Eisenhower, and Kennedy.

To date, it's apparent that President Johnson and Mr. Martin haven't developed the rapport which Mr. Kennedy and the Chairman clearly had. But during the first 6 months of the Kennedy administration, rapport didn't exist either. By the time Mr. Johnson has been in office that long, associates think a good working relationship may be built up again.

So far the Martin encounters with the new President have been scanty, inconclusive. The President has had an hour-and-a-half chat, described as affable, with the Chairman. A few phone calls and brief social encounters have occurred. Actually, the sensation at the Federal Reserve, as in other financial and economic arms of the Government, is not at all one of current tension—but on the contrary a somewhat "left out" feeling. Folks get the idea Mr. Johnson is not fascinated by their problems, and may never develop Mr. Kennedy's degree of interest in such things.

#### ANOTHER TACTIC POSSIBLE

In calculating how to deal with Mr. Martin, a President can consider not only collision and persuasion but one other possibility: erosion.

Mr. Martin isn't the whole Federal Reserve Board, and the rest of it is something less than monolithic. It's becoming increasingly apparent that some men on the Board share the view of outside critics—that the majority has become so imbued with its sound-dollar role that it shortchanges domestic growth by keeping money too dear. On these grounds, J. L. Robertson last summer voted against a hike in the discount rate, made to discourage the outflow of U.S. capital

to other nations. Abbot Low Mills has been favoring a greater degree of "monetary ease" in recent Board deliberations, and George W. Mitchell often talks like a "liberal."

It was, significantly, Mr. Robertson whom the President did reappoint to a full 14-year term over the weekend, a move that was quite cheering to Board officials. Mr. Robertson's previous partial term ran out at the end of January. The move suggests that the President considers it important to build his rapport with the Board by retaining a very highly regarded incumbent. The reappointment scotched, at least for the time being, some worries that the President may be tempted to name someone clearly identified with labor or consumer interests to the Board. This might have stirred unrest within the Board and lessened confidence in it and the dollar, both by inflation conscious foreigners and the domestic business community.

But because Mr. Robertson has been favoring easier money than the majority and is an outspoken defender of small banks against the merger advances of big ones, the appointment certainly isn't lacking political benefits on the liberal side, either.

In choosing Mr. Robertson, the President passed up an opportunity to support Mr. Patman's campaign to bring the Board under closer White House control. One of those under consideration for the seat was Seymour Harris, believed to have been President Kennedy's choice. The former Harvard professor, long a student of the Board, has publicly decried its independence as "absurd," wrongly depriving the President of the full ability to carry out his responsibilities in economic policy.

There is a natural tendency of Presidents, of course, to appoint somebody of the most political value. But the Board has been successful in the past in blocking purely political appointments. Mr. Kennedy once handed a name to Mr. Martin, who checked the man and found him wanting. President Kennedy, the story goes, agreed good-naturedly the fellow's chief qualification was that he'd "carried a State for me"; the President chose instead another candidate quite acceptable to Chairman Martin.

#### ORIGINAL CONCEPT FADING?

Mr. Johnson's first appointment doesn't lessen concern of some sources close to the Board about a long-run trend away from the original concept of a Board of businessmen, financiers and farmers. The Board is becoming weighted with professional economists, college professors and career civil servants. There's no doubt they have technical skills useful in increasingly delicate and complex evaluations the Board must make of domestic and international financial problems. But some would feel more comfortable if there were more of a mix.

There's worry inside the Fed, as well as outside, that the Board is getting short on "practical" experience in how the private enterprise sector really works. Several vacancies over the next few years will provide a chance for the trend to be continued or reversed. Even now, some argue, the Board has no member identifiable as completely a businessman; the last of the breed was George H. King, a Mississippi lumber and cattle magnate, who resigned last September.

President Kennedy used that opening to appoint J. Dewey Daane, a career Federal Reserve economist and Treasury debt manager. The only other Kennedy appointment to the Board was Mr. Mitchell, an economist from the Chicago Federal Reserve Bank. C. Canby Balderston, a Board governor since 1954, is another economist, who became dean of the Wharton School of Finance and Commerce.

Chairman Martin is so widely respected as watchdog of the economy that many assume he is an economist—but he isn't. A stockbroker in the 1930's, Mr. Martin was a St. Louis Federal Reserve Bank examiner, president of the New York Stock Exchange, and Assistant Secretary of the Treasury. Mr. Robertson was a Treasury civil servant who specialized in bank regulating. Charles N. Shepardson was dean of agriculture at Texas A. & M. College. The only banker left on the Board is Mr. Mills, who was a Portland, Oreg., bank vice president and director.

All in all, the prospects are that independence of the Federal Reserve from the more politically attuned centers of Federal power will neither be lost nor saved completely any day soon. But a single day could bring at least some behind-scenes showdown and compromise over interest rates. Another could bring appointment of a member who at least privately doesn't hold central

bank independence high among his tenets of financial faith. Ultimately, Mr. Martin will depart, when his term runs out in 1970 or earlier if he tires of the fight. Together, such days could go a long way toward determining whether the Board's independence is preserved or destroyed. And whether historians will say that it happened with a roll of thunder or hardly a whisper.

The CHAIRMAN. The reserve requirements, you know, they were lowered about 50 percent from 1953 to now. You see, it looked to me like that would have caused the same inflation that you mentioned a while ago, if what you believe were true. And if there was such a threat of inflation from lower interest rates the Fed could have raised reserve requirements.

We do not want inflation. But I am getting pretty tired of everything coming up—I am not talking about you now—every time they want to raise interest rates they say they are afraid of inflation, afraid of inflation. The result is the people pay higher interest rates all the time and it is getting up now to where it is really a large item in our cost of living.

Then after that inflation argument was worn threadbare and they could not possibly in good conscience and with a straight face say that inflation was here or just ahead then they said it is the balance of payments that is going to ruin our country.

Then they have used that balance-of-payments argument until it got threadbare and now they are going back to inflation again. They have always got some scarecrows. But the net result is higher interest rates on the people all the time. One excuse after another. And that is the reason I want every Member of Congress to have two administrative assistants so they can help them understand what is going on.

Mr. BROCK. I completely agree with you on that.

The CHAIRMAN. Would you like to comment, Dr. Lerner, on that?

Dr. LERNER. There are quite a few things I would like to comment on.

I did say before that I disagreed with the chairman. I am not sure that this might not be slightly misinterpreted because I do find myself in great sympathy with a great deal of the argument of the chairman and certainly with his objectives. But I do have important differences and I would like to try to clear them up.

The CHAIRMAN. Yes, sir.

Dr. LERNER. I sympathize with the idea that the creation of money is enabling large profits to be made by the Reserve banks who have been given the privilege of creating money. I feel that this is not quite as bad as it sounds insofar as they hand over to the Treasury about 90 percent of what they make.

I also agree that it is desirable that there should be some check on what they spend. I had that in mind in my comments when I said I wanted to have some limitation on the spending of money by the banks other than their pride in the size of the check which they make out to the Treasury.

I did not think it a good idea to do this by having them subject to congressional appropriations authorizing their expenditures because that would give them two different masters, which is very bad. And I think it should be one of the considerations in the mind of the Executive when he appoints people to run the monetary system, that he expects them not to waste too much money. For myself I have a feeling that too much money is being spent on beautiful buildings.

But this is a separate matter and a relatively unimportant one because even if some millions of dollars or hundreds of millions of dollars are spent in this way, even that is a small matter compared to having a well-working monetary system. If there were no other way of having a well-working monetary system this cost would be worthwhile—which is what I understand Dr. Bach to say.

However, I do think we should continue to explore ways of checking on unnecessary expenditure of money, provided that there is not interference with the effectiveness of the monetary system.

But there is another point which the chairman has been raising and that is concerned with the rate of interest paid by the Government.

I do not think that the rate of interest paid by the Government can be different from the rate of interest paid in the rest of the country on bonds of equal security and reliability.

Of course, there will be different rates of interest from corporations who might go broke. You have to get a higher rate of interest to compensate for that risk. But if you can lend money with as great or almost as great a security elsewhere, nobody will lend money to the Government at a substantially lower rate of interest.

It is true that the rate of interest can be kept down—as indeed it was kept down—but this does mean increasing the quantity of money. The question then arises, should the quantity of money be increased or not and then the issue of inflation does come up as also does, unfortunately, the issue of the foreign balance.

The question can be answered only in terms of whether the increase in the quantity of money is desirable for the economy as a whole. And this is so much more important than whether the national debt is increasing or whether some people are making undue profits that one should never sacrifice the interest of the economy as a whole by holding down the rate of interest for the sake of these other considerations.

But my feeling is that the national interest has been sacrificed in the opposite direction. We have sacrificed national interest by holding the rate of interest too high.

If we want lower rates of interest we can achieve this by creating more and more money. Sometimes this takes the form of the Government having to borrow from the Federal Reserve because the public does not want to lend money to the Government at the low interest rate. I think one can make an argument for such a policy which is even more impressive than the one made by the chairman.

If we had kept on holding the rate of interest low and this resulted in inflation of the same order of magnitude as we had when we did keep the rate of interest low while prices were not controlled—namely a 70-percent inflation in 6 years—we might have got 140-percent inflation in the following 12 years. But we might have prevented this by other measures. We could have taken in order to stop the inflation. It is possible—this is the point I think which must be conceded to the chairman's position—it is possible to keep the rate of interest down and still not have inflation if you prevent the cheap money from causing too much overall spending.

The cheap money will cause investors to invest more because some investments which don't pay at 4 percent would pay  $2\frac{1}{2}$ . This increase in investment demand for goods and services need not lead to inflation if you could get a reduction in spending elsewhere sufficient

to prevent the overall demand from being greater than what the economy can provide. It is possible for the Government to, by increasing taxes and by spending less money itself, reduce other spending and thereby to set free the resources which would be needed for the additional investment.

This would mean a surplus in Government accounts, which would pay off a good deal of the national debt over and above the \$40 billion saving in interest payments stressed by the chairman.

Our question then is one that must be put not to the Federal Reserve System but to the Congress. Congress must decide if we want such an overall policy of low interest with austerity, that is with consumption spending held down, or whether we want a lower rate of interest with inflation instead. Also whether the austerity should take the form of higher taxes or of less Government services.

I do not believe that the people of this country would want either austerity or inflation for the sake of lower interest rates. I think they might even want it the other way: namely to consume more even if that meant higher interest rates. But you cannot separate the question of lowering the rate of interest from the question of the overall level of demand and of economic activity. In lowering the rate of interest paid by the Government, you cannot help making the general rate of interest equally low. You are then encouraging investment and unless there is a depression, which calls for lower interest on other grounds, you can prevent inflation only if you decrease other expenditures at the same time.

I would like to make two more points. One is on the ethics of excessively large profits being made by the banks.

I think that the way to deal with that is by the procedure which we have developed for dealing with any excessive incomes—namely by progressive income taxes.

The other point that I wanted to make is that I do not believe the bankers in the Federal Reserve System deliberately twist their advice so as to raise the rate of interest in order to increase bank earnings. I think they regard it as an honor to work for the "Fed" and they try to serve the public interest the way they see it.

I think, however, that there is good reason for doing what the chairman recommends, of having the Governors of the "Monetary Authority" consist only of people appointed as public servants, because even though the bankers do not consciously try to pervert things, they nevertheless cannot get away from their habits and prejudices as bankers which makes them tend to prefer higher rates of interest to lower rates of interest.

This is one of the reasons why we have been suffering from somewhat higher rates of interest than we should have had up to the last year or so.

As I said before, it is an accident of history that the monetary authority developed out of the voluntary action of private bankers. We must be grateful to them. But now we need a monetary authority which is free of the occupational prejudices of bankers.

The CHAIRMAN. Thank you, Doctor. We will have to close pretty soon. But I want to bring to the attention of you something that these hearings have developed. I did not realize it had gotten to such large proportions.



Of course, bankers must have deposits to make loans. They do not actually use the deposits as you know. In other words, when I go in and borrow a hundred dollars and gave them a note for it, they give me credit for a hundred dollars and they ask for the money from the Fed and they give me the \$100 in 10 \$10 bills. That has not been taken from any deposit book. That has not been taken from any assets of the bank. That is created money right there in the books.

The banks recently got into the habit of acquiring what is known as certificates of deposits. They aggregate \$10 billion now. Bankers are pretty smart.

Anything that is legal that they can do, you cannot blame them for doing it. If you go into one of the big banks in Washington or New York a banker could tell you, "Now, if you will transfer a million dollars from your demand account in some other bank over to our time deposit section, we can pay you 4 percent for that. Under the law we can do that. Then, that results in your getting \$40,000 because the bank would have to pay 4 percent for that million dollars."

There is no law violated. They can do it. They can put it over to the savings account where the reserves are only 4 percent. So the bank can lend or invest \$960,000 of the million that was just transferred into its time account and if it can do so at 6 percent, it will net nearly \$20,000, less administrative expenses.

There are a lot of things like that going on in this country right now. It is kind of fictitious manufacturing of money and creating of money. I do not know whether it is in the public interest or not. Possibly some of it is. All of it probably is not.

Thank you, gentlemen, very much. Are there any other questions? We will stand adjourned until 10 o'clock tomorrow morning.

(Whereupon, at 12 noon, the committee was recessed, to reconvene at 10 a.m., Thursday, March 12, 1964.)

# THE FEDERAL RESERVE SYSTEM AFTER 50 YEARS

THURSDAY, MARCH 12, 1964

HOUSE OF REPRESENTATIVES,  
SUBCOMMITTEE ON DOMESTIC FINANCE OF THE  
COMMITTEE ON BANKING AND CURRENCY,  
*Washington, D.C.*

The subcommittee met, pursuant to recess, at 9:30 a.m., in room 1301, Longworth House Office Building, Hon. Wright Patman (chairman) presiding.

Present: Representatives Patman, Reuss, Vanik, Pepper, Minish, Hanna, Harvey, and Brock.

The CHAIRMAN. The committee will come to order.

We have as our first witness this morning Prof. Dudley Johnson, of the University of Washington.

In view of the fact that the House is meeting at 11 o'clock, we are anxious to start as early as possible and are glad to have the cooperation of the minority members in doing so.

So, we will start now with you, Dr. Johnson, and you may proceed in your own way, sir.

## STATEMENT OF DUDLEY W. JOHNSON, PROFESSOR, UNIVERSITY OF WASHINGTON

Mr. JOHNSON. Thank you, sir.

The CHAIRMAN. We will first have your statement, and when the other witness comes, we will have his and then interrogate you.

Mr. JOHNSON. Yes, sir. I just want to say that I consider it an honor to be asked to testify before this committee.

I will be very brief, Mr. Chairman. I realize there is a session at 11 o'clock and I will submit for the record a prepared statement and now briefly summarize it.

The CHAIRMAN. That will be very satisfactory, sir.

Mr. JOHNSON. I have been asked to comment on two general questions; one, the efficacy of current monetary policy and, two, should the controlling authorities of the Federal Reserve System continue to be as independent of the executive branch of our Federal Government as is presently the case?

The CHAIRMAN. Your statement will be placed in the record at this point, so you can start from there.

(The statement referred to follows:)

CURRENT MONETARY POLICY AND THE "POLITICAL INDEPENDENCE" OF  
THE BOARD OF GOVERNORS OF THE FEDERAL RESERVE SYSTEM

(By Prof. Dudley W. Johnson, University of Washington)

I. INTRODUCTION

It is indeed an honor to be asked to participate in these hearings. I would be less than honest if I did not confess to some trepidation, knowing the names in the "batting order" of economists who have preceded me. An obvious query emerges: "What can I possibly say about the current state of monetary management that has not already been adequately said before?" However, in order to eliminate this consideration I will act as if no one has preceded me and get on with the business at hand.

I have been asked to comment on two general questions: (1) The efficacy of current monetary policy and (2) should the controlling authorities of the Federal Reserve System continue to be as independent of the executive branch of our Federal Government as is presently the case? More specifically, should the Board of Governors and Federal Open Market Committee be abolished and replaced by a new 12-member Federal Reserve Board under the chairmanship of the Secretary of the Treasury. These provisions are contained in H.R. 9631. I will answer these in turn. It should be noted that only the 1961-63 period is examined; this is a deliberate choice on my part because of the required brevity of my statement and the fact that earlier periods have been more than adequately analyzed by many economists for the various congressional hearings dealing with monetary matters.

Before turning to an examination of the role that discretionary monetary policy has recently played in counteracting unemployment, let me abide by a Socratic rule and define my terms. I define monetary policy as the use of instrument variables by the central bank, the Federal Reserve System—changes in the size of its portfolio, alteration in the discount rate and the reserve requirement ratio—to influence income, employment, and the price level—the target variables.

The essence of my argument which is set forth in the following section can be very simply stated. In my opinion, recent monetary policy has been dominated by two considerations which, I might add, are not mutually exclusive: (1) the outflow of gold; and (2) an inflation neurosis. I have knowingly used the term neurosis because the so-called inflationary behavior of prices might be more apparent than real; the upward bias in existing price indexes makes it very difficult to be sure that the upward movement of the indexes since 1953 represent genuine inflation. Given this all of the seemingly endless "chatter" by the monetary authorities about the severe inflationary problem actually occurring in the United States, or that which will develop because of the tax cut, strikes me as neurotic. As I attempt to show in what follows, the interaction of these two concerns has caused our monetary authorities to be unwilling to undertake sufficiently the needed expansive monetary actions to achieve a fully employed economy. In other words, I argue that de facto monetary policy is being conducted as if the United States were on a classical gold standard

in which gold flows dominate internal monetary policy. More specifically, the money supply is in effect a dependent variable, determined by external forces.

In this context of subverting internal monetary policy to the needs of external considerations, it should be emphasized that discretionary fiscal policy can be frustrated from attaining its goals. To the extent that the recent tax cut is considered as a device to reduce unemployment and expand output, the manner in which the resulting budgetary deficit is financed is crucial. As is shown later, if the budgetary deficit is financed from the real saving of the community in order to avoid worsening of the U.S. balance-of-payments situation—that is, if there is no increase in the money supply—the Government expenditure multiplier may be zero or even negative.

## II. MONETARY POLICY: 1961-63

### *The money stock and economic activity*

No need here to open Pandora's box and attempt a rigorous and complete evaluation of the role of the quantity of money in determining the economic course of events; but a few observations must be made on this subject as it is relevant to any discussion on the effectiveness of monetary stabilization policies. The existence of an effective transmission from the money stock to economic activity—that is, the successfulness of monetary policy—presupposes a systematic connection between money and aggregate spending. Admittedly, the absence or presence of such a transmission, particularly in a deflationary environment, has been and, in certain quarters, still is subject to considerable disagreement among students of economic affairs. My own view on this question, which is based on my evaluation of the tremendous amount of empirical work done by monetary scholars, is that the supply of money is an important variable in explaining the level of aggregate spending; therefore, it is justifiable to place considerable emphasis on variations in it as a device for control over the levels of income, output, and employment.

Otherwise stated, the empirical evidence shows that there are important uniformities between the levels of aggregate income and output and the money supply; therefore, the parameters of monetary policy which attempt to control the size of the money stock are of utmost importance. The monetary and credit policies of the Federal Reserve have great power to stimulate, stabilize, and depress our economy. It should be noted in passing that I am taking a rather positivistic view here. The empirical evidence gathered shows that monetary changes are very important factors in generating movements in money income. Since I have enough confidence in the persistence of these relationships, I would not hesitate to recommend an increase in, say, the money supply if it is desired to increase money income. This does not mean that I can detail completely the mechanism that links a change in the money supply to economic change; how the influence of a change in the money supply is transmitted to the levels of income and output; what sectors of the economy will be affected first, or what the time pattern of the impacts will be, and so on. Our knowledge of the transmission mechanism is incomplete.

But whether one rejects the above view on the role of money in determining the course of economic activity and argues that changes in

the stock of money matter relatively little in influencing aggregate spending, I think that is agreed by most students of economic affairs that a useful operation of monetary policy is to effectively transmit some policy actions to the parameters which control the size of the money stock. Obviously, the actual policy actions undertaken depend upon the prevailing economic conditions.

Given my view that one of our gravest social ills is the continuation of a less than fully employed economy, and that monetary policy, as subsequently shown, has not been sufficiently expansive in the face of such a situation, a few brief remarks are made in order to justify the view that I am implicitly assuming—that a contributing factor to the present aggregative unemployment rate is a deficiency in effective aggregative monetary demand.

#### *The cause of unemployment*

The levels of average yearly unemployment have been as follows: 1959, 5.5 percent of the civilian labor force; 1960, 5.6 percent; 1961, 6.7 percent; 1962, 5.6 percent; and in 1963, approximately 6 percent. To me, these rates of unemployment are too high.

What is the cause of such unemployment? This is not a simple question. Logically, one could argue that such unemployment rates result from partial-equilibrium problems (nonaggregative ones), wage rates forced above competitive levels by the presence of unions, rigid business prices which, in the face of declining demand, lead to large decreases in output and employment, minimum wage laws, the slowness with which resources move from one location to another in the face of unemployment, and differential rates of technological changes in various industries, to name only a few.

One has to be, it seems to me, very foolish not to recognize the partial validity of the above-mentioned causes of present unemployment. In consequence, part of the current unemployment problem in the economy is not amenable to solving via macroeconomic policy considerations. But even after recognizing this, I adhere to the view that the order of magnitude of the problem can be reduced by increasing aggregate monetary demand through appropriate monetary-fiscal policies. The unemployed in various areas in our economy will not migrate elsewhere unless job opportunities prevail there. It is in this sense that expansionary aggregative measures make one of their most important contributions.

One did not hear the term "structural unemployment" during World War II, since there was a sufficient flow of aggregate spending to employ the then existing labor force. Nor did one hear much talk about "structural unemployment," or "technological unemployment" in 1952, or in 1953, periods in which there occurred a rapid increase in the rate of technological change. Aggregate monetary demand was sufficiently high in these two periods so that unemployment was only 3.1 percent in 1952, and 2.9 percent in 1953, even in the face of rapid technological change.

#### *Gold flows, inflation neurosis, and monetary policy*

An interesting paradox emerges regarding internal monetary policy. Even though gold today serves no function in our domestic monetary system, de facto internal monetary policy is being conducted as if we were on a gold standard, that is, domestic monetary policy is being dominated by gold flows. The extent to which monetary

policy today is influenced by external factors such as gold outflows is an empirical question. To form an empirical judgment on the importance of gold flows in the monetary authorities' utility function is difficult under the most ideal conditions but is compounded by their inflation neurosis as evidenced by the many public statements made by them on the inflationary pressures in the economy. The anti-inflationary bias of monetary policy from January 1953 to January 1961, which was during the Eisenhower administration, is evidenced by the fact that during this complete interval there occurred only a net \$2 billion increase in Federal Reserve credit. Table II also shows this by detailing the behavior of the holdings of Government securities by the Federal Reserve in the 1961-63 period. This worry over internal inflation makes it hard to ascertain where it diminishes relatively and the concern over the balance of payments begins; of course, the important point is that both concerns have influenced monetary policy in the same direction—that is, monetary policy has been less expansionary than it otherwise would have been. Nevertheless, evidence exists from which one can infer that the gold loss problem is becoming increasingly pervasive. First, the public statements by Chairman Martin of the Federal Reserve and the policy directives from the Federal Reserve Open Market Committee have increasingly mentioned the payments deficit as circumscribing the use of vigorous monetary policy to aid in reducing the level of unemployment. The hampering of expansionary monetary policy is described by Mr. Martin in the following terms:

In the circumstances prevailing today, the Federal Reserve has found it necessary to balance domestic and international factors in arriving at policy decisions. The System's responsibility for the value of the dollar extends beyond domestic price stability to the value of the dollar in terms of gold and of other convertible currencies. This is partly a matter of restoring basic equilibrium in the balance of payments, and partly a matter of preserving stability in exchange rates in international markets.

The problems I have been discussing have weighed heavily with those of us in the Federal Reserve in our endeavor over the last year to keep credit conditions attuned to national needs.

On the domestic side, to help bring about recovery, expansion, and sustained growth in production and employment, the Federal Reserve has been operating to bolster the banking systems' ability to *meet all reasonable* borrowing needs. [Italics added.]

On the international side, to help hold down the outflow of capital and gold prompted by the continuing balance-of-payments deficit, the Federal Reserve has been operating to minimize drains stemming from international differentials in interest rates.<sup>1</sup>

Added to this is the reported findings of a recent study by the Federal Reserve Bank of New York that a rise in short-term interest rates could easily reduce the balance-of-payments deficit by \$500 million. Such a belief may have been a factor causing the Federal Reserve to raise, on July 16, 1963, the discount rate from 3 percent to 3½ percent. Under Secretary of the Treasury Robert Roosa cited this then possible forthcoming event before the OEEC meeting on July 10, 1963, as a favorable policy change; he also gave his approval to this monetary policy in testimony before the Joint Economic Committee's hearings on the U.S. balance-of-payments problems. This is interesting, since

<sup>1</sup> Statement of William McChesney Martin, Jr., Chairman, Board of Governors of the Federal Reserve System before the hearings on the January 1962 Economic Report of the President, Joint Economic Committee of the United States, 87th Cong., 2d sess., pp. 174-175.

Mr. Roosa is in the executive branch of the Government; the Treasury and the Federal Reserve System have apparently found agreement on the solution to a problem.

Secondly, the actual behavior of recent monetary policy clearly shows that the interaction of the inflation neurosis and gold flows has inhibited expansionary monetary policy. This observation holds true regardless of whether one views the efficacy of monetary policy in terms of its impact on the power given to the banking system to carry assets or the effect of Federal Reserve action on the money supply. If the latter criterion, which is the fundamental one, is used, the lack of monetary aid given to offset the present underemployment situation becomes obvious. As of December 1961 the money supply was \$145.7 billion (seasonally adjusted); on December 1962 it was \$147.9 billion, a 1.5-percent increase. The level in December 1963 was \$153.5 billion, a 3.8-percent increase. Table I details the monthly behavior in the money supply up to December 1963.

Thus, from December 1960 to December 1963 the money supply increased at an annual average rate of 2.9 percent. This rate of increase is considerably below the historical longrun rate for the economy. I think that this low rate of increase in the money stock is primarily a result of the monetary authorities' concern over the balance-of-payments problem, along with their worry over the presumed presence of internal inflation. As table II indicates, since August 1963 the money supply has been increasing at a much faster rate. This move to a more expansionary policy results, I think, from the freedom given by the rise in short rates in mid-1963, as well as agreements by European countries to help support the dollar through more years of deficit. Also, I suspect that another contributing factor is the acquiescence by European countries in the new policies of domestic expansion undertaken by the U.S. Government. Prof. Harry G. Johnson, in his testimony before this committee, has also argued this same thesis.

From the point of view of Federal Reserve action, what matters, in the first instance, is the amount of Federal Reserve credit (high-powered money) created: This is determined by the size of open market operations. Given the negligible increase in the money supply during the 1961-62 and 1963 periods covered, it is apparent that open-market operations actually conducted were insufficient. Table II shows changes in the portfolio of Government securities of the Federal Reserve System for the period from December 1960 to December 1963.

TABLE I.—*The money supply, 1962-63 (in billions of dollars and seasonally and yearly)*

1962—		1963—Continued	
May.....	145.7	March.....	148.9
June.....	145.6	April.....	149.4
July.....	145.7	May.....	149.4
August.....	145.1	June.....	149.8
September.....	145.3	July.....	150.7
October.....	146.3	August.....	150.5
November.....	146.1	September.....	150.9
December.....	147.9	October.....	152.1
1963—		November.....	153.4
January.....	148.7	December.....	153.5
February.....	148.6		

Source: Federal Reserve Bulletin, June 1963, p. 806.

TABLE II.—Changes in the holdings of Government securities by the Federal Reserve, 1961 to December 1963<sup>1</sup>

[In millions of dollars]	
<i>Period (average of daily figures)</i>	<i>Amount</i>
December 1960 to December 1961	+1,891
December 1961 to April 1962	—46
April 1962 to May 1962	+442
May 1962 to June 1962	+53
June 1962 to July 1962	+30
July 1962 to August 1962	+534
August 1962 to September 1962	—209
September 1962 to October 1962	(+313
October 1962 to November 1962	—714
November 1962 to December 1962	+410
December 1962 to January 1963	—326
January 1963 to February 1963	+207
February 1963 to March 1963	+152
March 1963 to April 1963	+326
April 1963 to May 1963	+208
May 1963 to June 1963	+5
June 1963 to July 1963	+568
July 1963 to August 1963	+57
August 1963 to September 1963	+72
September 1963 to October 1963	+221
October 1963 to November 1963	+472
November 1963 to December 1963	+690

<sup>1</sup> The purchase excludes those bought under repurchase agreements.

Source: Computed from the Federal Reserve Bulletin, May 1963 and February 1964, pp. 650 and 178, respectively.

In the light of the level of unemployment prevailing since 1961, the actual changes in the portfolio of Government securities by the Federal Reserve System seem exceptionally modest. In the absence of a central bank endowed with the powers of a Santa Claus so that needed increases in the money stock can be injected into the system via “chimneys,” the money rain must be implemented primarily through open-market operations. Since high-powered money can be created at zero real social costs, the Federal Reserve System apparently conducted its open-market operations within a constraint imposed by the balance-of-payments situation, or by its fear of inflation, or by both.

Furthermore, it is beside the point to argue that, since excess reserves and/or “free reserves” were “plentiful” during the period as shown in tables III and IV, the bottleneck lies with the commercial banks, not the Federal Reserve. The usual argument offered is that the money supply failed to increase because of the unwillingness of commercial banks to monetize debt rather than the Federal Reserve System’s inadequate increases in high-powered money.

Focusing attention on the statistic “free reserves,” defined as the difference between “excess reserves” of member banks and member bank “borrowings,” it is found that they have been positive since 1960. It is difficult to interpret, however, what this means. As Friedman has pointed out, mathematically—

\* \* \* a given level of pattern of movement of free reserves is consistent with almost any level or pattern of movement of the total money stock. For example, free reserves can remain constant at any specified number, positive or negative, and the money stock increase at a rapid rate or decrease at a rapid rate. It is only necessary that total reserve balances minus member bank borrowing change at the same rate as required reserves.<sup>2</sup>

<sup>2</sup> Milton Friedman and Anna Schwartz, *op. cit.*, ch., 11, p. 60.



Aside from this, and more importantly, assume that there exists an aggregate demand function for free reserves by banks—at any moment of time the banking system demands a certain level of free reserves. In equilibrium, the banks will no longer liquidate assets and/or acquire assets. Assume such an equilibrium level in juxtaposition with free reserves and unemployment. If the Federal Reserve wants to increase the money supply from such an assumed equilibrium level of “free reserves,” it can supply a higher level of “free reserves” than demanded by the banks. An excess supply of “free reserves” exists. Banks will use this excess to increase their loans and investments, thereby increasing the money supply and required reserves; through this mechanism the actual level of “free reserves” is reduced to that desired. If needed, a perpetual disequilibrium situation can be fostered between the desired level of “free reserves” and the actual level. In this process of supplying more high-powered money to the system, the money supply expands; thus, the relevant concept is not the absolute size of free reserves, per se, but this relative to the desired level. The same reasoning applies to the concept of “excess reserves.”

TABLE III.—*Excess reserves for all member banks, 1960-63*

[In millions of dollars]

1960—December.....	756	1963—February.....	472
1961—December.....	563	March.....	426
1962—May.....	503	April.....	434
June.....	491	May.....	457
July.....	529	June.....	377
August.....	566	July.....	480
September.....	455	August.....	467
October.....	484	September.....	413
November.....	592	October.....	408
December.....	572	November.....	415
1963—January.....	483	December.....	525

Source: Federal Reserve Bulletin, June 1963, p. 798, and February 1964, p. 180.

TABLE IV.—*Behavior of “free reserves,” 1960-63*

[In millions of dollars]

1960—December.....	669	1963—February.....	300
1961—December.....	419	March.....	271
1962—May.....	440	April.....	313
June.....	391	May.....	250
July.....	440	June.....	141
August.....	439	July.....	158
September.....	375	August.....	137
October.....	419	September.....	92
November.....	473	October.....	95
December.....	268	November.....	39
1963—January.....	384	December.....	198

Source: Federal Reserve Bulletin, May 1963, p. 652, and February 1964, p. 180.

The foregoing arguments is based on the proposition that the Federal Reserve can effectively control the money supply. Objections are often raised to this view; it is wrong, according to some, to say, except in some irrelevant longrun sense, that the Federal Reserve System controls the money supply or its rate of change—the monetary authorities lack an instrument with a dial pointer marked M or  $\Delta$  M. According to this view, the Federal Reserve can only buy and sell securities in the open market, set reserve requirements, and the discount rate. Less directly, the monetary authorities control the effec-

tive primary reserves of the commercial banks, or at least that fraction which does not arise through the discounting process. Consequently, failure of the money supply to expand sufficiently to counteract unemployment is not even direct evidence showing the possible hampering effects of the international deficit on internal monetary policy. From this viewpoint a measure of effective monetary policy in a deflationary environment is the power given to the banking system to carry assets.

Bypassing any examination of the validity of this view, and using "free reserves" as an indicator of the liquidity—cash—supplied by the monetary authorities to the banks to carry assets, some interesting evidence is found. The use of the statistic "free reserves" is justified, given the apparent importance attached to it by the system in determining its open-market purchases and sales. As shown in table IV, the level of "free reserves" since 1960, with only few exceptions, has been declining. And, in November 1963, the daily average fell to \$39 million. It seems obvious to me that the behavior of monetary policy, either measured in terms of increases in the money supply or by the liquidity supplied to the banks, cannot be considered adequate, given the present unemployment situation.

#### *Monetary policy and the tax cut*

In this context of subverting internal economic policy to the needs of external considerations, it should be emphasized that discretionary fiscal policy can be frustrated from attaining its goals. Chairman Martin, of the Federal Reserve, has stated on several occasions that budgetary deficits resulting from a tax cut should be financed from the real saving of the community in order to avoid worsening the U.S. balance-of-payments situation; that is, the money supply should not be increased. Presumably, the Federal Reserve will pursue appropriate policies so that the deficit is financed from the real saving of the community. To the extent that one is interested in a tax cut as a device to reduce unemployment and expand output, such a monetary policy can be disastrous.

This may be demonstrated by the following: Assume that the amount of unemployment depends on the level of aggregate demand, therefore, amenable to monetary-fiscal policies. Assume, also a simple Keynesian world in which the determinant of total consumer spending is absolute current disposable income, not relative or permanent income; that investment depends on "the" rate of interest, not on current income; Government expenditures are a constant and taxes are a simple linear function of national income. The model, which is in real terms, is drawn in figure 1.

All the elements in this figure are traditional; part A is the Keynesian investment-demand function which includes a constant amount of Government expenditure; part B is the Keynesian demand for money function where the speculative demand for money is subtracted from the total supply money giving the curve  $(M - M_s)$ , the supply of transactions balances; part D is the quantity theory. Part C is the Keynesian saving-investment diagram with the axes reversed and the income scale compressed so that an equal distance on it represents more dollars than the same distance on the horizontal axis; the tax function is incorporated with the savings function. The zero subscripts depict an initial equilibrium situation.

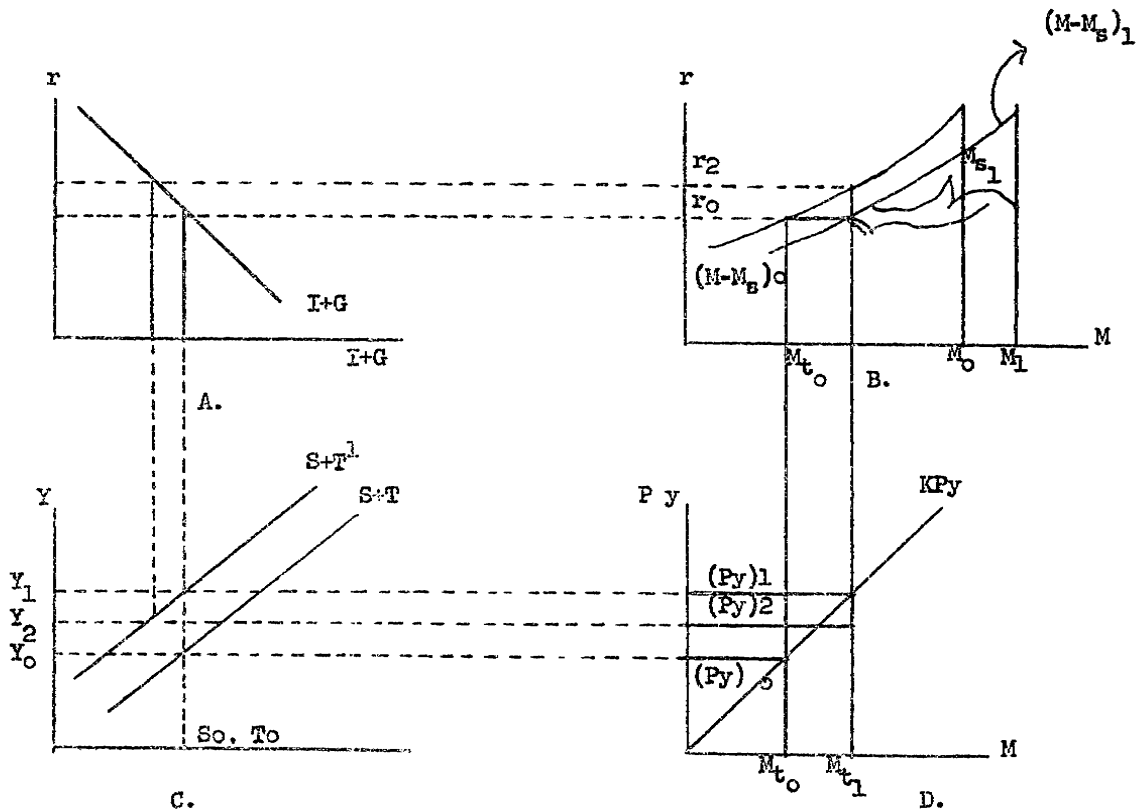

Let there be an identical percentage reduction in the tax rate for all levels of personal income recipients; that is, a downward shift in the tax function so that the consumption function shifts upward or, in our model, a reduction in the savings function. The new saving function is  $(S+T)^1$ . Income goes from  $Y_0$  to  $Y_1$ , via the multiplier. This means an enlarged transactions demand from  $M_{1,0}$  to  $M_{1,1}$ . If the money supply is increased to  $M_1$ , this chain of events can happen as "the" interest rate stays at  $r_0$  so that investment spending does not fall. But assume the money supply remains unchanged at  $M_0$ . Such an income expansion (presumably employment, too) could not occur. Higher interest rates retard the increase in spending resulting from the tax cut. The new equilibrium level lies between  $Y_1$  and  $Y_2$ ; it is less than would be predicted from the multiplier effect alone.

The order of magnitude is, of course, an empirical question. Some indirect evidence on this question is available from Friedman and Meiselman's study.<sup>3</sup> In this study they found that when the money supply is held constant, the partial correlation between autonomous expenditures and consumption, the former defined as net private domestic investment, plus the Government deficit on income and product account, plus the foreign balance, is small for the period under study, 1897-1958. In many comparisons, the relationship was negative.<sup>4</sup> The point is that in any discussion of the expansionary effects of reduced taxes in creating budgetary deficits, it is crucial to specify how the deficits will be financed—whether through the banking system so that the money supply is increased, or through borrowing from the nonbank sector so that the money supply is unchanged. Monetary policy becomes significant in influencing the degree of success of discretionary fiscal policy. To the extent that the monetary authorities in fact do what they say they are going to do; that is, force the Government to finance its deficit from the real savings of the community because of the U.S. external imbalance, the efficacy of alterations in Government expenditures and/or tax receipts in expanding aggregate demand is reduced, if not completely offset.

## II. THE "POLITICAL INDEPENDENCE" OF THE BOARD OF GOVERNORS OF THE FEDERAL RESERVE SYSTEM

The propriety of the "political independence" of the Board of Governors from the executive branch of our Federal Government is a problem of political theory. Consequently, I possess no particular degree of competence which enables me to offer any incisive insights on this question. All I can supply is the view of an individual citizen, who also happens to be an academic economist with a special interest in monetary economics.

As is well known, the seven members of the Board are appointed by the President of the United States " \* \* \* and are appointed for terms of 14 years, with the terms arranged so that one expires every 2 years."<sup>5</sup> The Board's economic powers are of the highest impor-

<sup>3</sup> Milton Friedman and David Meiselman, "The Relative Stability of Monetary Velocity and the Investment Multiplier in the United States, 1897-1958." A staff paper for the report of the Commission on Money and Credit.

<sup>4</sup> *Ibid.*, p. 46.

<sup>5</sup> "The Federal Reserve System, Purpose and Functions" (Washington: Board of Governors of Federal Reserve System, 1954), pp. 76-77.

tance: effective control of the Federal Open Market Committee; effective control of discount rates charged by the various Federal Reserve banks; control of member-bank reserve requirements; “\* \* \* responsibility for the determination of selective regulation of stock market credit”; and, at the various times, the Board has had “responsibility for regulating consumer credit and real estate credit.”<sup>6</sup>

Given the present institutional arrangement, the political, or, if preferred, the ideological, complexion of the Board can be much at variance with any given administration including, of course, the Treasury. To anyone familiar with the history of monetary management in the United States, it is well known that interesting conflicts have arisen between the monetary authorities and the Treasury and even the President of the United States.

In my opinion, the argument for an independent monetary authority is inconsistent with the principles underlying a democracy. To argue that the control over the money supply should be independent of the values of certain representatives of the citizenry in a democracy strikes me as ludicrous. It is as if Congress were to create a Department of War and Peace and the President of the United States would appoint a Board composed of seven members for terms of 14 years, with the terms arranged so that one expires every year. Now this Board would have the exclusive jurisdiction to decide whether or not the United States would or would not go to war. Its decision would be binding irrespective of the wishes of the administration. And, as in the affairs of monetary management, there exists no reason to assume that this Board is so omniscient that the views of the administration are precluded from being considered in making a policy.

What I am saying therefore is that the “political independence” of the Board, often praised as an example of separation of powers, leads to a state of confusion. Congress and the President have in effect executed self-denying ordinances conferring vital powers on their own creatures. Stated differently, when monetary, fiscal, and debt policies are determined by the Executive and Congress with monetary policies determined by the Federal Reserve, the presence of conflict or lack of coordination can cause short-run crises and long-run inefficiencies.

I realize that the above view is completely at variance with the testimony given by Chairman Martin before the hearings on January 21, 1964. In his view, H.R. 9631

\* \* \* raises the issue of whether the Secretary of the Treasury should exercise control over the Federal Reserve System. To oversimplify only slightly, the question is whether the principal officer in charge of paying the Government's bills should be entrusted also with the power to create the money to pay them.

I certainly agree with Chairman Martin when he says later on in his testimony that—

Monetary policy should be directed toward gearing the supply of money and credit to the needs of the economy as a whole, not the needs of the Treasury.

But I see no reason why acceptance of more Treasury representation in the formulation of monetary policy means that the economic health of the Nation will be set aside in order to meet the needs of the Treasury—this implies a “devil” theory of Government finance. Of course,

<sup>6</sup> *Ibid.*, p. 80.

if this were to materialize, the administration can always be voted out by the public. But I see no a priori reason to assume that an independent monetary authority is needed to restrict the Government's natural propensity to resort to inflation.

In all honesty, I do not believe that Chairman Martin holds the above rather extreme position. But I do feel that those who support the argument for an independent monetary authority, at bottom, would probably like to force the legislature and executive branches of our Government to follow conservative economic policies. But fundamentally this decision must lie with the electorate. Consequently, I feel that the Chairman of the Board of Governors should be appointed by each new President and that only men designated by the President should be on the Open Market Committee.

Mr. JOHNSON. Before commenting on these two questions, let me analyze several bills which affect the organizational structure of the Federal Reserve System. I do so now because I failed to discuss them in my prepared statement.

(1) H.R. 9686: This bill provides for payment of interest on U.S. Government deposits and reimbursements of commercial banks for services performed for the United States. I support this bill. My reason for this, which, incidentally, is the same for supporting H.R. 9687, is that I believe that the banking system should be based on competitive principles therefore I oppose arbitrary price fixing in the banking system by the Government. In this case, such price fixing by the Government has been to the disadvantage of the Treasury. It should receive the market rate of interest on its deposits held with banks; by the very same token, the Treasury should pay the banks competitive service charges for handling its deposits.

(2) H.R. 9687: A bill to eliminate the prohibition of interest on demand deposits. I support this bill. My reason for supporting this bill is the same as given in support of H.R. 9686; it restores competition in the banking system, the absence of which has been to the disadvantage of private depositors.

(3) H.R. 9685: The substantive issue in this bill would subject the Federal Reserve system's expenditures to congressional control. This bill aims at a fundamental constitutional change. The Federal Reserve System would have to request appropriations from Congress, which is just the opposite of the present arrangement. Presently, the Federal Reserve System can spend as much as it wants from the profits generated from its credit policies before giving the Treasury the residual.

I must confess that I am unable to set forth an unambiguous view on this bill. On the one hand, I think that the present arrangement cause the System's finances to be embarrassingly easy. In my opinion, such financial ease has led to the sumptuous Board headquarters in Washington, sumptuous individual Reserve banks, and unbelievable financial support for research which, in the main, consists of low-level empiricism; i.e., indiscriminate data gathering, chartmaking, etc. In addition, much of the public-relation activities of the respective Federal Reserve banks are of questionable merit. Alternatively, I could imagine some abuses associated with congressional control of appropriations: underpayment for top civil servants and excessive hounding of the officials in the Federal Reserve, to name only two.

(4) H.R. 3783: A bill to provide for the retirement of Federal Reserve bank stock. I support this bill as I conjecture that it might stimulate a wider spread membership in the Federal Reserve System, to the extent that a 6-percent rate of return is below the present rate of return of bank capital.

Let me now summarize my views on current monetary policy from 1961-63, and then I will turn to the other question regarding the independence of the monetary authorities.

My views on current monetary policy can be very simply stated, sir.

I feel that our monetary policy recently has been dominated by two considerations: One, the outflow of gold, and, two, an inflationary neurosis; these considerations, obviously, are not mutually exclusive.

I have knowingly used the term "neurosis" because in my view the so-called inflationary behavior of prices might be more apparent than real; the upward bias in existing price indexes makes it very difficult to be sure that the upward movement of the indexes since 1953 represents genuine inflation. No need here to get into a technical discussion of index numbers; although I might say the Stigler report to the Government on price statistics is a very important document for those who are interested in seeing how the upward bias is created in price indexes because of failure to make adequate adjustment for improvements in quality and for changes in relative quantities consumed.

But, in my view, what is important is to realize that competent students of index numbers agree that the upward bias in, say, the Consumer Price Index may be large enough to account for almost all of the price rise in the United States from 1953 to 1962. This, policies based upon a desire to combat "inflation" may be wrong policies if in fact there has been no rise in the prices of goods and services when adjustment is made for improvements in quality and for changes in relative quantities consumer.

The point here is that we are, in my opinion, paying a dear price in terms of unemployment and foregone production by not vigorously pursuing expansionary monetary policies because of the fear of rising prices, when the true level of prices has been stable or declining. Given this, all of the seemingly endless "chatter" by the monetary authorities about the severe inflationary problem actually occurring in the United States, or that which will develop because of the tax cut, strikes me as neurotic.

As I attempt to show in my prepared statement, the interaction of the concerns over the gold outflow and inflation has caused our monetary authorities to be unwilling to undertake sufficiently the needed expansive monetary actions to achieve a fully employed economy. As a matter of fact, I am prepared to argue that de facto monetary policy is being conducted as if the United States were on a classical gold standard in which gold flows dominate internal monetary policy. More specifically, the money supply is, in effect, a dependent variable, determined by external forces.

Now, I have some evidence in my prepared statement which, in my view, supports these rather strong statements. Before summarizing this evidence, let me first say a few things on the role of money in determining the economic course of events. I do not attempt a rigorous and complete evaluation of the quantity theory of money, but a few

observations should be made on the role of money in influencing aggregate spending because it is relevant to any discussion on the effectiveness of monetary stabilization policies.

The existence of an effective transmission from the money stock to economic activity—i.e., the successfulness of monetary policy—presupposes a systematic connection between money and aggregate spending. Admittedly, the absence or presence of such a transmission, particularly in a deflationary environment, has been and, in certain quarters, still is subject to considerable disagreement among students of economic affairs. My own view on this question, which is based on my evaluation of the tremendous amount of empirical work done by monetary scholars, is that the supply of money is an important variable in explaining the level of aggregate spending; therefore, it is justifiable to place considerable emphasis on variations in it as a device for control over the levels of income, output, and employment.

Otherwise stated, the empirical evidence shows that there are important uniformities between the levels of aggregate income, employment, and output and the money supply; therefore, the parameters of monetary policy which attempt to control the size of the money stock are of utmost importance. The monetary and credit policies of the Federal Reserve have great power to stimulate, stabilize, and depress our economy. Although, I hasten to add, that I do not want this view to be construed as implying that I adhere to the proposition that monetary policy is the sole method for controlling aggregate economic activity. Even if it were empirically correct that monetary policies were this potent, my values are such that I would not consider it optimal social policy to depend exclusively on monetary policy to maintain a fully employed economy.

But this is neither here nor there insofar as the present discussion is concerned. The empirical evidence gathered shows that monetary changes are very important factors in generating movements in money income. Since I have enough confidence in the persistence of these relationships, I would not hesitate to recommend an increase in, say, the money supply if it is desired to increase money income. Therefore, I think it is justifiable to place considerable emphasis on changes in the money stock as a device to control income, output, and employment.

In consequence, if one views the efficacy of monetary policy in terms of its impact on the money supply, the lack of monetary aid given to offset the present underemployment situation becomes obvious. Table I in my prepared statement details the monthly behavior in the money supply from May 1962 to December 1963. As of December 1961, the money supply was \$145.7 billion (seasonally adjusted); on December 1962, it was \$147.9 billion, a 1.5-percent increase. The level in December 1963 was \$153.5 billion, a 3.8-percent increase.

From December 1960 to December 1963 the money supply increased at an annual average rate of 2.9 percent. This rate of increase is considerably below the historical longrun rate for the economy. I think that this low rate of increase in the money stock is primarily a result of the monetary authorities' concern over the balance-of-payments problem, along with their worry over the presumed presence of internal inflation. Admittedly, as table I indicates, since August 1963 the money supply has been increasing at a much faster rate. This move to a more expansionary policy results, I think, from the freedom given



by the rise in short rates in mid-1963, as well as agreements by European countries to help support the dollar through more years of deficit. Also, I suspect that another contributing factor is the acquiescence by European countries in the new policies of domestic expansion undertaken by the U.S. Government. As a matter of fact, Prof. Harry Johnson, of the University of Chicago, in testimony before this committee also gave these reasons for the explanation of the recent move to monetary ease. However, whether such monetary ease will continue is problematical, given the recent statements by the monetary authorities on the possible inflationary effects and payments effects of the recent tax cut.

The foregoing argument is based on the proposition that the Federal Reserve can effectively control the money supply. Objections are often raised to this view; it is wrong, according to some, to say, except in some irrelevant longrun sense, that the Federal Reserve System controls the money supply or its rate of change. According to this view, the Federal Reserve can only buy and sell securities in the open market, set reserve requirements, and the discount rate. Less directly, the monetary authorities control the effective primary reserves of the commercial banks, or at least that fraction which does not arise through the discounting process. Consequently, failure of the money supply to expand sufficiently to counteract unemployment is not sufficient evidence showing the possible hampering effects of the international deficit and/or worry over internal inflation on internal monetary policy. From this viewpoint, a measure of effective monetary policy in a deflationary environment is the power given to the banking system to carry assets.

Bypassing any examination of the validity of this view, let me call your attention to the behavior of two factors which are often used as indicators of the liquidity (cash) supplied by the monetary authorities to the banks to carry assets. These factors are (1) the amount of Federal Reserve credit (high-powered money) created, which is determined by the size of open market operations; and (2) the statistic "free reserves," defined as the difference between excess reserves of member banks and member bank borrowings.

Turning first to the statistic Federal Reserve credit: Given the negligible increase in the money supply during the 1961-62 and 1963 periods covered, it is apparent that open market operations actually conducted were insufficient. Table II in my prepared statement shows changes in the portfolio of Government securities of the Federal Reserve System for the December 1960-December 1963 period. In the light of the level of unemployment prevailing since 1961, the actual changes in the portfolio of Government securities by the Federal Reserve System seem exceptionally modest. In the absence of a central bank endowed with the powers of a Santa Claus so that needed increases in the money stock can be injected into the system via "chimeys," the money rain must be implemented primarily through open market operations.

The anti-inflationary bias of monetary policy is not peculiar to the 1961-63 period. From January 1953-January 1961, which was during the Eisenhower administration, there occurred only a net \$2 billion increase in Federal Reserve credit.

Turning now to the behavior of the statistic "free reserves": Table IV in my prepared statement shows that the level of "free reserves" since 1960, with only few exceptions, has been declining. And, in November 1963 the daily average fell to \$39 million. It seems obvious to me that the behavior of monetary policy, either measured in terms of increases in the money supply or by the liquidity supplied to the banks, cannot be considered adequate, given the present unemployment situation.

Of course, I do not mean to imply that the present unemployment situation can be completely solved via macroeconomic policies. As I am careful to point out in my prepared paper, part of the current unemployment problem in the economy is not amenable to solving via macroeconomic policy considerations. Part of the observed present and past rates of unemployment results from partial-equilibrium problems (nonaggregative ones). But even after recognizing this, I adhere to the view that the order of magnitude of the problem can be reduced by increasing aggregate monetary demand through appropriate monetary-fiscal policies. The unemployed in various areas in our economy will not migrate elsewhere unless job opportunities prevail there.

Let me now turn to examine the other question that I have been asked to comment on. That is to say, the propriety of the "political independence" of the Board of Governors from the executive branch of the Federal Government.

This question is, of course, a problem in political theory. Consequently I possess no particular degree of competence which enables me to offer any incisive insights on this question. All I can offer is the view of an individual citizen, who also happens to be an academic economist with some special interest in monetary economics.

All of you know that the seven members of the Board are appointed by the President of the United States, and that under the present institutional arrangement the political, or, if you prefer, the ideological, complexion of the Board can be much at variance with any administration including, of course, the Treasury. To anyone familiar with the history of monetary affairs in the United States, it is well known that conflicts have arisen between the administration and the monetary authorities, and even the Treasury and the President of the United States.

Now, in my opinion the argument for an independent monetary authority is inconsistent with the principles underlying our democracy.

To argue that control over the money supply should be independent of the values of certain elected representatives of the citizenry in a democracy strikes me as ludicrous. It is as if Congress has created a Department of War and Peace, and the President of the United States would appoint a Board, composed of seven members for terms of 14 years, with the terms arranged so that one expire every year. Now this Board would have the exclusive jurisdiction to decide whether the United States would or would not go to war. The Board's decisions would be binding, irrespective of the wishes of the administration. But, as in the affairs of monetary management, there exists no reason to assume that this Board is so omniscient that the views of the administration should be precluded from any decision.

What I am saying therefore is that the "political independence" of the Board, often praised as an example of separation of powers, leads to a state of confusion. Congress and the President have in effect executed self-denying ordinances conferring vital powers on their own creatures. Stated differently, when fiscal and debt policies are determined by the Executive and Congress with monetary policies determined by the Federal Reserve, the presence of conflict or lack of coordination can cause short-run crises and long-run inefficiencies.

Interestingly enough, the present situation surrounding the tax cut shows how such confusion and conflicting policy pronouncements can develop under the present independence of the Board. Chairman Martin has stated on several occasions that budgetary deficits resulting from a tax cut should be financed from the real saving of the community in order to avoid worsening the U.S. balance-of-payments situation; that is, the money supply should not be increased. Presumably, the Federal Reserve will pursue appropriate policies so that the deficit is financed from the real saving of the community. As I show in my prepared statement, to the extent that one is interested in a tax cut as a device to reduce unemployment and expand output, such a monetary policy can be disastrous.

I realize that my view on the relationship of the Board to the administration is completely at variance with the testimony given by Chairman Martin before the hearings on January 21, 1964. In his view, H.R. 9631—

Raises the issue of whether the Secretary of the Treasury should exercise control over the Federal Reserve System. To oversimplify only slightly, the question is whether the principal officer in charge of paying the Government's bills should be entrusted also with the power to create the money to pay them.

I certainly agree with Chairman Martin when he says later on in his testimony that—

Monetary policy should be directed toward gearing the supply of money and credit to the needs of the economy as a whole, not the needs of the Treasury.

But I see no reason why acceptance of more Treasury representation in the formulation of monetary policy means that the economic health of the Nation will be set aside in order to meet the needs of the Treasury—this implies a "devil" theory of Government finance. Of course, if this were to materialize, the administration can always be voted out by the public. But I see no a priori reason to assume that an independent monetary authority is needed to restrict the Government's natural propensity to resort to inflation.

In all honesty, I do not believe that Chairman Martin holds the above rather extreme position. But I do feel that those who support the argument for an independent monetary authority, at bottom, would probably like to force the legislature and executive branches of our Government to follow conservative economic policies. But fundamentally this decision must lie with the electorate. Consequently, I feel that the Chairman of the Board of Governors should be appointed by each new President and that members of the Open Market Committee should be designated by the President. Thank you.

The CHAIRMAN. Thank you, sir. Prof. Robert Strotz, of Northwestern University is next.

Professor, we took the liberty of starting early this morning, since Professor Johnson was here, in view of the fact that the House is meeting at 11 o'clock instead of 12, as it normally meets.

You have a prepared statement I believe. You may place it in the record at this point and summarize it like Dr. Johnson did, if you desire, or you may put it all in and read it, if you want that. It is entirely up to you.

You may proceed in your own way, sir.

**STATEMENT OF ROBERT H. STROTZ, PROFESSOR, DEPARTMENT OF ECONOMICS, NORTHWESTERN UNIVERSITY**

Mr. STROTZ. Thank you very much, sir.

I want to say, first, that I very much appreciate the opportunity to present my views before your committee on the bills that are under consideration. I think what I shall do is to follow my prepared statement.

The CHAIRMAN. All right, sir.

Mr. STROTZ. Democratic values, in my opinion, place a burden of proof upon those who advocate an independent central bank. By an independent central bank we mean, of course, one whose authority is substantially independent of the executive wing of the Federal Government. At present, apart from the moral suasion that the Executive can exercise on the Board of Governors of the Federal Reserve System, the President's direct power is the power of appointment. Appointments, however, are not at the pleasure of the President. Under present arrangements, the Board of Governors is almost like the Supreme Court in the continuity of its majority. A majority membership of the Board can persist for at least two terms of office of a given President. Are there reasons why the Board of Governors should enjoy this relative autonomy from direct Executive control? My view is that there are some definite reasons for it, though I shall argue subsequently that there are even more compelling reasons against it.

The maintenance of the relative stability of the dollar as a measuring rod of economic value is an important requisite for the orderly conduct of personal and business transactions in a modern society. That the obligation of government to maintain reasonable price stability has often been ignored by those in power is commonplace historically, and is widespread geographically even at the present time. When the executive and legislative authorities pay little heed to the maintenance of an essential condition for the satisfactory functioning of the social and economic system, there are grounds for making it at least difficult for them to exercise control in that area. The very concept of a constitution, and an independent supreme court to interpret it, reflects this view. The fundamental law of the land may be changed, but only with difficulty and by a process that requires more time than needed for the change of statutory legislation. Since monetary stability is also a fundamental matter, there is a case for making departures from stability slow and difficult to achieve. For that reason, we have desired historically to remove monetary policy from the quick control of the Federal Executive. Though the policy lines of the Board of Governors can be changed through the political process,

just as can the composition of the Supreme Court, it takes a good deal more time than required to change the policies of other executive agencies. This hopefully introduces an element of stability in monetary policy that is somewhat greater than the stability of parties or persons in the Executive Office.

Indeed, advocates of the gold standard argue that by tying the quantity of money and credit to the rather slowly changing stock of gold, the value of the dollar is likewise protected from the vagaries and instabilities of political control. The gold standard and the independent central bank are both devices for trying to make reasonable price level stability as permanent as the Bill of Rights.

Concerned with this same problem, there are others who, eschewing both the gold standard and an independent central bank, would bring the central bank under direct Executive control but would impose a statutory constraint restricting the scope for discretionary policy on the part of the central bank authorities. They would require, for example, that the Federal Reserve System's operations be calculated to assure some prescribed annual rate of growth in the supply of money. This, too, is a device for wresting monetary policy from the quick discretionary control of the Executive power.

Let me consider the gold standard first in this connection. The difficulty with it is that it does not work as it was once thought it would. It does not make possible the harmonious achievement of a balance among economic objectives, such as the stabilization of the foreign exchange rate, domestic price stability, full employment, and economic growth. Though it should automatically lead to the stability of international exchange rates, it may even fail in that purpose. This is because the gold standard may be put aside as soon as the balance-of-payments adjustments that it dictates become too harsh for a nation to bear in view of its other policy objectives. Nor, even within the context of an isolated economy, would the gold standard in fact stabilize the value of money or even its quantity. This is because there are too many other forces and policy instruments that can affect the quantity of money even though the gold content of the dollar is fixed. A consequence then is that it may do more harm than good. For example, if a nation is determined to maintain full employment, especially in the face of inflationary pressures on wages and prices, adherence to the gold standard only presents the nation with severe problems relating to its international trade position. When several instruments of monetary policy are available, they should be used in concert. It is a mistake under such circumstances to freeze one policy dial in a fixed position while others can still be twiddled. We thereby lose a degree of freedom in our choice of policies, guarantee the stability of practically nothing, and reduce the fineness with which we can strike a balance among various policy objectives.

With an independent monetary authority the problem is much the same. The policy instruments available to the central bank are pertinent to: (1) the determination of the level of prices; (2) our foreign exchange position; (3) the level of employment; and (4) the rate of economic growth. Indeed, we might add to this (5) the availability of capital funds to different classes of borrowers, short term and long term, big and small. The Federal Reserve System has but one set of policy instruments at its control and a set of diverse, and often con-

flicting, target variables to influence. But, unhappily for the Board of Governors, their authority is not complete—and many doubt whether it is even primary—in influencing these targets. Decisions as to Federal expenditures, decisions as to Federal tax receipts and their distribution, as well as Treasury debt policy, all play important roles—to say nothing of the influence of Government in affecting price and wage policies more directly. Thus, from every limb of the puppet go many strings held by different authorities, all of whom may have different intentions as to how the puppet is actually to perform—and in the midst of a windstorm. In such a situation, who can dispute the need for coordination of the many different “puppeteers”? The notion of an independent monetary authority set up to achieve a particular goal, such as price level stability, is, in any practical context, very unrealistic.

I do not feel the matter is simply a problem of getting the Board of Governors and the Open Market Committee to perform well. The problem is largely in deciding what “well” is and in recognizing that any agreement can change over time with shifts in public, congressional, and Presidential opinion. It can also change as a result of changes in underlying economic conditions which may be unforeseen and uncontrolled.

These objections can also be advanced in connection with the notion that the central bank should be put under statutory requirement to perform in a particular way, according to some prescribed formula. This also removes monetary policy from the discretionary control of the Executive. These are two main objections:

(1) One objection has to do with whether or not regulation of either “the” interest rate of the “quantity of money” is sufficiently important that it can overrule the effects of the fiscal and debt policy of the Federal Treasury. I am inclined to the view that stabilization of the rate of growth of the quantity of money has much to recommend it, that the quantity of money is in fact a pivotal variable in monetary policy. In principle, variations in the velocity of circulation of money may offset or completely contramand directional changes in the quantity of money, but I think that the velocity of circulation becomes an “autonomous” variable of importance only when the quantity of money is either rising or falling at so rapid a rate as to set up the expectations that controls are being lost. Nevertheless, the evidence is far from conclusive and the velocity of circulation is surely not impervious to wide changes in the liquidity or tax positions of decision-makers within our economy. Though I would regard a policy of holding the rate of growth of the money supply at some prescribed level as desirable as a longrun objective, I do not feel sufficiently confident that there would not occur from time to time good reason to depart from it, and so I should not want us to tie our hands completely to such a policy.

(2) A second objection to the imposition of a policy rule on the Federal Reserve System is that there is not enough agreement as to what that rule should be. Even if it were agreed that it should be expressed in terms of a fixed rate of growth in the money supply, there would still be dispute about what that rate should be. Opinions here rest upon views as to the relative importance of inflation, unemployment, and insufficiency of economic growth. These are matters on

which we do not have wide consensus in our society, and it ought to be possible for us to change our judgment of their relative importance at least as often as we elect new Congresses. All this becomes clearer, I think, when we recognize that the distinction between rules and authority in monetary policy is more a figure of speech than a logical distinction. Behind all rules there are authorities, and authorities can change the rules, whatever they may be. The choice then is primarily one of the procedures by which rules and policies can be altered. If the rules are written into the Constitution, they can be changed only very slowly; if they are subject to the direct control of the President, they can be changed whenever he chooses to change them. My feeling is that when the desired rules are still in dispute and their effects are not yet clearly understood, it is too early to chisel them into the marble facade of the Federal Reserve Building. Indeed, I object to the independence of the Federal Reserve System from more direct executive control precisely for these reasons.

As for present Federal Reserve policy, I would voice the following complaints. I am disturbed to find the Board of Governors already so concerned about the possible inflationary effects of the recent tax cut as to consider moving in a direction that nullifies the intended expansionary effects on employment motivating the cut in the first place. In addition, I feel that the Federal Reserve System ought to pay less attention to very short-term fluctuations and should adhere more steadfastly to longer run intentions. In particular, I feel that the Federal Reserve System "mothers" the market for Treasury debt much too much; I believe that market can survive on its own if only longrun monetary policy is well defined and adhered to.

I also feel that it is a mistake to regard "the" interest rate rather than the quantity of money as the primary gage for monetary policy. I think there should be some freedom for interest rates to be flexible, just as the price of steel and wage rates should be flexible. I believe this because interest rates are essentially price ratios relating the command of goods in the present to the command of goods in the future. The quantity of money serves more neutrally as the primary control of the level of prices and of economic activity.

To summarize, there are two central objections that I have advanced against the relative autonomy of the Federal Reserve System. One, there is not enough agreement about what constitutes a proper rule of central bank policy to warrant the removal of the central bank from the immediate direct control of the Executive. Secondly, even if there were such an agreed upon policy, its success would require that it be coordinated with fiscal and debt policy that must reside in the Treasury. Therefore bank policy should not be determined independently.

House bill 9631 meets these objections by bringing the Board of Governors directly under the control of the President and authorizing the President to remove any appointed member from office at his pleasure. Federal Reserve bank policy would therefore be more responsive to the will of our elected officials and could thereby be better coordinated with fiscal and other instruments of policy for achieving diverse national economic objectives. Thank you.

The CHAIRMAN. Thank you, sir. Mr. Reuss?

Mr. REUSS. Thank you, Mr. Chairman.

Professor Johnson and Professor Strotz thank you both very much for your important contributions to our study.

Both of you gentlemen expressed some alarm—and I was glad you did so—that the Federal Reserve System has justified its failure to provide adequate increases in the money supply on two grounds—the need to combat a nonexistent demand inflation at home; and, secondly, for so-called balance-of-payments considerations. In the second case, I take it you meant the argument that interest rates in the United States, if too low relative to foreign interest rates, would encourage capital outflow from the United States.

Mr. JOHNSON. Or, more specifically, sir, the gold outflow which they mention, which would be a result of this, presumably.

Mr. REUSS. Yes; the gold outflow is a second step.

Mr. JOHNSON. Right.

Mr. REUSS. I agree with you gentlemen on both points.

However, in fact, I think that recent statements of the Federal Reserve on the need to restrict credit and money supply are even more bloodcurdling than the ones you named.

For example, Chairman Martin has recently brought forward two additional reasons for tightening money. I wonder if you are familiar with them and would like to comment on them.

Additional reason No. 1 is that he fears that the quality of credit in this country is deteriorating. This is really a different point from the demand inflation point, in that you could have no demand inflation, but still have the ghost of credit deterioration under the bed.

I would like your comment on this point.

A further point made by Chairman Martin, quite recently before this committee, has to do with our international economic problems. But it is a somewhat different point from the ordinary one of let's keep our interest rates high here so money doesn't go abroad.

Chairman Martin said that in order to cure our balance-of-payments difficulties, we must export more. If I may be parenthetical here, everybody would agree with this portion of his contention. But it turns out that his way of exporting more is to get prices down at home by squeezing the money supply.

To me, this is an outrageous proposition. I have wondered why the economics profession of the United States hasn't cried from the housetops about how self-defeating a policy that is.

I would like the views of both of you gentlemen on both of those propositions, insofar as you care to express them.

Mr. STROTZ. If I may comment first, I have been aware of the first additional point you mention, the concern expressed that under the expansionary forces that we should expect to result from the recent tax cut, there may be irresponsible borrowing on the part of consumers. If this is indeed Mr. Martin's point I am a bit astonished that he has displayed so little confidence in the banking community. My feeling is that the problem of judging credit quality is a problem for the commercial bankers and others who run lending institutions. In the past they have been in serious difficulty only when the Federal Reserve System has permitted the quantity of money to fall drastically, thereby producing a situation very unlike anything that would constitute a proper environment for the determination of terms of credit.



The fourth point is closely related to the second, and this is what I meant in making reference to our foreign trade position. There are two concerns here, of course. One is that if interest rates in the United States are too low, there will be an outflow of capital; the other is that if our price level is not low enough, we may not export so much as we ought to.

I can give you here, sir, only an impression that I hold. I know that this is a complicated topic. My feeling is that over recent years the Federal Government, and the Federal Reserve System, of course, have been much too concerned about our foreign balance problem. It is, of course, a serious problem. It would be a much lesser problem if we had freely fluctuating foreign exchange rates. But I am disturbed that concern over this problem has dominated, as I see it, the discussion and consideration given to problems of maintaining a higher level of employment than we have maintained for some time.

Mr. REUSS. Thank you.

Before asking Professor Johnson for his comment on these two points, I would like to share an observation with you. I think one can make an argument for keeping short-term interest rates higher than they would otherwise be, for balance-of-payments reasons, since small increases in short-term interest rates don't necessarily bring about recession or unemployment at home. Therefore, it may be a worthwhile price to pay for international payments stability, by keeping short-term capital from moving from the United States abroad.

However, when you talk about solving our balance-of-payments difficulties by getting export prices down via monetary policy, you are really advocating a most radical and distressing thing. If this statement means anything, it means that the author of this statement is in favor of bringing on something approaching a depression in this country by monetary policy which could through bankruptcy and unemployment and stress generally, effectively reduce prices.

Before turning to Professor Johnson, I would like to ask Professor Strotz whether this additional argument recently thrown on the table by the Federal Reserve isn't actually a much more alarming argument than some of their earlier ones.

Mr. STROTZ. Well, I doubt certainly that the Federal Reserve authorities would want to produce a recession. But I agree entirely with the logic of your analysis.

Mr. REUSS. How do they through monetary policy get prices down other than by bringing on a recession?

Mr. STROTZ. At least we can say that reducing prices is not something we want to do at a time when employment is less than we want it to be. Price reduction at this point would simply go counter to what we are attempting to achieve through the tax cut. I quite agree that this concern is highly unfortunate, and certainly in spirit I think I can say that I agree with all that you have said.

Mr. REUSS. Thank you. Professor Johnson?

Mr. JOHNSON. Yes, sir. Let me comment on your questions.

I agree with my colleague, Professor Strotz, on the third question. I think the quality of credit, whatever that may mean, should be handled by the commercial banks. In other words that is their worry.

I am also a believer in free enterprise, therefore, I feel that individuals are the best judges of their own economic position, which includes, obviously, borrowing. So, therefore, I feel that the concern over the quality of credit is not a substantive issue.

Commercial banks should be able to ascertain whether the risk is good or bad. Hence, I do not share Chairman Martin's concern on this problem.

On the fourth question you raise: I also share completely, as Professor Strotz does, the logic and the spirit of your observations.

I feel that the statement by Chairman Martin is in principle a very dangerous one. Once again it indicates the subverting of internal goals for external considerations. I feel that monetary policy has been overly concerned about our foreign trade account, and, therefore, it has been less expansionary than it should have been, given the rate of unemployment we have experienced in the last several years.

You are quite correct, Congressman Reuss. It is a very interesting observation made by Chairman Martin.

England in 1925 went back on the gold standard and overvalued the pound sterling. And in order to bring its internal prices in line, of course, the monetary authorities had to do what you suggested. In other words, to embark on a deflationary monetary policy, with disastrous results.

My personal view, sir, is that one of the problems we face is that the dollar is overvalued, and we will continue to have a balance-of-payments problem as long as the United States continues to maintain convertibility of the dollar into gold at a fixed price for foreign central banks. This arrangement presents a real problem to us.

However, I feel that monetary policy even with these external problems, should be expansionary because of the unemployment situation in the United States. And that if Chairman Martin does what he says he is going to do this could be, as you say, very disastrous. It would worsen our unemployment situation in the United States.

Also, one thing Professor Strotz mentioned, which should be mentioned again because it is very crucial, is in regard for this tax cut. It is very vital the way the budgetary deficit is financed. If the deficit is financed from the real savings of the community, that is, finance the deficit by selling bonds to the nonbank sector in the community so that there is no increase in the money supply, this can nullify the presumed expansionary effects of the tax cut.

So I share your concern about subverting the internal goal of full employment to maintain external balance, or presumably, to arrest the loss of gold.

Mr. REUSS. On the third point; namely, on the quality of credit being strained, to do Chairman Martin justice—although he probably would not accept me as his champion—he refers not only to consumer credit but to all kinds of credit. To put his case for him, he is concerned about stock market credit.

I would answer that, of course, by saying that if he did his job and applied regulations T and U, relating to stock market credit, bankers' as well as brokers' loans, he could insulate off the stock market from credit which is necessary for the rest of the economy to keep going. Would you agree with that?

Mr. STROTZ. I would agree that that would be an effective instrument, provided, of course, that one wants to give the stock market special treatment. I am not sure that I would be so concerned as some people if the availability of greater amounts of bank money were to lead to some rise in stock prices. This is a reduction effectively in the rate of interest, and is the sort of thing that one wishes to achieve if one wants to stimulate investment in the economy. And that is something one wants to do, if one wants to reduce unemployment.

Mr. REUSS. Come again on that? Were you saying increases in equity prices reduce interest rates?

Mr. STROTZ. Yes.

Mr. REUSS. This hasn't happened in the last 3 years.

Equity prices have gone up, and so have interest rates. It could have been the other way around. But, in fact, they have moved upward.

Mr. STROTZ. I should have made myself clearer. By interest rate here I refer to something more general than what we typically call an interest payment. If firms are able to raise funds on more attractive terms; that is, if the price to dividend ratio is increased, this in effect means that they can acquire money at lower cost than otherwise. Now, this is, of course, equity rather than bond financing. I was misleading in referring to a rise in the price of stocks as a decline in the interest rate. But stock prices can function much as an interest rate functions. And anything that would reduce interest rates or the terms on which equity capital can be raised should stimulate corporate investment.

Mr. REUSS. I wish we had more time to explore this, because I have some difficulty with what you are saying.

It seems to me that equity investors are more likely to buy stock, when stocks are yielding a high rate of return, let's say 6 percent, rather than a low rate of return, let's say, 2 percent. The higher the level of stock market prices, the less attractive it would be for investors.

However, we are getting off the subject, and I would conclude, since my time is up, by thanking both of you for your observations. I was principally concerned to ask your opinion on the Federal Reserve's worries about credit deterioration as a reason for tightening money, and its express desire to bring about a lowering of prices at the present time by monetary policy. I believe you gentleman have rejected these and earlier arguments of the Fed for a more restrictive monetary policy.

The CHAIRMAN. Mr. Brock?

Mr. BROCK. Thank you, Mr. Chairman.

Do I understand both of you feel that in essence—or the impression I have from your statements is that you feel that the present adherence to a modified gold standard is not a practical thing in this day and time. Is that correct?

Mr. JOHNSON. Yes, sir. I feel it is somewhat a paradox that recent monetary policy, in my view, has been conducted as if we were on a classical gold standard. It is a paradox because gold serves no function in our domestic monetary system.

Prof. Harry Johnson, of the University of Chicago, made a classic statement in one of his publications on this subject. He said that if

one wants to put the present policy choices in capsule form it is gold versus jobs.

Therefore, his view, and I share this view, is that a choice has been made to give up obtaining full employment in order to keep the gold stock of the United States. So to this extent I feel that monetary policy has been dominated by concern over gold.

Mr. BROCK. Well, the law as it is presently written, requires that we do have a 25-percent reserve, which amounts to \$12 billion at the present time. Given the rather thin line we have above that with our present gold stock, I think you would perhaps reflect the same concern if you were in the position that they were in, would you not, unless the law were changed?

Mr. JOHNSON. Well, I would do two things, sir, if I were in the position of being a "dictator." I would surely hope that we are sophisticated enough today in our monetary policy to realize that gold has very little to do with anything from the point of view of determining the value of money. So one thing I would do is to request Congress for the elimination of this gold coverage provision.

Mr. BROCK. To clarify, as I recall we had Dr. Heller several months ago, and he suggested if we got into a greater crisis than we are presently in, that perhaps the next step might be to withdraw the 25-percent gold requirement, so as to free this \$12 billion for international payments.

You would suggest going even further and removing gold as a standard in any case, would you?

Mr. JOHNSON. Yes, sir.

The second thing I would do if I could play "dictator" would pursue monetary policy independent of any gold consideration. In other words, let the gold flow out; we give up a worthless commodity for real goods and services. To me, that is a good swap.

The more fundamental problem, sir, in causing the gold loss is because of a disequilibrium in the balance of payments. This results because the dollar is overvalued. So long as this is true and as long as we are willing to convert foreign balances into gold for foreign central banks, internal monetary policy will be dictated by foreign central bankers.

Mr. BROCK. As the law is presently written, that is the way it has to be.

Mr. JOHNSON. Yes, sir. But it would seem to me that one should carefully consider the whole international monetary mechanism with its frozen exchange rates; but even if one wants to ignore this, I would worry about the problem of unemployment and let the gold leave the United States.

Mr. BROCK. I agree. The point is I am not sure we can be excessively critical of monetary authorities when they simply have these standards to which they have to adhere.

They cannot change the law.

Mr. JOHNSON. Yes, they work with this framework. You are quite right, sir. The argument is that when governments are committed to a fixed exchange rate system, domestic monetary policy must be subordinated to external consideration. I suppose I am more extreme on this position than others. What I really am saying is that, given the commitment to a fixed exchange rate, the Federal Reserve should

still pursue domestic expansionary policies, let the gold flow out, and therefor force a facing of the issues squarely. This would, I hope, result in an abolishment of the gold law.

Mr. BROCK. Of course the Congress has to do this.

Mr. JOHNSON. That Congress would consider the abolishment of the gold coverage provision; yes, sir.

Mr. BROCK. I think one of the gentlemen mentioned one of their dials is frozen according to law. I was interested—Professor Strotz, you mentioned the quality of credit. As a matter of fact, both of you said that this is something we should leave up to the banks in a free enterprise economy.

It is true, of course, that the Federal Government has to insure these deposits through the FDIC, and it seems to me only logical that we should concern ourselves within certain limits with the quality of credit in this country. I don't think we can leave it entirely up to the banks. Do you really feel we should?

Mr. STROTZ. I certainly think, sir, that the FDIC has a proper responsibility for concerning itself with the danger of unacceptable lending habits on the part of any particular bank. But my view is that the FDIC, in fact, provides very little insurance against a complete collapse in our economy, our monetary system.

Mr. BROCK. Actually, it is more of a psychological thing, is it not?

Mr. STROTZ. Yes, I think so, indeed. And I am referring here not to bad bank practice on the part of some particular bank. There will be isolated instances of this from time to time. But I am referring to the general conditions of credit, and I think that for the most part our commercial bankers do a reasonably good job in deciding who are and who are not good credit risks.

Mr. BROCK. Too good a job sometimes when you and I want money, perhaps. I would agree.

Professor Johnson, in your statement I noticed a sentence on page 10 in which you say: "However, money can be created at zero real social cost." That is an interesting thought.

I am not trying to throw the bugaboo of inflation at you, which you don't seem to be too concerned about, but inflation, if it is excessive, does have some social costs, does it not?

Mr. JOHNSON. Yes, sir. There is no question about this.

Let me be clear in my view on this, sir. I didn't mean to imply that one should be impervious to the problem of inflation. I share Professor Strotz concern that price level stability is a goal which we all should be concerned about.

My feeling is, sir, that, as I look at the record, the worry about inflation since 1953 has been overaggrated. One uses the Consumers Price Index, which I might add is a very fine price index, as a rough measuring rod for measuring changes in the general level of prices.

Now, if one examines the behavior of the Consumers' Price Index, especially since 1953, or after the first 6 months of the Korean war, I think you will see a general upward drift in this index.

Now, my statistician friends tell me that a significant part, if not all, of this rise in the CPI can be explained by the upward bias which is structured in this price index. As I mentioned earlier, this results from certain technical characteristics in the construction of price indexes—the constant repricing of a frozen basket of goods as well

as the inability to measure the quality improvements in the goods and services which makeup the index, what this mean is that the past inflationary problem in the United States has been greatly over-exaggerated. In fact, I don't think we have had that much, or if any inflation, since 1953. This leads me to conclude that we have been paying a very dear price in terms of foregone production and unemployment to fight a nonexistent inflation.

The other point on zero real cost—we haven't a Santa Claus bank where we can put money down chimneys, or are we allowed to put money in airplanes and drop it out in the economy. What we have is a monopoly bank, namely, the Federal Reserve System.

Now, when the Federal Reserve creates money, member bank reserve or, if desired, paper money, it can do so at negligible or zero real costs—that is, the resource costs of printing money or creating demand deposits by the central bank is negligible, possibly zero. That is what I meant by this statement, sir.

Mr. BROCK. I am sorry. I thought social costs—you were talking about the costs to the people.

Mr. JOHNSON. No, I didn't mean it that way, sir.

Mr. BROCK. In terms of purchasing power.

Professor Strotz mentioned that he felt like interest rates should be free to fluctuate according to the supply and demand of money.

I assume that you would agree with this, Professor Johnson—that you should have a free interest rate, that it should find its own level. Or do you think we should put a ceiling on interest rates?

Mr. JOHNSON. My answer, sir, would be that if you control the money supply properly, I would not be particularly worried about interest rates. But I agree with Professor Strotz, yes, that interest rates should move freely in the market, with the proviso, and I think Professor Strotz would agree, that if you have a proper control of the money stock a proper structure of interest rates results.

Mr. BROCK. We have one bill which would provide that there be a ceiling on the yield of Government securities, 4½ percent. You would not endorse this, then, as I understand it.

Mr. JOHNSON. Well, as I said, my view—

Mr. BROCK. A fixed statutory limit.

Mr. JOHNSON. No, I would not support this; I do not believe that you should put a ceiling on the interest payments to be made by the Government. I feel this is not really a real substantive issue, to the extent that the money supply is regulated properly one doesn't have to worry too much.

Mr. BROCK. What concerns me is that we seem to be putting the cart before the horse. Some suggest that we fix interest rates in order to lower the cost of money to people. In my view, at least—and maybe I am not a classical economist—but this might have a real cost in terms of purchasing power which would be far more destructive than the savings you could achieve by reducing the cost of borrowing—if you had a fixed limit on interest.

Mr. STROTZ. May I comment on this, Congressman?

Mr. BROCK. Surely.

Mr. STROTZ. I am in basic agreement with what you have just said. There are two ways in which we can look at this. We can think of ourselves as regulating the quantity of money. Then the interest rate

will be determined by the technical terms under which we can exchange present goods for future goods, and the desires of the community to consume now or to consume later. These forces, I think, ought to be allowed to find their equilibrium position.

Alternatively, we can decide that we want to hold the interest rate at a particular level. If we make that choice then the quantity of money becomes the variable, and possibly the level of prices.

My feeling is that the quantity of money is a more neutral instrument for achieving price level stability. If we achieve price level stability or full employment or some admixture of the two by regulating the quantity of money and by appropriate fiscal policy, then the interest rate will adjust to balance appropriately the desires of the community for present and future consumption according to what our technology allows. So I think the interest rate will achieve a proper level if we determine that the quantity of money shall be maintained at a proper level.

Mr. BROCK. I agree—not perhaps for exactly the same reasons—but it seems those who advocate a fixing of the interest rate level seem to presume we are operating in a vacuum, and we are not.

You cannot, in this world. We have a large trade with the rest of the world. We are again getting into the problem of balance of payments. But it does have an impact on this economy. There is no question about it.

And if you try to set your interest rates, you are affecting that balance and our economic structure overall as if you were in a vacuum, and, therefore, you could be creating some very serious problems; whereas, money supply is an approach which is technically possible, I think.

Thank you very much.

The CHAIRMAN. Mr. Minish?

Mr. MINISH. No questions.

The CHAIRMAN. Mr. Harvey?

Mr. HARVEY. No questions, Mr. Chairman.

The CHAIRMAN. Talking about a limit on the interest rates, you gentlemen would also be opposed to fixing a floor on interest rates, too, would you not?

Mr. STROTZ. Certainly.

The CHAIRMAN. Recently we have witnessed the Treasury and the Federal Reserve, acting together, which to some represents almost a conflict of interest—I don't want to use the word conspiracy—that indicates something criminal, I guess. But here they were working together, and in my book, in this case it looks like they were working against what I consider to be the public interest by arbitrarily forcing an increase in short-term interest rates.

You have witnessed that, you noticed that.

And while you would be opposed to having a ceiling on interest rates, you gentlemen have stated, as many others have, you would also be opposed to arbitrarily increasing interest rates.

Mr. JOHNSON. Yes, sir.

Mr. STROTZ. If I may comment on that, sir, I think the question of what the interest rate ought to be has been regarded as a policy problem. I think it would be better to look instead at the price level or the quantity of money. But we have been looking at the interest rate.

It has loomed very large because of our concern about our gold position internationally.

However, if it is permissible in good humor, for one to chide a Congressman, I might suggest that the notion that the Treasury and the Fed have been working hand in hand is something that the bills under discussion today are intended to bring about as a permanent arrangement. I think they ought to work hand in hand.

I may object to the particular policy that is being pursued at a given moment. But the worst is if the Treasury wants to move interest rates in one direction and the Fed in another. I think their working hand in hand is not something that we should complain about.

The CHAIRMAN. My greatest concern is the private banking interests being represented on boards that have to do with determining the volume of money and the cost of money.

Now, you gentlemen mentioned, each one of you, that this should be a question—questions like these should be left to dedicated public servants. You didn't use that language, but I inferred that is what you meant.

But I don't think you commented directly upon the Open Market Committee. Now, of course my principal complaint here is that the Committee is operating in violation of the law.

The Open Market Committee is really in a sense separate and distinct from the rest of the Federal Reserve. When the Open Market Committee meets each of the 12 people on the Federal Open Market Committee, each one has a separate hat. He takes off the hat he wears as a member of the Federal Reserve Board, or as President of one of the 12 Federal Reserve banks, and he puts on the hat of the Federal Open Market Committee.

Now, consider the Presidents of the 12 Federal Reserve banks. They are selected by a nine-man Board of Directors, six of whom are selected by the private banks. So that gives them two-thirds of the Directors to elect the President.

Now, when these Presidents are elected, contrary to general belief, they don't even take an oath to support the Constitution of the United States, or to carry out the policies of the Government, or anything else. It is only when they take that hat off and put on the Federal Open Market Committee hat that they take an oath, the statutory oath.

So there is a difference there.

And so we have, for all practical purposes, these 12 selected Presidents of Federal Reserve banks, selected by the private banks, going into the secret room where the Open Market Committee meets every 3 weeks, along with 7 public members, the Board of Governors, and that means the lineup is 12 to 7. Therefore, I say it is in violation of the law. The law requires the public members be a majority. And this committee, operating with only 7 public members to 12 private, takes such actions as they desire to take concerning the most important thing affecting our economy—that is, the value of money, the cost of money, and the quantity of money.

I just cannot see where this should be permitted.

Do you gentlemen—would you like to express yourselves definitely on the policy now, and contrast it with what you think it should be in that respect?



Mr. STROTZ. My competence does not enable me to comment on whether there is a violation of law.

The CHAIRMAN. The law says the Committee should be composed of 12 members, 7 public and only 5 private.

Mr. STROTZ. I am prepared to comment on the institutional arrangement, which is, of course, something that has developed over time in response to recognition of the importance of open market operations.

My feeling is that the Open Market Committee is a Committee that has tremendous power over the Nation's supply of money, its price level, its level of employment, its foreign trade position, its rate of economic growth. My feeling is that any agency that has that power ought to be responsible in a direct and immediate way to the executive or the legislative branch of Government.

I think that the institutions we have at present are not desirable. They have grown up through the fortunes of history.

I think it is desirable to alter them, and I would support you in the wish to bring this authority more directly under the control of the executive branch.

The CHAIRMAN. Thank you, sir.

Mr. JOHNSON. I subscribe completely to my colleague's view on this. I feel, as he does, that the Open Market Committee is a very powerful Committee, and has a tremendous impact on employment and prices. Therefore, in a democratic society, which we believe in, this Committee should come under the influence and have responsibility to the executive branch of the administration.

Consequently, I support your views on this, also.

I think that at a minimum all the members of the Open Market Committee should be appointed by the Executive.

The CHAIRMAN. And confirmed by the Senate.

Now, I don't remember that you gentlemen stated your views on taking off this requirement that banks cannot pay interest on the bank deposits. What is your view on that?

Mr. STROTZ. I should like to see them permit it, to pay interest on bank deposits.

The CHAIRMAN. In other words, permit the interest payments?

Mr. STROTZ. Yes, indeed.

Mr. JOHNSON. I feel the same way, sir.

The CHAIRMAN. Mr. Hanna, would you like to ask some questions?

Mr. HANNA. No, sir.

The CHAIRMAN. Mr. Reuss?

Mr. REUSS. I would like to explore with you gentlemen a bit about the process by which increases in the money supply do some economic good. While I am in no way critical of your contributions this morning on this point, some of the gentlemen who have testified before us have, I think, been insufficiently practical in their discussion of the money supply.

Let me phrase my question in terms of the current tax cut: By and large, the present tax cut remits about \$10 billion in taxes to individuals. The theory is that consumers—let's leave corporate tax reductions out of this for the moment—will spend 9 out of 10 of the dollars left in their pockets. This expenditure will in turn result in additional expenditures of \$9 billion.

So out of a tax remission of \$10 billion, you get maybe \$18 billion or a little more in terms of added economic activity.

So runs the theory, roughly speaking.

Now, suppose instead of Mr. Dillon, who advocated this tax cut, we had had a Secretary of the Treasury, who had said, "No, we won't have a tax cut. That unbalances the budget and hurts the revenues. We will do this by monetary policy. We will create \$10 billion worth of new money in 1964, leaving taxes and spending where they otherwise would be."

I have asked you to bear with me up to this point, so I can present my question.

What would be the effect of that additional \$10 billion, pumped into the economy via monetary policy, as opposed to the effect of the additional \$10 billion pumped into the economy by cutting taxes?

Before asking you to answer, I would make a couple of observations.

If you do it by monetary policy, is it not much less certain that it will be spent on new investment or on consumer goods than if you do it by tax policy. More money available to banks may simply mean that they will bid up certain existing assets—even though this doesn't result in a general inflation.

Secondly, who gets what under an addition to the money supply? If you reduce taxes at the bottom end of the tax spectrum, you know who gets it. Poor people get it, and they spend it, so you not only get maximum spending, but you get some joy out of helping those less fortunate members of society.

The CHAIRMAN. Will you yield for a short observation, Mr. Reuss?

Mr. REUSS. I certainly shall.

The CHAIRMAN. I think you will find in 1958, when there was a large deficit, the Fed increased its holdings of Government bonds by \$2 billion and the commercial banks increased theirs by \$8 billion. Maybe the Fed didn't pump hard enough, but what funds the Fed did pump into the System were not used as you indicated they should be, and in other ways where they would be helpful to the people.

Mr. REUSS. Of course, I hope it is not as bad as you suggest, Mr. Chairman. What you just said gives easy money people like you and me some concern. I hope we can get more economic stimulation than that.

If that is all that easier money does, enable the banks to bid up the price of Government bonds, then we easy moneyites have got to do some more thinking.

You have brought me face to face with the worst now.

Mr. STROTZ. I would say that it remains problematical just how effective monetary policy or central bank policy can be, and its effectiveness no doubt differs, depending upon the problems and conditions that are confronted.

The mechanism through which it would be effective is that the central bank, by increasing the available reserves as a basis for loans of the commercial banks would induce the commercial banks to lower interest rates. A consequence of the reduction of interest rates would be an increase in the amount of borrowing and spending. That probably would typically be investment expenditure, and to the extent that the mechanism worked in this way, monetary policy would have a somewhat different impact in the first instance than, say, a reduction

in tax receipts from people in lower income brackets. Though once they spend, too, this also would stimulate investment.

I think that when we look at the recent tax cut, we ought, however, to realize that it is not only on people in the lower income brackets, but also on corporations. I would find it difficult to know what the relative distributional effects may be of the tax cut as against an alternative effort to expand the economy through monetary policy.

Mr. REUSS. Because of our mutual difficulty there, I set up my model as if the tax cut were limited to individuals.

Mr. JOHNSON. Let me comment on this, sir, if I may.

Of course, you raise some substantive issues.

First, regarding fiscal policy; it is not at all clear that if you cut taxes you will achieve the desired effect. I believe in the tax cut. But I think one should realize that it is not all cut and dried as one might infer from a very simple Keynesian model, where current consumption is uniquely a function of current disposable income, and you increase disposable income, the marginal propensity to consume so much and people spend money, and so forth. I think we all hope this is true.

But it may very well be that people will see their increase indisposable income, retire debt, and so forth.

So you have a problem here regarding whether the tax cut will be effective or not. I hope it will be effective.

Another point on your question regarding an alternative of promoting domestic expansion through an increase of the money stock; you raise a question of the transmission mechanism. That is to say, you generate an increase in the stock of money, therefore, what is the mechanism through which it is transmitted into an increase in spending.

Let me be perfectly frank with you on this. The detail of the transmission mechanism, I think, is very complex. I don't understand it. This is a very nebulous area.

Mr. Friedman himself, I think, would agree that it is very difficult to explain completely the mechanism that links a change in the money supply to economic change; how the influence of a change in the money supply is transmitted to the levels of income and output; what sector of economy will be affected first, and so forth.

But one can be an empiricist here and say that one observes in the real world that when there is an increase in the stock of money there follows, with some lag, an increase in income. I have enough faith in this relationship to use variation in the money stock as a device to help stabilize the economy.

Therefore, I would say one would, without knowing all the details of how it actually gets into the system, get an expansion in income and employment if the money supply were increased. But it would be through a different mechanism, of course, than the tax cut.

Mr. REUSS. Let me state to you gentlemen how I view this process, having listened for a number of years to a great many expert witnesses.

I suggest to you that it is a mistake for Professor Friedman—perhaps I should not use the name—to lead us to believe that merely cranking out an adequate supply of money is all by itself going to produce a full employment, no inflation economy.

I suggest instead that an adequate supply of money is needed to attain full employment, but to bring about full employment, other measures are essential. Taxing less, spending more, antitrust measures, and other actions are needed to insure that consumer demand will be adequate. Once you have done this, investment tends to respond to that actual or projected consumer demand.

You can, however, chill off investment quite markedly by starving the money supply. And, therefore, I would view money supply as something that must, in the national interest, be kept at an adequate level year in and year out.

But to say that doesn't say that merely providing an adequate money supply is going to achieve the full employment goals of the employment act.

In other words, and to summarize, while it is true that when you have full employment and good national growth, as you do in Europe and as we have had here in the past, you add an adequate annual increment to the money supply—that alone is not what did it. The availability of money prevented the chilling off of economic expansion that came basically from tax policy, fiscal policy, psychology, entrepreneurial oomph, or whatever else is going in the economy. Money doctors make a mistake when they assume that money supply was all that was needed.

What I have said doesn't absolve the Fed from any of its sins in recent years. But I would put the proposition I have just announced to you gentlemen and ask you whether you disagree with it.

Mr. STROTZ. I think that I am in basic agreement with what you have said. I am not yet convinced, like Professor Friedman, that there is so neat and stable a relationship between the quantity of money and the level of economic activity that we could adopt a simple formula. Though it should be understood that his main reason for advocating it is not that it would work perfectly, but that it would work possibly better than more arbitrary measures often based on improper forecasts have worked in the past.

Mr. REUSS. Of course he may be right in saying that unless we have a given increase in the money supply you are going to choke off expansion forces in the economy.

Mr. STROTZ. Yes. And I would not agree certainly with his staunchest opponents, who would argue that it makes practically no difference. I think it is one weapon in the arsenal. What its effectiveness may be is not clear to us and may vary over time. We should use it wisely.

If I might, I would like to extend my comment on another but related point. I spoke earlier of the effectiveness of an increase in bank reserves in increasing the amount of money and level of economic activity through a reduction in the interest rate. Statistical studies of the determinants of business investment in both plant and equipment, and in inventories, especially for the manufacturing sector, have never demonstrated very conclusively that the rate of interest has much effect. In part, this is a problem of statistical techniques.

But we use the term "interest rate" to cover many things, and my guess is that the sort of records we use, as to what has happened to the interest rate, misrepresent what has actually happened.

My feeling is that there is a great deal of flexibility in the lending policies of commercial banks, without any changes in interest rates, in

terms of how banks see the quality of credit opportunities. I think this is, however, an area in which we need to know much more, and this is very critical to our understanding or appreciating just what may be the power and the limitations of changes in bank reserves and the supply of money on the level of economic activity.

Mr. JOHNSON. I would like to comment on this, also, sir. I share the tone of your observations regarding pat formulas for controlling the money stock. I think that we do not know all there is to know of the detailed relationship between a change in the money stock and spending.

Also, I would not abolish discretionary monetary policy and substitute for it some pat rule like increasing the money stock at some constant predetermined rate.

However, I think that this is somewhat neither here nor there from the point of view of the present problem confronting monetary policy. That is to say, even without knowing the whole transmission mechanism, and recognizing there are honest differences of opinion by economists on the precise role of money, I think in times of underemployment the Federal Reserve should embark on expansionary monetary policy. But I do agree that we cannot base everything on some unique rate of change in the money supply for the reasons you suggest, coupled with other factors that one could specify.

Mr. REUSS. I was not necessarily suggesting that we shouldn't have a Friedmanesque annual rate of increase in the money supply.

What I was suggesting is that you cannot do that and then relax and say, "Splendid, we have now produced—seeing that we have an adequate increase in the money stock each year—a full employment without inflation economy."

If demand is insufficient, you can attempt to increase the money supply, but the increase will go not to consumers or investors who will spend it. It will be offered by banks as loans to businesses. And if times are not good, businesses can say, "No, you can offer that money to me for nothing, but since I see no prospects for profits and I have to pay back the loan, I will not borrow the money."

So it will go into existing assets, such as outstanding bonds or to the stock market, where its economic benefits, if any, are much more confusing, or into Government securities.

Mr. BROCK. I would simply like to comment that what we are saying, it seems to me, is that it is permissive rather than causal.

Mr. REUSS. "Permissive," meaning that if the money supply is not adequate, you may be frustrating that which you are achieving by other means, and "causal" meaning that increasing the supply of money would directly cause an increase in economic activity.

I think those are good words, thank you.

Mr. BROCK. I appreciate the fact that we are in agreement on that.

Mr. VANIK. I have no questions.

I would like to say, Mr. Chairman, that the testimony—I have come late, but I have read it over—is certainly some of the very best evidence we have had before this committee. And I certainly appreciate the time you gentlemen have put into this hearing. It makes me feel some of the best things are coming toward the end of our discussion.

Mr. REUSS. I would have just one more question.

Both of you, in answer to my last question, volunteered some disquiet about advance formulas on increases in the money supply.

I have been concerned, as a member of this committee, now that my attention has been called to it, in realizing how archaic and dodolike are the admonitions of Congress to the money managers.

The Federal Reserve Act of 1913 contains some very Victorian injunctions about elastic currency and the needs of commerce, which are not really written for 1964 and the years to come at all.

Do either of you gentlemen see the need for Congress, which has the constitutional power to coin money and regulate the value thereof, having delegated most of this power to the money managers of the Federal Reserve, to give them better instructions than the vague bits of rhetoric we gave them 50 years ago? You know the language in the law.

Mr. STROTZ. Yes. I think this language not only is inappropriate to the situation today, but was inappropriate in 1913. But I think we understand that better today than we did in 1913.

I have much sympathy for the notion of a rule that our money managers should follow, though I think the rule from time to time must be revised. I think, nevertheless, it would be a good idea if the Federal Reserve System were to state some longer run objectives and determinations and adhere to them more steadfastly, even in its day-to-day operations.

I think clarity of what we are trying to do and propose to do is almost as important as having a stable value of the dollar in the first place.

Mr. JOHNSON. I share Professor Strotz observations. I would also say the following.

I feel that the Federal Reserve should be more concerned with long run problems. Also, I feel if you really examine monetary policy carefully, it is only a means to an end, of course. All the instrumental variables of the Federal Reserve the open-market operations, the discount rates, and so forth, these are just means to achieve some other end.

The other end, of course, is full level of employment and price level stability.

So, consequently, I would like to see the central bank be more concerned with longrun goals, with the ultimate target variables, than worrying about the everyday matters of the money market.

So I think they should worry more about longrun roles of employment and growth than monetary and banking conditions. This implies that they should place more importance in the money supply and its rate of change.

The CHAIRMAN. We are grateful, Professor Johnson, and Professor Strotz, for your help this morning.

The committee will now stand adjourned subject to the call of the Chair.

(Whereupon, at 11 a.m., the committee recessed, subject to the call of the Chair.)



# THE FEDERAL RESERVE SYSTEM AFTER 50 YEARS

WEDNESDAY, MARCH 25, 1964

HOUSE OF REPRESENTATIVES,  
SUBCOMMITTEE ON DOMESTIC FINANCE OF THE  
COMMITTEE ON BANKING AND CURRENCY,  
*Washington, D.C.*

The subcommittee met, pursuant to recess, at 10 a.m., in room 1301, Longworth House Office Building, Hon. Wright Patman (chairman) presiding.

Present: Representatives Patman, Reuss, Vanik, Hanna, Kilburn, and Widnall.

The CHAIRMAN. The committee will please come to order.

Today, the Subcommittee on Domestic Finance resumes its hearings on the Federal Reserve System.

We are attempting to obtain complete information again in as short a time as possible. Of course, we cannot meet every day because the full committee has other important business but today we are privileged to have Mr. Nathaniel Goldfinger as our witness on the Federal Reserve.

Mr. Goldfinger is the distinguished director of research of the American Federation of Labor and the Congress of Industrial Organizations. I am sure that what he has to say on the Federal Reserve will be most interesting and enlightening and extremely important to the purposes of our inquiry because what the Federal Reserve does has tremendous effects on all working people in our Nation.

You may proceed in your own way, sir. I notice you have a statement.

## STATEMENT OF NATHANIEL GOLDFINGER, DIRECTOR, DEPARTMENT OF RESEARCH, AMERICAN FEDERATION OF LABOR AND CONGRESS OF INDUSTRIAL ORGANIZATIONS

Mr. GOLDFINGER. Thank you. For the record my name is Nathaniel Goldfinger. I am the director of the department of research of the AFL-CIO, and I will submit the statement for the record.

The CHAIRMAN. It will be inserted at this point and you may handle it any any way you desire.



(The statement referred to above follows:)

STATEMENT OF NATHANIEL GOLDFINGER, DIRECTOR, DEPARTMENT OF RESEARCH, AMERICAN FEDERATION OF LABOR AND CONGRESS OF INDUSTRIAL ORGANIZATIONS

This committee deserves the Nation's gratitude for focusing attention on monetary policy and the Federal Reserve System.

For a decade, unemployment has been in a rising trend. Even last year, when the real volume of national output rose nearly 4 percent, unemployment increased. This key domestic problem of unemployment and underemployment is poisoning race relations and creating difficulties in labor-management relationships, as well as wasting manpower resources. Moreover, for the unemployed, underemployed, and their families the lack of gainful job opportunities causes obvious distress.

The Nation's monetary policy during the past decade has contributed to this condition. During much of the past decade, monetary policy has been relatively tight and interest rates have been relatively high—discouraging the needed expansion of demand for goods, services, and manpower. Moreover, monetary policy decisions were factors in setting off the three recessions since 1953.

During the past 3 years, the Federal Reserve—the Nation's monetary managers—has fortunately been more positive in its role. But interest rates—the price of money—which were pushed upward during the 1950's are at high levels and unemployment remains about 5½ percent of the labor force. Yet it is not monetary ease that is now the primary concern of the Chairman of the Federal Reserve.

In 1964, America once again faces a potential threat from the Federal Reserve—monetary policy may be used to negate the demand-generating and job-creating impact of the tax cut. Once again, the Nation's monetary policy may be tilting with the windmills of overall demand inflation or ineffectively responding to a balance-of-payments deficit, leaving persistent, high levels of unemployment in its wake.

Monetary policy is frequently thought of as something esoteric. But it is a powerful governmental tool, affecting incomes, sales, and employment. Certainly, in the world of the 1960's—with high unemployment, the spread of labor-displacing automation and the influx of millions of youngsters into the labor force—America cannot afford further experiments with growth-inhibiting, unemployment-generating policies.

America needs job-creating expansion in 1964 and through the remainder of the 1960's—not restrictive tight money and high-interest rates. America needs a high rate of economic growth, consistent with our rapidly growing labor force and rising productivity—to bolster international confidence in our economy and in the U.S. dollar—and not growth-inhibiting measures to deal with balance-of-payments difficulties that can best be handled by other and more direct means.

Unemployment is clear evidence of our past failures in economic policy, including our monetary policy. The balance-of-payments difficulty must not be "solved," at present, by perpetuating high levels of unemployment and underemployment.

Monetary policy must be geared with the Nation's fiscal policy—to encourage economic expansion and the creation of the millions of new job opportunities required to achieve and sustain full employment. Formal means of coordinating monetary and fiscal policies are needed so that the Government's key economic policies can jointly encourage expansion.

For this purpose the Federal Reserve System must become a public system, broadly representative of the American people and responsive to the needs and desires of the American people. The Nation's monetary management is much too pervasive in its influence to be left in the hands of people whose training and experience are mainly in big business and banking and who are further insulated from the major currents of American life by the "independence" of the Federal Reserve. The entire Federal Reserve System must be made into a public system, fully a part of the U.S. Government and broadly representative of the population.

Monetary policy formulation must be brought within the fold of the U.S. Government—and not left outside.

The major guide to America's economic policy is the Employment Act of 1946, which commits the Government "to promote maximum production, employment, and purchasing power." This should be the guide not only for the Council of Economic Advisers and the Treasury, but for the Federal Reserve as well.

#### COORDINATION OF MONETARY POLICY WITH FISCAL POLICY

Coordinated monetary and fiscal policies are essential for the success of complex modern economies. Money creation and control, as well as taxation and Government spending, must be positive and sufficiently expansionary and growth-generating forces for economic balance and strength. Balanced economic growth generally requires an ample, growing money supply at relatively low interest rates. If fiscal policy, however, is designed to encourage, and monetary policy to discourage expansion, the result can be a zero effect or serious economic distortion. Push and pull conflicts from such monetary and fiscal confusion can wreak havoc on a nation's economic performance.

The problem of coordination seems particularly acute this year, in view of the first general tax cut in a decade. The threat of tight money to negate this cut is a threat to the economic well-being of every American.

The problem of coordination also involves the balance-of-payments measures taken by the Federal Reserve in the past and their possible repetition in the future. Once again, payments pressures are given as possible reasons for "tightening money" if the "market forces" call for this kind of action.

These two issues make especially timely this committee's examination of the need for further changes in the 50-year-old Federal Reserve System. This committee has rekindled the debate about American money management which has persisted throughout the Nation's history. Unlike many other groups in America, the AFL-CIO not only welcomes this debate, but considers the dialog on monetary policy an important contribution to the Nation's economic progress.

Three of the issues raised in this committee so far—the tax cut, the international payments problem, and the so-called independence of the Federal Reserve—really point to the need for coordination of policy in an exceedingly complex economy.

The AFL-CIO has consistently viewed monetary policy as a subject of concern to every American. What the Federal Reserve System decides can affect job opportunities of men and women all over America. What the Federal Reserve decides affects the cost of money, of cars, of houses, of doing business, and the upward and downward trends of business cycles. No one knows precisely how much money creation should be used. In general, however, monetary ease is expansionary and therefore beneficial to the American people until such time as actual inflation is enough of a threat to warrant counteraction. Even then, it is often more effective to treat the specific causes of inflation directly at their sources, rather than indirectly, because monetary policy is so imprecise in its effects.

The AFL-CIO has always viewed these concerns as the valid business of every American citizen in a democracy and has insisted on the need for democratic machinery to assure fair representation of interests in determining monetary policy. There is not now and has not been any intention to question the integrity or impugn the motives of the bankers, businessmen, technicians, and representatives of other interests who have served on the Board of Governors, the Federal Open Market Committee, or the Boards of the 12 Reserve banks. But an important Government economic tool, such as monetary policy, should not be left in the hands of a select group, whoever they are.

Moreover, the AFL-CIO has questioned and will continue to question the validity of pretending that classical free market competition applies to the money market. The Federal Reserve, created by the Congress, has a responsibility to conduct a public system, to control the supply of money and credit in coordination with the remainder of the U.S. Government, for carrying out governmental policy. The money market is not and cannot be a classical-type free, competitive market. The Federal Government is not a mere participant, but a dominant force in the money markets of the United States as every government in every major industrial nation is and must be. As the Commission on Money and Credit expressed it: "Control over conditions governing the quantity of money is inevitable in a modern industrial society."

The major concern of a democratic society is not the freedom of money or markets, but the freedom of men. Worship of free money markets can possibly destroy the freedom of men, just as effectively as runaway inflation can destroy their economic well-being. The persistent inference that representative government means runaway inflation, unless some superboard made up almost exclusively of technicians or bankers filters out all such possibilities, is offensive in a democratic society and is disproved by America's economic history.

The Federal Reserve System must be made a regular part of the Government. In the words of Prof. Paul Samuelson:

Let me make clear that all this is stated from the standpoint of one who philosophically values individual freedoms. A person who cheerfully accepts the idea of direct price, wage, and production controls can afford to give a relatively large measure of freedom to credit institutions; but one who wishes to minimize

(except in emergency periods) the use of such direct controls will realize that we maximize total freedom in a society by limiting it in the areas which crucially determine the aggregate of effective demand. ("Reflections on Central Banking," *The National Banking Review*, vol. I, No. I, September 1963, p. 16).

In short, the independence of the Federal Reserve is not really at issue. The Federal Reserve is either a Government agency, operating effectively under Government direction, or it is operating outside the constitutional authority of the United States. The coordination of the Federal Reserve with other Government activities and other Government credit agencies is at issue. The reason for this is clear from the following quotation from the Commission on Money and Credit:

On the record of the postwar years, the simultaneous achievement of low levels of unemployment, reasonably stable prices and an adequate rate of growth will require finer adjustments in the use and coordination of the tools of economic policy than our Government has so far been able to manage. It is a task for the sixties to do better.

To do the job that is required, coordination of monetary and fiscal policies is essential. Changes in the structure and composition of the Federal Reserve System—which I will discuss in detail later—can effectively coordinate monetary policy with the Government's tax and expenditure policies. Moreover, formal procedures should be developed—through a top-level interagency committee, for example—to maintain communication and coordination of the Federal Reserve with the Treasury, Commerce, Labor, and State Departments and the Government's credit agencies.

#### MONETARY POLICY IN THE 1950'S

From 1953 through 1960, the Federal Reserve System followed a general policy of tight money and rising interest rates except during economic declines. The money supply has expanded at a rate of only about 2 percent a year throughout the postwar period. Recently, it has been rising at a rate of roughly 4 percent. Many economists have indicated some agreement with Professor Gurley's comment to this committee: "Monetary policy has been a tightwad, doling out money in dribbles when more was called for." It is significant that the supply of money (demand deposits and currency in circulation) has declined from 35.1 percent of GNP in 1953 to 25.7 percent of GNP in 1963.

The argument among theorists about "near money" or the possible need for an automatic increase of the money supply will go on for some time. I will not discuss it here. We do know that America has grown too slowly for its needs since 1953 and surely money and credit policies contributed to this slow growth rate and accompanying rise of unemployment.

A recent article in the January 1964 *Challenge* magazine by the New York Times journalist, M. J. Rossant, which praises the Board and its chairman for their political flexibility and their shift to new conditions, explains the behavior in the 1950's as follows:

In the 1950's, when the revival of flexible monetary policy took place, the money managers did not make the best use of their tools. On the contrary, they restricted their choice of weapons and utilized them in a very limited way. This addiction to classic central banking theory was inconsistent with the Fed's responsibilities under the Employment Act of 1946 and its commitment to promote noninflationary growth.

That seems an accurate statement of the case.

## MONEY POLICY IN THE 1960'S

Despite some recent improvements in Federal Reserve actions, America has high money rates in 1964, whatever the precise determination of the proper money supply. The Federal Reserve has a power and a duty not only to create an elastic money supply, but also to provide enough credit. We, therefore, hold the Federal Reserve System responsible for the fact that its lack of positive policies from 1953 to 1963 have left the United States in 1964 with high interest rates—for every type of paper, so that the cost of money is at high levels. It may comfort the bankers, but it gives us no comfort to read in the *Wall Street Journal* of January 24 that “the cost of borrowing at the bank is threatening to climb to the highest level in 30 years.”

Talk of raising the prime rate to 5 percent continues and gets louder—and it is not reassuring to know that that is still below the historical peaks of 7 percent in 1920–21 and 6 percent in 1929. Since the end of 1962, the Federal Reserve has continued to reduce free reserves from roughly \$400 to \$500 million to about \$300 million in early 1963 and, since mid-1963, to about \$100 million or lower—affecting all rates.

Unlike some monetary theorists and technicians who have testified that the amount of credit and money supplied were just about right in 1963, I want to go on record here to say that enough money and credit does not mean that credit and money are low enough in cost for the well-being of the Nation as a whole. Mortgages have receded in cost, but they are still at 1958 levels. They are not inexpensive. Municipals were lowered, but again are up.

A look at the past decade of activity—the 1950's and early 1960's—is therefore a story of an upward tightening of interest rates, so that what has been “influenced” upward by the Federal Reserve for anti-inflation or anti-balance-of-payments-deficit purposes, has not come down. Money is expensive in America. The higher price is paid by car borrowers and homebuyers and the small business people whose cash reserves, unlike those of large corporations, do not allow them to escape the effects of expensive money rates. The effects of many years of tight money and high interest rates are with us and there is a danger of a further tightening and lifting of rates this year.

## THE TAX CUT OF 1964

At present, the unemployment rate persists at about 5½ percent of the labor force. Idle productive capacity also persists, with industry's operating rate at approximately 85 to 87 percent of capacity. Despite the rising sales, soaring profits, stock splits, and increasing dividend payments of the past 2 years, considerable economic slack continues. And with both productivity and the labor force growing rapidly, after 10 years of substantial slack, it is no wonder that America is plagued by persistent idle manpower and productive capacity.

To stimulate greater expansion of the economy, Congress adopted a substantial tax cut. Not even the most optimistic proponents of the economic stimulus of the tax cut believe that maximum levels of operation and full employment will be reached before 1966; it should

be noted that, in the AFL-CIO view, the tax cut, alone, will not achieve full employment.

As for 1964, the Council of Economic Advisers expects a decline of the unemployment rate from 5.7 percent last year to only about 5 percent this year—still leaving a high level of joblessness. With industry now operating at about 85 to 87 percent of capacity and new installations due to increase capacity in 1964, a rise in output of about 5 to 6 percent or so will still leave industrial operations considerably below capacity and below industry's preferred operating rate of about 92 to 94 percent.

There is no expectation of widespread labor shortages or production bottlenecks. Rather, the expectation is for improvement in 1964, with continued slack. Yet there is a threat, a real danger, that the Federal Reserve may move to tighten money and increase interest rates, with the obvious effect of negating all or part of the expansionary stimulus of the tax cut.

The President's economic message to Congress warned :

A strong upswing in the economy after the tax cut need not bring tight money or high interest rates \* \* \*. It would be self-defeating to cancel the stimulus of tax reduction by tightening money.

The Chairman of the Federal Reserve has told this committee, however, that he cannot tell whether or not a further tightening of monetary policy will be necessary in his view.

Chairman Martin apparently quite reasonably denied his knowledge of the future and said that an inflationary development would necessitate tighter money. Why would anyone argue with that approach? Because it is clear that aggregate demand inflation, which can be curbed by a tight money policy usually does not exist when there is a 5-percent unemployment rate. And there is a history of the Federal Reserve tilting with the windmills of overall demand inflation in the 1950's, with the resultant trend of rising unemployment.

The Federal Reserve's continuing fear of inflation is notorious. Prof. Dudley Johnson has called this inflation fear a Federal Reserve "neurosis." On the other hand, there is a constant displeasure with, but no real fear of persistent high unemployment, which has continued in this country for over 6 years.

It is not unreasonable, then, for those of us who criticize the Federal Reserve for its recession-preceding, money-tightening actions of 1957 and 1959 to wonder how much additional damage can result from mistaken inflation fears in the 1960's. As Walter Heller, Chairman of the Council of Economic Advisers, has put it :

Tighter monetary policy cannot police inflation without arresting expansion of employment and output—and, as noted, both output and employment are still well below potential.

This fear of inflation, which has directed Federal Reserve policy for a decade, has kept the Board from taking positive steps to contribute to maximum employment in America through a positive, expansionary money policy. Instead, the influence of the Board throughout the 1950's, as we have seen, was to act to tighten money whenever an upswing was underway and to remain passive at other times. As the Commission on Money and Credit explained—

a shift to restrictive policy is often passive; it takes the form of failing to increase reserves in the face of a rising demand for credit.

Just as Chairman Martin is certain that "inflation creeps upon you," with a memory of the past, I fear that he will see "inflation" where it is not, and quite honorably attempt to destroy it. The result will be disastrous at a time of already tight money and high unemployment. We cannot afford such loss again—with a 5½ percent jobless rate and unemployment rates two to three times that level for Negroes and young people.

Moreover, Chairman Martin has told this committee that—

as long as we are running a deficit in this country, we have to finance that deficit. And I insist that the major portion of any Federal deficit should be financed out of bona fide savings, and not out of created money.

Such monetary policy will cancel out all or part of the expansion impact of the tax cut. As Professor Johnson of the University of Washington stated :

If the budgetary deficit is financed from the real savings of the community in order to avoid worsening the U.S. balance-of-payments situation—i.e., if there is no increase in the money supply—the Government expenditure multiplier may be zero or even negative.

Canceling the tax cut will leave us where we were or a little further behind—in terms of idle manpower and productive capacity. Moreover, it would negate actions by the Congress and the President to stimulate the expansion of the economy. Such danger should be averted. No block should be placed in the road to prevent the economy from moving up, as rapidly as possible, to a higher level of activities. Moreover, it should be the policy of the Federal Reserve to encourage economic expansion, in cooperation with the Government's fiscal policy.

#### BALANCE-OF-PAYMENTS PRESSURES

Concentration on balance-of-payments pressures, by the Nation's monetary managers, has led to growth-inhibiting monetary policies. Once again, in 1964, balance-of-payments pressures may become the justification by the Federal Reserve for tighter money and higher interest rates.

Resultant high unemployment and yearly losses of billions of dollars of potential output from economic slack are ineffective "solutions" to the balance-of-payments problem. The administration and the Congress and, indeed, the Federal Reserve Board, have already used more direct and more effective means of treating the payments problem.

Money-tightening efforts have not resulted in much lowering of the deficit but they have slowed domestic economic progress.

As this committee is well aware, deflation from such action can be serious. Once the forces tending toward deflation are great enough to affect the price level in the exceedingly imperfect competition of today's product markets, a real recessionary influence will have thoroughly taken hold.

In his discussion before this committee, however, the Chairman of the Federal Reserve Board said that "the forces of the market are the principal factors" to be considered. A more realistic analysis would indicate that U.S. economic expansion and technical international monetary arrangements in the past 3 years have much more to do with improvements in the payments deficit than classical free market forces.

International competition does not call for mass unemployment and losses of production in the United States.

Several direct measures to improve the balance-of-payments situation have been taken. Many more are needed—such as mechanisms to minimize adverse effects of private capital outflows.

The AFL-CIO Executive Council adopted a statement on the balance-of-payments last August which declared that—

America must not sacrifice the domestic economy and the welfare of American working people in dangerous and self-defeating attempts to solve the balance-of-payments problem.

I am submitting a copy of the AFL-CIO Executive Council statement for the record.

This statement by the leaders of organized labor makes clear that the U.S. export surplus—which is and has been substantial—should not be the only solution for international payments problems. However, in terms of its relative importance to the payments problem, certainly what happens to U.S. trade in 1964 will not be determined by the United States alone or only by the forces of the “free market.” The Common Market Vice President Marjolin recently has described inflationary problems in the EEC and suggested deflationary action for payments and other purposes. If such action is taken without hurting imports, the U.S. trade relationship with the EEC may continue to improve. Whatever the result, however, U.S. domestic policy should not be determined by EEC internal policy decisions.

#### THE FEDERAL RESERVE—A PUBLIC SYSTEM

The basic issues raised directly by this committee are not whether the tax cut should be negated or whether balance-of-payments pressures require slowing down progress at home, but whether or not the Federal Reserve Act should be changed. Review of the tax cut, inflation, and payments issues, is of great importance, because it clearly illustrates the great influence of the Federal Reserve. It also demonstrates the need to change the Federal Reserve System into a public instrument of public policy.

It seems obvious that changes are necessary in the structure and composition of the Federal Reserve System, particularly in terms of assuring more formalized coordination with the rest of the Government the System serves.

An official publication of the Federal Reserve’s Board of Governors states:

How is the Federal Reserve System related to production, employment, and to the standard of living? The answer is that the Federal Reserve, through its influence on credit and money, affects indirectly every phase of American enterprise and every person in the United States. (“Board of Governors of the Federal Reserve System, the Federal Reserve System, Purposes and Functions, Washington, D.C.,” p. 2.)

The Board of Governors and the Federal Open Market Committee members thus influence the lives of everyone. Under present law, all of the FOMC members are not even appointed by the President or the Congress, much less elected by the people. Members of the Board of Governors are appointed by the President, but their terms of office are not coterminous with the Chief Executive’s. The actions of the Federal Open Market Committee affect monetary policy, including debt



management, but there are no formal relations between the FOMC and the Treasury.

The Commission on Money and Credit declared :

What was thought of in 1913 as essentially a cooperative enterprise among bankers for the purpose of increasing the security of banks and providing them with a reservoir of emergency resources, has not ceased to be that. But it has also become one of the most potent institutions involved in national economic policy.

That much of a change requires, we believe, a change in the decision-making structure of the agency—particularly when that agency has such pervasive economywide impacts. The AFL-CIO does not believe that the Nation's central bank should be "a cooperative enterprise among bankers." The United States is a democracy and all of its people—not essentially monetary technicians, bankers, and commercial interests—should be represented in making decisions which affect everyone.

Therefore, it is my view that the terms of office of the Board Chairman and Vice Chairman of the Federal Reserve should be coterminous with the President's and they should serve as Chairman and Vice Chairman at the will of the President. Such a change would assure a degree of basic harmony between the President and the chief officers of the Government's monetary authority.

The terms of office of the members of the Board of Governors of the Federal Reserve should be reduced below the present, excessively long 14-year period. With overlapping and reduced terms of office, one term should expire each year or two.

In connection with the composition of the Federal Reserve System, due regard should be given to membership on the Board of Governors of competent people from the various economic groups in American society, including the trade union movement and consumers. Such a change in the composition of the governing body of the Federal Reserve System is essential if the Federal Reserve is to become a truly public governmental institution, broadly representative of the experiences and thinking of the major economic groups in American society.

A similar change is necessary in the composition of the governing structure of the 12 district Federal Reserve banks. Similarly, the Federal Advisory Council should be replaced by an advisory council, which should be, as the Commission on Money and Credit put it, "broadly representative of all aspects of the American economy."

Such measures are essential to broaden the composition of the governing authorities and advisory council of the Federal Reserve System. Until and unless such changes are adopted, the Federal Reserve will be subject to the charge that it is mainly dominated by the thinking and experience of bankers, big business, and monetary specialists. A public institution, as important as this Government agency, must be broadly representative of the major economic groups of American society.

In addition, the Federal Open Market Committee should be abolished. The current functions of the FOMC should be transferred to the Board of Governors of the Federal Reserve. That means that the determination of open-market policies, rediscount rates, and reserve requirements should be vested in the Federal Reserve Board.

Formal relationships should be developed among the Federal Reserve System and such departments as Treasury, Commerce, and Labor, the Council of Economic Advisers, and the Government's credit agencies—to assure basic coordination.

Moreover, it should be a matter of public policy, including the policy of the Federal Reserve Board, that the cost of money should be low enough and the money supply sufficiently ample to achieve and sustain maximum production, employment, and purchasing power.

Those who believe such a general policy is inflation producing have a view of inflation that is not in keeping with the productive potential of the American economy in the 2d half of the 20th century—with the spread of automation and rapidly rising productivity. Those who seem perfectly able and willing to accept and continue the unique quality of the Nation's Federal Reserve System—as an exceedingly independent central bank—seem unable to accept the unique quality of American economic conditions of the 2d half of the 20th century. Constant fear of aggregate demand inflation was much more appropriate in another era, when today's vast potentials of enormous production were impossible.

Inflation has not been America's enemy in recent years. Slow growth, unemployment, and underemployment have been America's real foes. Yet the Nation continues to lose billions of dollars of productive potential, because there are those in responsible positions who think in terms of an economy of scarcity and constantly fear inflation. The result has unfortunately been too painful to the millions who are unemployed and underemployed. The relatively poor record of our economic performance has raised doubts about the strength of the American economy.

Changes in the structure and composition of the Federal Reserve System would go a long way toward updating and modernizing national economic policymaking in the 2d half of the 20th century.

Mr. GOLDFINGER. Mr. Chairman, I will try to summarize the statement as briefly as I can.

For 10 years now we have had a rising trend of unemployment and even last year, in 1963, when the real gross national output rose nearly 4 percent, the level of joblessness continued to increase.

This to us, in the AFL-CIO, is the key domestic problem. This is a problem of unemployment and underemployment which is creating difficulties in labor-management relationships.

It is poisoning race relations, wasting manpower resources, and causing distress for several million families.

As I see it, the Nation's monetary policy during the past 10 years or so has contributed to this condition because during most of this past decade monetary policy has been relatively tight, interest rates have been relatively high and monetary policy in general has discouraged the needed expansion of demand for goods, services, and manpower.

It is true that during the past 3 years the Federal Reserve has fortunately been taking more positive actions. However, interest rates, which were pushed upward during the 1950's, remain at high levels while unemployment is at 5.5 percent or so of the labor force.

Now, in 1964, this year, we face a dangerous threat and that is the potential threat that the Federal Reserve System may tighten up in

this year and by tightening up negate the economic stimulus of the tax cut.

As far as we can see, in the AFL-CIO, America needs job-creating expansion this year and through the remainder of the 1960's. It does not need restrictive tight money and high interest rates. America needs a high rate of economic growth consistent with our rapidly growing productivity and rapidly growing labor force to bolster confidence in the American economy in the international arena and at home as well.

We certainly do not need, as we see it, growth inhibiting measures to deal with balance-of-payments difficulties that can best be handled by other and more direct means.

Monetary policy formulation must be brought within the fold of the U.S. Government and not left outside. Coordination, as we see it, is important, coordination between the monetary authorities, the Treasury, the Labor Department, Commerce Department, and the lending agencies of the U.S. Government.

The AFL-CIO has always viewed monetary policy as a subject of concern to every American because whatever the Federal Reserve System decides can affect the job opportunities, the incomes, and the employment of men and women all over the country.

No one knows precisely how much money creation should be used. In general, however, monetary ease is expansionary and therefore as we see it beneficial to the American people until such a time as actual inflation is enough of a threat to warrant counteraction.

And we, in the AFL-CIO have always viewed these concerns as the valid business of every American citizen in a democracy and we have insisted on the need for democratic machinery to insure fair representation of interests in determining monetary policy.

There is not now and has not been any intention on our part to question the integrity or impugn the motives of the bankers, the businessmen, and the monetary techniques, and the other people who have served on the Board of Governors, the Federal Open Market Committee, or the boards of the 12 Reserve banks, but an important Government economic tool, such as monetary policy, should not be left in the hands of a select group, whoever they are.

Now, to do the job that we think is required in the 1960's, coordination of monetary and fiscal policy is essential. Changes in the structure and the composition of the Federal Reserve System, which I will discuss a bit later, can effectively coordinate monetary policy with the Government's tax and expenditure policies.

Moreover, formal procedures should be developed through a top level interagency committee, for example, to maintain coordination and communication among the major economic and credit agencies of the Government.

Now, in looking back over the past 10 years we find that from 1953 through 1960 the Fed followed a general policy of tight money and rising interest rates except during economic declines. And, despite some recent improvements in the Federal Reserve actions, America now has high money rates.

The Fed has the power and the duty not only to create an elastic money supply but also to provide enough credit. It is our view, therefore, that the Federal Reserve System is responsible for the

fact that its lack of positive policies from 1953 to 1963 have left the country with high interest rates for every type of paper so that the cost of money is at high levels.

It may comfort the bankers but it gives us in the labor movement no comfort at all to read in the *Wall Street Journal* of January 24, for example, that, "The cost of borrowing at banks is threatening to climb to the highest level in 30 years."

Furthermore, we are disturbed by the continuing and increasing loudness of the talk that the discount rate will climb to 5 percent. Since the end of 1962 the Federal Reserve has continued to reduce the free reserves and they are now down to about \$100 million or lower affecting all interest rates.

At present the unemployment rate persists at about 5.5 percent of the labor force. Idle productive capacity, that is idle plant and equipment, also continued with industries operating at a rate approximately 85 or 87 percent of capacity.

Now, despite rising sales, soaring profits, stock splits, and increasing dividend payments for the past 2 years, there remains considerable slack in the economy.

And both productivity and the labor force are growing rapidly. It is no wonder that we are continuing to be plagued by persistent idle manpower and productive capacity.

With this as a background, the Congress adopted a substantial tax cut a few weeks ago but not even the most optimistic proponents of the economic stimulus of the tax cut believe that the maximum levels of the economic operations and full employment will be reached during 1964 and I would like to note here that we in the AFL-CIO do not believe that the tax cut alone will achieve full employment but that we need additional measures.

With all of this—the considerable slack in the economy, the congressional action to stimulate the economy—there still in no expectation of labor shortages or production bottlenecks this year. Rather, the expectation generally is for an improvement in 1964 but with a continuation of slack.

With this background there is a threat, a real danger that the Federal Reserve may move to tighten money, and cause an increase in interest rates, with the obvious effect of negating all or part of the economic stimulus of the tax cut.

Within the Federal Reserve System there seems to be a constant fear of demand inflation, a constant fear of too much employment, too much demand for goods and services.

This fear of inflation which has directed Federal Reserve policy for a decade at least has already kept the Federal Reserve System from taking positive steps to contribute to maximum employment through a positive expansionary monetary policy.

Instead, the influence of the Board through the 1950's was to tighten money whenever an upswing was underway and to remain passive at other times. As the Commission on Money and Credit explained, "a shift to restrictive policy is often passive; it takes the form of failing to increase reserves in the face of a rising demand for credit."

Canceling the tax cut, if that is what actually happens this year, would leave us where we were or a little further behind in terms of idle manpower and productive capacity.

Moreover, it would negate actions by the Congress and by the President to stimulate the expansion of the American economy. Such dangers should be averted.

No block should be placed in the road to prevent the economy from moving up as rapidly as possible to a higher level of activity.

Moreover, as we in the AFL-CIO see it, it should be the policy of the Federal Reserve System to encourage economic expansion in cooperation with the Government's fiscal policy.

This year, as in recent past years, the balance of payments along with the fear of inflation is an issue which the Federal Reserve has emphasized as an explanation and as a justification for possible tightening and for policies that tighten the money supply and increase interest rates.

As we see it, the balance-of-payments situation is a problem but grossly exaggerated in comparison with the substantial continuing problem of unemployment and underemployment in the American economy.

Deficits in the balance of payments of \$2 to \$3 billion or so, for example, are small by comparison with the total national output of \$600 billion.

And policies to restrict the American economy, which loses tens of billions of dollars each year, in order to possibly offset balance-of-payments deficits are wrong policies and are not necessarily effective because effective monetary policies, to get at the balance-of-payments situation, would be so deflationary as to throw us possibly into a severe depression.

What we are doing is largely ineffective in the area of monetary policy by the tightening to get at the balance-of-payments problem. There are much more, much better direct ways of getting at this problem such as steps which have already been taken, such as tying economic aid and such as steps that we in the AFL-CIO have advocated to curb the distortion that is created by the outflow of private capital.

In this regard, Mr. Chairman, I would like to submit a statement by the AFL-CIO Executive Council on the balance of payments which was adopted by the executive council on August 13, 1963.

The CHAIRMAN. It may be inserted at this point in the record.

(Statement referred to above follows:)

#### STATEMENT BY THE AFL-CIO EXECUTIVE COUNCIL ON THE BALANCE OF PAYMENTS

Fear of balance-of-payments deficits has been used to justify curbs on U.S. economic expansion, which fail to remedy the deficits, while they add to America's top economic problem—persistent high levels of unemployment and idle plants and machines.

America's difficulty is not payments deficits, in themselves, but the decline of international confidence in the dollar—the increased desire of foreigners, in the past several years, to exchange or threaten to exchange their dollar-holdings for gold at the U.S. Treasury, at America's fixed price of 1 ounce for \$35. This decline of confidence in the dollar is mainly due to continued economic slack in America, while the prosperous economies of Western Europe and Japan continue to grow rapidly.

Compared with America's unemployment problem, the balance-of-payments difficulty has been vastly exaggerated. Deficits of \$2.2 billion in 1962 and a yearly rate of over \$3 billion in the first half of 1963 are small by comparison with total national production of \$580 billion. America's great potential to produce, and not the large gold supply in Fort Knox, is the key to the Nation's strength.

The United States faces a payments difficulty, despite substantial surpluses of exports over imports—\$4.3 billion in 1962 and a yearly rate of \$4 billion in the first quarter of 1963. U.S. payments deficits result from America's unusual role, as the outstanding military and political leader, investor, and banker of the free world.

Since World War II, the American dollar has been the free world's major means of international exchange, in addition to gold and U.S. payments deficits have financed the expansion of world trade. But the decline of international confidence in the dollar is feared as a drain on the American gold supply, although the United States owns a major share of the free world's gold.

Faced with these difficulties, the Kentucky administration took several wise steps in 1961 and 1962 to protect the U.S. dollar.

In mid-1963, however, signs of an increased payments deficit and pressures from Western Europe on central bankers led the administration to impose monetary restraints on the domestic economy. The money supply was tightened, interest rates were raised and the discount rate, which the Federal Reserve System charges on loans to commercial banks, was increased from 3 to 3½ percent. This restrictive policy will have little, if any, impact on the payments deficit, but it places a damper on the faltering advance of the economy, at a time of high unemployment and large amounts of idle plants and machines.

In addition, the administration took two new steps in the right direction. For the first time, the United States has arranged to borrow \$500 million from the International Monetary Fund—to finance part of the payments deficit in a manner that will reduce the ability of foreigners to exchange dollars for gold at the U.S. Treasury. Secondly, the President has proposed an interest equalization tax on American purchases of new issues of foreign stocks and bonds, floated in U.S. money markets.

To date, however, America has not taken several essential, basic steps needed to solve the balance-of-payments difficulty.

The long-run solution to the U.S. payments difficulty requires two series of measures.

First, America must adopt expansionary policies to attain a growing, full-employment economy at home. Confidence in the American economy is a key to long-run strength at home and abroad. In addition, a prosperous domestic economy will provide increased opportunities for profitable investments. It will attract more foreign investments to the United States and reduce the attractiveness of investments in foreign countries to American investors.

Second, America must take the lead in working for the development of a new international monetary mechanism, with ability to expand credit—to ease world pressures on the dollar and to enable free world trade to grow. The establishment of such a new international banking arrangement will take time and American action in this direction is long overdue.

Meanwhile, however, short-term difficulties continue. For this purpose, America should adopt measures to remedy the specific difficulties that have arisen.

First, since the direct investment of American companies in foreign countries is a major factor in the balance-of-payments deficit, this issue should be met head on. Such investments result in an outflow of dollars—net outflows of \$1.6 billion in 1962 and a yearly rate of \$2.2 billion in the first quarter of 1963—and often also result in the loss of American jobs. While much of these investments may prove helpful in the long run, temporary curbs on such great outflows are preferable to restrictions on the domestic economy which result in unemployment at home.

It is essential that the United States adopt direct restrictions on investments of U.S. companies in industrial nations—with no controls on investments in developing countries. Most nations restrict foreign investments of their nationals. Such measures should be taken by the United States, limited to investments in industrial countries—to reduce this type of dollar outflow, so long as the payments difficulty continues.

Second, at the earliest opportunity, the United States should eliminate the 25 percent gold cover on its currency. Most other nations abandoned such gold covers long ago. There is no rational reason for the United States not to make all of its gold available for international transactions, if necessary.

Third, the United States should consider direct restrictions on the flotation of foreign securities in American money markets. Surely, the industrial nations of the free world have had ample time to develop their own capital markets for their own businessmen. Consideration should be given to limiting the freedom of foreigners to raise funds in American capital markets, which has re-

sulted in net outflows of \$1.2 billion in 1962 and a yearly rate of \$1.8 billion in the first quarter of 1963.

Fourth, the Government should reverse the money-tightening and interest-raising policy of the past few months, while continuing its other measures to remedy the payments difficulty.

Above all, America must not sacrifice the domestic economy and the welfare of American working people in dangerous and self-defeating attempts to solve the balance-of-payments problem. Neither must we permit ourselves to be panicked by grossly distorted accounts of payments deficits. Continued efforts to curb the economy and to hold down wage increases at home not only will worsen the difficulty, but will result in unfair treatment of the major segment of the American population. An all-out effort to strengthen the American economy—the key to America's strength at home and abroad—should begin at once.

Mr. GOLDFINGER. Thank you, sir.

Now, the basic issues raised by this committee so far are not really whether the tax cut should be negated or whether the balance-of-payments pressures require slowing down progress at home.

But the basic issue, it seems to me, is whether or not the Federal Reserve Act should be changed. A review of the past 10 years, of the impact of the tax cut, and of the constant inflation fears and concentration of the balance-of-payments difficulty—this review, it seems to me, clearly illustrates not only the great influence of the Federal Reserve but it also demonstrates the need to change the Federal Reserve System into a public instrument of public policy.

The Board of Governors and the Open Market Committee members influence the lives of everyone. Under present law, all of the Open Market Committee members are not even appointed by the President or by the Congress, much less elected by the people.

Members of the Board of Governors are appointed by the President but their terms of office are not coterminous with the Chief Executive's.

The actions of the Open Market Committee affect monetary policy but there are no formal relations between the Open Market Committee and the Treasury.

It is my view that the terms of office of the Board Chairman and Vice Chairman of the Federal Reserve should be coterminous with the President's and they should serve as Chairman and Vice Chairman at the will of the President.

Such a change, it seems to me, would assure a degree of basic harmony between the President and the chief officers of the Government's monetary authority.

The terms of office of the members of the Board of Governors of the Federal Reserve System, I think, should be reduced below the present excessively long 14-year period with overlapping and reduced terms of office. One term should expire about every 1 year or 2.

In connection with the composition of the Federal Reserve System, an issue which we in the AFL-CIO believe to be of great importance, due regard should be given to membership on the Board of Governors of competent people from the various economic groups in the American society including the trade union movement and consumers.

Such a change in the composition of the governing body of the Federal Reserve System is essential if the Federal Reserve is to become a truly public governmental institution broadly representative of the experiences and thinking of the major groups in American society.

It is my view that similar changes are necessary in the composition of the governing structure of the 12 district Federal Reserve banks. Similarly, I believe that the Federal Advisory Council should be replaced by an advisory committee or council which would be broadly representative of all aspects of the American economy.

Such measures, it seems to me, are essential to broaden the composition of the governing authorities and Advisory Council of the Federal Reserve System.

Until and unless such changes are adopted the Federal Reserve will be subject to the charge that it is mainly dominated by the thinking and experiences of bankers, big business, and monetary specialists.

A public institution, as important as this government agency, in my opinion, should be broadly representative of the major groups in American society.

Now, in line with those kinds of changes in the Federal Reserve System, the Federal Open Market Committee should be abolished and the current functions of the Open Market Committee should be transferred directly to the Board of Governors of the Federal Reserve.

That means that the determination of open market policies, rediscount rates and reserve requirements should be vested directly in the Federal Reserve Board of Governors, itself.

Moreover, formal relationships, I think, should be developed among the Federal Reserve System and such Departments of the Government as Treasury, Commerce, Labor, the Council of Economic Advisers and the Government's credit agencies, to assure a high degree of communication and coordination.

In addition, it should be a matter of public policy, including the policy of the Federal Reserve System, that the cost of money should be low enough and the money supply sufficiently ample to achieve and sustain maximum production, employment and purchasing power which are the goals set forth by the Employment Act of 1946.

Those who believe that such a general policy is inflationary have a view of inflation that is not in keeping with the productive potential of the American economy in the second half of the 20th century particularly with the spread of automation and rapidly rising productivity.

Those who seem perfectly able and willing to accept and continue the unique independent character of this Nation's central bank seem unable to accept the unique quality of American economic conditions in the 1960's and in the second half of the 20th century.

Constant fear of aggregate demand inflation was much more appropriate in another era when today's vast potentials of enormous production were impossible.

Inflation is not and has not been America's enemy in recent years. Rather our chief domestic handicaps have been slow economic growth, rising unemployment and underemployment. And we continue to lose billions of dollars of productive potential each year because there are those in positions who think in terms of an economy of scarcity and constantly fear inflationary threats when the real threat and the reality of the existing situation is one of underutilization of our manpower and of our productive capacity.

For example, right now it would take the addition of 3 to 4 million jobs to bring us to full employment in 1964. In addition,



through the rest of the 1960's the Labor Department expects the labor force to increase by approximately 1.4 million a year.

In order to reduce the present level of unemployment and underemployment and to provide job opportunities for the increasing size of the labor force, during the remainder of this decade, we need approximately an increase in employment of about 2 million each year. On top of that, we need increases in production and sales, increases in demand to offset the job displacing effects of rising productivity. We need new job opportunities of about 2 to 2.5 million each year to offset the job displacement effects of spreading automation and rising productivity.

In other words, each year during the 1960's through the remainder of this decade we need a vast increase in employment opportunities amounting to about 4 million to 4½ million a year, over 80,000 new job opportunities a week in order to bring us to full employment and to keep us there.

I, therefore, insist that the threat we face is a deflationary threat of tightening, rather than any reality of inflation in 1964 or in the near future, as far as we can see now—unless some new emergencies in the international situation should break out.

But in terms of the trend of the American economy and the present domestic situation our continuing major problem, our No. 1 problem, is the problem of unemployment and underemployment which is beginning to eat away at the fabric of American society. This must not be permitted to continue.

Changes in structure and composition of the Federal Reserve System would, in themselves, not change policies which, I think, must also be changed. But such changes in the structure and the composition of the Federal Reserve System would go a long way toward updating and modernizing national economic policymaking in the second half of the 20th century. Thank you.

The CHAIRMAN. Thank you, sir. Your statement, I think, is very fine. It will be very helpful to this committee.

Mr. REUSS, would you like to interrogate the gentleman?

Mr. REUSS. Thank you, Mr. Chairman.

I, too, want to congratulate you, Mr. Goldfinger, on the very searching analysis you have made of our money and interest rates and credit problems.

I want to base my question on the last few words that you spoke, just now, when you pointed out that these changes in the structure that you are advocating would not in and of themselves produce the changes in policy that you feel are necessary.

I am afraid you are right. The changes in structure that you advocate, which I find to be basically appealing, are that the Board chairman's term shall be coterminous with the President's.

Well, looking at the situation today, that would not have mattered much, since Mr. Martin has been reappointed by a Democratic President.

It is further suggested that the Federal Open Market Committee, as it is now constituted, be abolished and its functions transferred to the Board of Governors.

I happen to think of that as a necessary reform, too, but based on the record, the present Board of Governors would hardly have come

out any different in its specific applications of the open market policy than has the Open Market Committee.

And finally, you suggested as a matter of public policy that the Federal Reserve should so conduct itself as to comply with the objectives of the Employment Act of 1946, for maximum production and employment and purchasing power.

Well, they say that they are now observing those safeguards. I would be afraid that if one were to make these structural changes tomorrow things would go pretty much as they have during the last 10 years.

I now come to my question: Whether in addition to these structural reforms, there should not be some sort of a congressional directive to the Federal Reserve System which is more up to date than the 50-year-old directive about a flexible money supply and the needs of commerce and the seasons, and so on.

In short, what do you think of the suggestion made by various witnesses before this committee that Congress should attempt to construct a legislative mandate regarding further increases in the money supply?

Mr. GOLDFINGER. I agree with you that the statute under which the Fed operates should be updated and modernized. The Fed should be instructed to operate within the guides of the Employment Act of 1946, and, in so doing, to maintain an adequate money supply and relatively low enough rates of interest to encourage growth without inflation.

However, in terms of your earlier remarks, Congressman Reuss, I agree with you that most of the structural changes that we have been talking about here so far this morning would modernize and update economic policymaking and insofar as they go, I think that in itself it is a worthwhile goal.

However, there is the issue of the policy of the Fed, itself, which is at least of equal if not greater importance.

This, of course, is a problem of education. It is a problem in good part in terms of the political situation. I do think, however, that one of my suggestions could at least deal with part of the problem within the Federal Reserve System, the problem of policy. That is the importance of changing the composition of the Board of Governors, the Advisory Council, and of the governing authorities of the 12 district banks.

The reason I say this, sir, is I think that one of the serious difficulties within the Federal Reserve System, the System is essentially dominated by the thinking and the experiences of monetary technicians, bankers, and big business people.

Now, this is not, as I said in my opening remarks, said to impugn their motives or integrity or their honor. I believe that they are honorable men and they are men of integrity.

However, their thinking and experiences are highly limited certainly in terms of the employment, unemployment, productivity, automation problems that I tried to emphasize in my statement.

A change in the composition of the Federal Reserve System, to broaden its composition to include within the governing authorities and Advisory Council of the Federal Reserve System people from other walks of life, not merely from the banking community, not

merely from big business or monetary specialists, but also people representing a trade union viewpoint, or a consumer viewpoint—I think that this change in the composition of the Fed would bring into the Federal Reserve System voices, viewpoints, and experiences which are lacking within the Federal Reserve System today.

I would like to believe that the addition of such voices and experiences would at least begin to steer the Fed away from its constant preoccupation with an inflationary threat when there is no inflationary threat, its constant preoccupation with the balance-of-payments difficulty. It would affect the danger that the Fed is always ready, it seems to me, to sacrifice the level of domestic output, the level of domestic employment in order perhaps to reduce the balance-of-payments deficit by a couple of hundred million dollars.

Mr. REUSS. I take it that one of your difficulties with the present statute, regarding the composition of the Board of Governors of the Federal Reserve System, is that it mentions certain categories that should be excluded.

Mr. GOLDFINGER. Yes.

Mr. REUSS. I think they include the banking and finance industries and agriculture, but there is at least one group or our society which is conspicuously left out.

I may not have the exact statutory language right, but it is to that general effect.

Let me ask you this: One who wanted to broaden and make more representative the Federal Reserve Board would have, it seems to me, two choices open before him.

He could either add groups like labor and consumers to the statutory list of the groups that have to be recognized, or he could remove any special designation entirely and simply require that the members of the Federal Reserve Board of Governors should be men of the highest integrity whose total composition reflected a cross section of American life.

Would you be willing to agree with their one of those two approaches?

Mr. GOLDFINGER. I would lean in the direction of your second choice, that is to remove the direction of making occupational choices now in the present statute and to use some language along the lines of making the Board of Governors and the others of the Advisory Council, and the governing authorities of the 12 district banks, representative of the major groups in American society. That would be an attempt to make the entire Federal Reserve System truly a public system.

Perhaps because of the history of the past and also because of the history of the kinds of composition that we have had in the Federal Reserve System, I think I might like to see added "such as" and to spell out some of the groups that should be included within the composition of the Federal Reserve System.

But I would lean in the direction of your second suggestion.

Mr. REUSS. I am very happy to hear you say this, because it is my own view that if the fundamental criterion was the devotion to public service and the idea that the totality of the Board should include a broad spectrum of views, I think we would be better off than trying to get seven people, each one of whom represented a special interest, even though labor was one of those designated special interests.

I think that the business of superintending the Nation's monetary policy is too important to be entrusted to any one group, or any series of interest groups; that if we had a public interest criterion, this really would be the best arrangement.

And I gather that that is, in general, your view, too?

Mr. GOLDFINGER. As I said, I definitely lean in that direction. But I would like to see within the governing authorities and Advisory Council or Committee of the Fed people from different walks of life because I think that one very important problem is the concentration, within the governing authorities of the Federal Reserve System, of people whose thinking and experiences come from banking, big business and monetary specialists.

One of the problems we face is that there is very little emphasis on the unemployment and underemployment problem within the Federal Reserve System as far as I know.

On the other hand, there is constant emphasis on the danger of inflation and the danger of the balance-of-payments problem.

I think that a change in the composition to broaden the composition of the Federal Reserve System would bring in new viewpoints, new experiences and new types of thinking that should be in the governing authority of the monetary policymaking agency of the U.S. Government.

Mr. REUSS. To turn to a different subject, at several times in your presentation this morning you referred to the creation of money and the creation of credit. I wondered if you would spell out for me how you differentiate between those two?

I ask that because I would have thought that the same actions by the Federal Reserve were intended to do both jobs.

Mr. GOLDFINGER. I agree with you, sir. That was kind of a figure of speech, I am afraid.

Mr. REUSS. Everybody does this, I might add, and I am sometimes confused by it, but what you say reassures me.

Credit, that is a bank loan resulting in a bank deposit, is in and of itself money, is it not?

Mr. GOLDFINGER. Yes.

Mr. REUSS. Thank you, Mr. Chairman.

The CHAIRMAN. Mr. Goldfinger, this statement of yours is very fine. I want to reiterate that it brought out some wonderful points, some of which have not been expressed before. All are helpful.

I would like to summarize by mentioning the bills that we really have before us.

Now, we have before us H.R. 3783 which will, if enacted into law, permit the member banks, 6,000 member banks to get back their \$500 million capital investment in the Federal Reserve. That is what they have invested in the so-called stock of the Federal Reserve.

The testimony has disclosed that although it is called stock it is not stock at all. It cannot be voted. The bank that holds this so-called stock cannot sell it. A member bank's stock goes up and down according to the capital assets of the bank, that is, its capital surplus and undivided profits.

So, it is not really stock and we have built up a system here of 6,000 banks, most of them national banks, only about 1,000 State banks belong to the system, and all have been given special privileges.

This is something that we have never carefully considered.

Why should we give those 6,000 banks special privileges? They are contributing nothing special to the system. That money that they have invested involuntarily returns 6-percent interest, and Mr. Martin tells us we should not retire the stock because banks look upon that 6 percent as a great value.

So, if Mr. Martin is right, then instead of the banks doing something for the Federal Reserve and the Government it is just the opposite. If that is true why should we deny those other 7,000 banks the same privilege?

We should let them come in, too. They are part of the financial institutions that we must give consideration to and they are entitled to the same consideration.

Mr. GOLDFINGER. I agree with you, Mr. Chairman, that the stock problem in the Federal Reserve System should be taken care of.

In the first place there is the riskless nature of this investment under existing conditions, an assured return of about 6 percent to the banks.

But I think much more important than that is the symbolism involved in the stock ownership. This symbolism, I think, is very bad, to the extent that there is any reality to this symbolism, it becomes even worse; that is, private ownership of a public system, particularly a public system as important as the monetary-making authority of the U.S. Government.

I therefore agree with you that the present form of capital stock of the Federal Reserve banks should be retired. Furthermore, I think some method should be developed to make it compulsory for all commercial banks to be members of the Fed. The Fed should be truly a public system without this at least symbolic private ownership and riskless investment with a 6-percent return.

Mr. REUSS (presiding). In your suggestion made just now that all commercial banks be required to be members of the Fed, would you require actual Fed membership? Or would it satisfy you to require that their reserve-creating powers be subject to Fed regulation?

Mr. GOLDFINGER. Frankly, sir, I have not thought this through in that amount of detail.

I was suggesting merely that some method be devised to make compulsory membership within the system. It may be that your suggestion would be just as good because my particular goal is to extend the authority of the Federal Reserve over all commercial banks. If this can be done, along the lines of your suggestion, without compulsory membership, I think that would be just as well.

Mr. REUSS. Your main point, then, is that you think it is somewhat ironic that the Federal Reserve fidgets over the supply of money and credit when there are many thousands of credit-creating institutions or banking institutions over which there is no control under the present law?

Mr. GOLDFINGER. Yes.

Mr. REUSS. Mr. Chairman, Mr. Goldfinger's answer to the question which you asked him before you were called out was to support very vigorously the suggestion that the nominal stock ownership of the banking members of the Federal Reserve System be eliminated.

Mr. GOLDFINGER. I would like to add, sir, that there is or there seems to me to be a fantastic aspect to this stock ownership that

private banks own shares not only within a public system but also within a public regulatory system which regulates the owners. One of the functions of the Federal Reserve is to regulate the banks and yet the banks, through this stock ownership system, own shares, at least theoretically, within the Federal Reserve System.

There is far too close a relationship between the members and the regulatory agency.

I think that there would be great outcries from the Congress and from many people in the country if the National Labor Relations Board, for example, were to be owned through shares by the trade union organizations of this country.

The CHAIRMAN (presiding). The Constitution says that Congress shall coin money and regulate its value. This is one of the duties imposed upon Congress.

I think it was the right thing that the Constitution was written that way. The Supreme Court has held that to coin means to print too, as well. Like it is in the Constitution, if an administration in power had been elected to do certain things and Members of Congress had been elected to do certain things, the people have a way of making corrections if these things are not done or if the people are imposed upon.

But if we set aside congressional power over money and let the bankers run it, the people have no way of making corrections. The authorities have nothing to lose at all; they do not stand for election.

A person in politics has many reasons why he should do everything exactly right and try to represent the people in the way that they should be represented. But if somebody like the bankers have this area set off to themselves, where they can determine the volume of money, which they are doing right now in secret, and also the interest rates as you so well brought out in your statement (the people aren't represented). The bankers can veto anything that the President does through monetary policy.

They can veto anything that the Congress does through monetary policy. I know that was never intended by the Constitution of the United States. It just accidentally got away from the people.

Now, in 1913 when the Federal Reserve Act was passed we did not have any central bank. We just had 12 regional banks. Their powers were very limited. But these banks grew up and in 1922 they organized these unofficial committees known as Open Market Committees where they would use the assets of all 12 banks to operate in the Government bond market and then the time of the charter was about to expire.

You know the charter of the Federal Reserve banks was for 20 years. Just like the charters of the other two banks that actually were not renewed a hundred years ago. Now you know in 1913, the people who wanted bankers on the Board and did not get them on the Board fought the Federal Reserve. But later on when they organized these Open Market Committees that represent all 12 banks and have a lot to do with monetary policy these people became interested and they got that 20 years straightened out even without a discussion on the House floor and in the Senate.

And then in 1933 when we were at the depths of the depression and we were hoping to get out by every kind of a bill that was brought

up that said it would help us get out of the depression and so the Members would vote for it without much study and consideration, why then the bankers got the Open Market Committee approved.

And now we have this situation where every 3 weeks the Open Market Committee meets down here at the Federal Reserve Board. Seven members, of course, are appointed by the President for 14-year terms and confirmed by the Senate but there are 12 other members that meet with them. They are presidents of the Federal Reserve banks.

Now, those presidents of the Federal Reserve banks, they are elected by the private banks because every board of directors is composed of nine members, six selected by the private banks themselves, six out of the nine. They elect the presidents.

These presidents go right in this secret meeting down here every 3 weeks. They have more to do with our country and economic policies than the Congress or the President. They have more to do with our economy than anybody else in authority in the United States.

Yet, they meet in secret. They do not even want us to see their minutes of 5 years ago. They do not want anything known. They want to do it all secretly.

Well, of course, I personally think that is going too far. I think it is unconstitutional. I think it is wrong. They have had one depression after another and I think these depressions are manmade. They could have been avoided.

The Federal Reserve has the power to avoid them if they want to but they are so topheavy with banker influence, I do not think that they have been carrying out their real duties. I do not think that there is anything wrong with the Federal Reserve System that a board of good, dedicated public servants, selected by someone representing the people would not cure.

I think that that is all that is wrong with it. Of course, we might have to start from scratch. We might have to repeal the Federal Reserve System. They have gone clear out of their path of duty and responsibility.

They have 20,000 employees in these 12 banks and what are they doing? I asked the Reserve bank Presidents, when they were occupying the place that you are, each one of them, what important decision they made last year.

Their answers are rather amusing. Some of them could not even find an important decision except looking after personnel and things like that. They were telling the truth because the Federal Reserve has gone out of the business that it was organized for. Now they are just clearing checks. It was intended in the Federal Reserve Act, section 16, that the banks would pay for clearing the checks, but now the Government is doing it. It is costing the Government about \$125 million a year. We haven't had an audit so we don't know the exact amount. Maybe it is all right for the Government to pay for clearing checks. I am not saying it is wrong. We want to do what is best in the public interest of this country and for the people of this country, but at the same time that is their principal duty; just clearing checks.

Today, everything else is done in New York and concentrated there. New York is not mentioned in the Federal Reserve Act. New York is not mentioned in any of the debates except to say that we want to get the monetary matters away from New York and bring them back to Washington.

But instead of that we are giving more and more control to New York. The only business except check clearing that is done by the Federal Reserve System is done by the Federal Reserve Bank of New York. They do it all. The portfolio of the Open Market Committee is over there in New York. They have \$34 billion worth of Government bonds which they acquired just by the flick of a pen.

They did not pay anything for them. They just created the money to buy them and that is all. Nobody denies that.

Now, they draw over \$1 billion a year interest on those bonds. The taxpayers are still paying for them. They were paid for once by the Open Market Committee using money printed by the Bureau of Engraving.

Well, that does not make sense to me at all. Another thing that makes no sense is having exclusive bond dealers. We have to have dealers, at least dealers are necessary. But we do not have to have exclusive private dealers. In fact, the New York bank and the other 11 Reserve banks could be dealers in Government bonds to help the Open Market Committee or the Board to carry out its functions. But, instead, they have just selected 19 so-called qualified dealers over there, right around Wall Street, within a stone's throw of the New York Federal Reserve Bank, right there close, all on the same telephone line, right there together.

They are the dealers in Government bonds. They work with and through the Open Market Committee. They are exclusive dealers.

Every bond that is bought or sold by the Open Market Committee must go through one of those dealers. It is just like saying that the dealers have two tollgates. One gate, the bonds come into the Open Market Committee and they get a commission on them, and then on all bonds that are sold by the Open Market Committee there is another tollgate and they get a commission or a cut on that.

So, all bonds coming through the Federal Reserve System are handled by those same dealers. So, instead of getting the money matters in the hands of dedicated public servants it looks to me like it has finally resulted in just the people who can profit most from scarce money and high interest having too much control.

What do you say about that?

Mr. GOLDFINGER. Well, I most certainly agree with you, sir, the Federal Reserve System is much too much dominated by the kinds of interests and groups that you refer to.

In my statement, I quoted from the Commission on Money and Credit which was the Commission including some of the leading bankers of the United States—

The CHAIRMAN. Yes, I know.

Mr. GOLDFINGER (continuing). As well as people from other walks of life. This Commission stated—

what was thought of in 1913 as essentially a cooperative enterprise among bankers for the purpose of increasing the securities of banks and providing them with a reservoir of emergency resources has not ceased to be that, but it has also become one of the most potent institutions involved in national economic policy.

Certainly we in the AFL-CIO do not believe that the Nation's central bank should be a cooperative enterprise among bankers. The Commission on Money and Credit states just that—that is what it is and that is what it has been.



This Federal Reserve System should be a public system, a regular part of the U.S. Government.

The CHAIRMAN. I want to bring up one thing and then I will yield to Mr. Widnall if he would like to ask some questions.

Yesterday I received a copy of a paper that was published in York, Pa. The headline was, "City School Board Borrows \$1.25 Million in Investment Scheme To Gain Interest."

There are all kinds of schemes and gimmicks, you know, that are being devised all the time to make more money.

Naturally it would be for that purpose and I do not condemn all of them but some of them are just gimmicks against the public interest.

It says:

York city school directors last night authorized the borrowing of \$1,250,000, which will then be reinvested as a means of earning money for the school district.

Franklin W. Zarfoss, finance chairman of the school board, said the money will be borrowed from a lending institution. The funds then will be placed in time deposits which he said will bear interest at a rate higher than the rate of interest being paid to the bank by the district.

Zarfoss explained that this was possible because lending institutions do not pay taxes on interest earned from loans to school districts. Such earnings are not subject to Federal income, similar to the earning on municipal bonds, Zarfoss said.

Zarfoss was asked if this was not a situation in which the school district and the bank would profit at the expense of the Federal Government. He replied: "Are you more interested in the Federal Treasury or the local school district? I'm more interested in the district because I have more control over it."

Zarfoss did not identify the bank from which the money was to be borrowed, nor would he say what the actual interest rates will be.

He said that he could "guarantee that the city school district will not lose on this; it will gain."

Zarfoss said that there were no immediate obligations of the school board to be met by the \$1,250,000 loan.

The legality of the loan has been cleared by the State Department of Public Instruction and by the school board solicitor, K. F. Ralph Rochow, Zarfoss said.

Rochow said he approved the transaction as legal and conceded the way "it probably will work is that the bank can pay them more interest because the money it earns on the loan is tax free."

I will insert the whole article which explains it a little bit more.

(The article from the Gazette and Daily, York, Pa., dated March 20, 1964, referred to above follows:)

#### CITY SCHOOL BOARD BORROWS \$1.25 MILLION IN INVESTMENT SCHEME TO GAIN INTEREST

York City school directors last night authorized the borrowing of \$1,250,000, which will then be reinvested as a means of earning money for the school district.

Franklin W. Zarfoss, finance chairman of the school board, said the money will be borrowed from a lending institution. The funds then will be placed in time deposits which he said will bear interest at a rate higher than the rate of interest being paid to the bank by the district.

Zarfoss explained that this was possible because lending institutions do not pay taxes on interest earned from loans to school districts. Such earnings are not subject to Federal income, similar to the earning on municipal bonds, Zarfoss said.

Zarfoss was asked if this was not a situation in which the school district and the bank would profit at the expense of the Federal Government. He replied:

"Are you more interested in the Federal Treasury than in the treasury of the local school district? I'm more interested in the district because I have more control over it."

## "NO LOSS" GUARANTEED

Zarfoss did not identify the bank from which the money was to be borrowed, nor would he say what the actual interest rates will be.

He said that he could "guarantee that the city school district will not lose on this; it will gain."

Zarfoss said that there were no immediate obligations of the school board to be met by the \$1,250,000 loan.

The legality of the loan has been cleared by the State department of public instruction and by the school board solicitor, K. F. Ralph Rochow, Zarfoss said.

Rochow said he approved the transaction as legal and conceded the way "it probably will work is that the bank can pay them more interest because the money it earns on the loan is tax free."

The money was authorized for borrowing from now until June 30, the end of the school fiscal year, although the borrowing resolution authorizes the holding of the money as late as November 1.

"This is a trial balloon," Zarfoss said. "We feel it will stabilize the economy of the school district."

He said the specific purpose of the loan is "to give us better control over school district finances" and cut down on the number of loans that must be made in a given period."

## NO OBJECTIONS

Every member of the school board present last night voted in favor of the resolution to borrow the money, but one director, A. H. Thatcher, criticized the manner in which he was notified of the transaction. Only member not present was H. DeForest Hardinge.

Thatcher charged that when he arrived at the meeting and saw the loan item on the agenda he was surprised.

President John G. Bergdoll, Jr., said that he had asked Business Manager Charles S. Warner, Jr., to notify several members of the board of the loan by telephone.

"Charlie, didn't you call these people?" Bergdoll asked.

"A telephone call is some fine way to find out about a million and a quarter dollar loan," Thatcher fired back.

Democrat Thatcher continued:

"If one of my fine Republican friends were to ask me on the street, 'What in the world did you school board people borrow \$1,250,000 for?' I wouldn't know what to tell them."

Thatcher said he now understands the reason for the loan "and I heartily agree with it." He said, however, that Bergdoll should have called a special meeting to explain the purpose of the loan to the members.

"When we borrowed \$450,000 last week," said Thatcher, "we called a special meeting to do it. I would think that a million and a quarter dollar loan would be three times as important."

The school directors regularly caucus on the Thursday before their regular meeting. They interrupted that caucus last Thursday to hold a 5-minute special public meeting at which they authorized a loan of \$450,000 to meet current expenses.

Thatcher said that when the item came up for a vote, "I looked at the faces of Mr. (Willard A.) Saltzgeber, Mr. (J. Edward) Pawlick, and Mr. (Dale W.) Linebaugh, and from their expressions I knew that I was not alone" in being surprised.

"I apologize," said Bergdoll, a Republican, "we'll try to see that you are better informed." Saltzgeber is a Democrat, while Pawlick and Linebaugh are Republicans and newcomers to the board.

Thatcher stressed that his criticism was not to be construed as criticism of the loan, which he characterized as "an excellent move, for which the finance committee is to be congratulated."

Zarfoss said the loan proposition had been looked into carefully and was the result of negotiations between Bergdoll and Warner and representatives of several banks.

The CHAIRMAN. That brings up this point. Banks are allowed to create money which is all right if they create it in the public interest and use it in the public interest. I am all for it under that condition and that limitation but I certainly do not think that banks should

be allowed to create money on the credit of the Nation, unless it helps the people.

I think the No. 1 obligation of a bank in a certain locality or in any locality is to take care of the people in the area that they represent.

Originally they did that and it was wonderful. That is the reason we allowed them the privilege of creating \$10 on every dollar that they had. It is being done right now.

I do not object to that if they do it in the public interest but just to do it for speculation, to make more money, and not help the people, I think, is different.

Here we have all kinds of gimmicks that are based on the power to create money. I think for a bank to create money like they have a right to do and which we give them the right to do—only the commercial banks and the Federal Reserve can create or manufacture money—but for reserve requirements to be lowered or just forgotten so banks can create money to buy long-term Government bonds, I think, is absolutely wrong. It is absolutely wrong; but it has happened more than once. And then to create money to buy long-term tax-exempt bonds is bordering on immorality in my book.

Now, here is a case, a new gimmick. It is where they induce a school board—it could be this way or it could be a different way and it would be perfectly legal this way. The banker could say, "Now, Mr. School Board President, you borrow \$1,250,000 from us. You pay us 3 percent interest.

"Of course, we can accept 3 percent interest because it is tax exempt and that is the equivalent taxwise of about 4½ percent but you will only pay us 3 percent for that. You put the money over in time deposits, where we need only a 4-percent reserve against deposits, and we will pay you 4 percent interest for that time deposit that we created by lending you that very same \$1,250,000 time deposit."

Now, the money *never* leaves the bank. It is just created money right there on the books of the bank like they do all the time. And the net result is that the school district pays 3 percent, which is tax free which therefore earns the bank 4½ percent, and then the bank pays the school district 4 percent.

In other words, the bank is getting the equivalent of a benefit of about \$6,000 a year and the school district is getting a benefit of over \$12,000 a year and without doing anything on earth. It is just created money. And being assured the money won't be withdrawn, the bank can lend this money over and over, all told 25 times since reserves need be only 4 percent of time deposits. Have you heard of any gimmick like that before?

Mr. GOLDFINGER. Well, sir, the story from York, Pa., is new to me and your interpretation of it off-hand certainly sounds right.

I have not heard of that particular kind of gimmick but I have heard of some other gimmicks which have troubled us a good deal—that is, the use of tax-exempt municipal bonds to lure plants from one part of the country to another or from one State to another for the development of industrial areas.

We are developing a kind of industrial luring cannibalism in this country on the basis of such uses of tax-exempt municipal bonds.

Furthermore, I understand, sir, that it is a frequent practice, not merely to use the tax-exempt municipal bonds to lure a plant from

one State to another or from one part of the country to another and provide the company with rent-free buildings, for 99 years, but also, to grant that same company the purchase of those tax-exempt bonds. The company is thus lured not only on the basis of rent-free buildings for a longer period of time but also through the purchase of those tax-exempt municipal bonds on which they pay no Federal taxation.

It is my understanding, sir, that within the past week or so Congressman Reuss has introduced a bill to deal with this specific problem.

The CHAIRMAN. May I comment on that and then I will yield to Mr. Widnall?

We have a bill here to permit the banks to buy revenue bonds.

Back during the depression we had some unfortunate cases originating with banks buying revenue bonds. The result was that it was made unlawful.

Now, we have a bill here to reestablish that power and right for the banks, to let them again purchase revenue bonds but there is an amendment that will go into that bill if it passes this committee, and I feel sure the amendment will be adopted, that will prohibit, just exactly what you have said there, which in some instances have—that scheme has grown to great proportions.

And it runs into lots of money, tax-exempt money, too. And we will have an amendment that will prohibit that.

And we will also have an amendment that will make it a penal offense, a criminal offense, subject to fine and jail punishment and in some instances a felony, and a penitentiary offense for the banks to engage in any of the practices or activities that they engage in that caused the passage of this law.

So I think those two amendments will be very helpful in that direction and one definitely in the direction that you are talking about.

Mr. GOLDFINGER. We are certainly interested at a minimum in limiting and curbing these abuses of the tax-exempt municipal bonds.

I would like to comment on an earlier remark of yours, Mr. Chairman. That concerns the 19 dealers in Government securities in New York City, who act on behalf of the Open Market Committee.

Once again, as you indicated, this represents the peculiar private relationships that exist within the Federal Reserve System, which is a creation of the Congress and should be a public institution.

Now, I do not have an answer. I do not have a solution for this peculiar problem. But this private monopoly of 19 dealers operating on behalf of the Open Market Committee, it seems to me, is clearly wrong.

Something should be developed. I am sure that something can be developed to change that system and broaden it, so that we do not continue to have the operations of the Open Market Committee or, if the Open Market Committee were abolished, the open market operations of the Board of Governors operating through a special selected group of 19 dealers in New York City.

Furthermore, it is my understanding that out of the 19 perhaps only a half a dozen are the major dealers, so that the selectivity here and the monopoly aspect here is even greater than it would seem at first.

The CHAIRMAN. Yes, sir. Mr. Widnall?

Mr. WIDNALL. Thank you, Mr. Chairman.

Mr. Goldfinger, I am just interested in this monopoly of 19 dealers that you speak of.

Mr. GOLDFINGER. Yes.

Mr. WIDNALL. How many other dealers are there in the United States?

Mr. GOLDFINGER. Offhand, I do not know, sir, but I—

Mr. WIDNALL. Well, how can you be so critical of the use of 19 if you do not know how many dealers there are?

Mr. GOLDFINGER. It is not only that there are 19 dealers but also that there are 19 private dealers, exclusive selected dealers.

Since the Federal Reserve System is a creation of the Congress, and is, or should be, a public system, some other method of operation of the Open Market Committee for the purchase and sale of Government securities could be developed.

As I said, Mr. Widnall, I do not have the solution to this problem, but I think it is a problem. It is in line with quite a number of other problems concerning the Federal Reserve System.

Mr. WIDNALL. As I understand it, Mr. Goldfinger, in addition to these 19 dealers there are 6 dealer banks and these are the only institutions or the only dealers that deal exclusively in Government securities and are able to handle this type of transaction.

Now, do you know of any others who are able to handle and who would like to handle this and have been cut out of this?

Mr. GOLDFINGER. Well, it may be, sir, that within the existing circumstances and within existing conditions that these are the dealers who can handle it.

But I do not think that this need be forever the case. I think that we should develop some other method, an alternative method, which would broaden the base of operations of the Open Market Committee perhaps through the 12 district Reserve banks operating in order to broaden the entire base of the Federal Reserve System.

One of the attendant difficulties is that the 19 dealers, in turn, only deal essentially with multimillionaires and big commercial banks. They do not deal with the broad middle class and even upper middle class public. I think that the purchases and sales of Government securities should be broadened out at least to reach that part of the public which wishes to purchase Government securities.

The CHAIRMAN. Mr. Widnall, will you yield for what I believe is a correction?

Mr. WIDNALL. All right.

The CHAIRMAN. I think the 6 banks are a part of the 19.

Mr. GOLDFINGER. Yes.

The CHAIRMAN. I feel reasonably certain of that. And a number of dealers have tried to get in but they have been refused.

Mr. WIDNALL. I am told that anyone having enough capital can qualify as a dealer if he makes the market. These 19 are the only ones who can take the risks because of the small markets involved.

Now, do you have any comment on that?

Mr. GOLDFINGER. As I say, sir, that may well be the case under existing conditions, but I do not think that these existing conditions are good.

I think we can change the conditions here; perhaps the 12 Reserve banks can operate in this area; perhaps some new mechanism can be developed.

I repeat, I do not have the solution for this problem, but I think that it is something which should be examined because it is part and parcel of the entire problem of the operations of the Federal Reserve System.

Mr. WIDNALL. Well, I would certainly think that you would admit that we have to deal with what exists and if there are 19 dealers that exist we have to deal with them.

We cannot deal with 28, if there are not 9 others.

Mr. GOLDFINGER. Yes, but the Federal Reserve System has been in existence since 1913. That is 50 years.

We have had time, experience, and precedents. There are other kinds of central banks in other countries of the world.

I think that we can develop a different kind of system, of operations for the open market.

Mr. WIDNALL. Mr. Goldfinger, you said, on page 13, "Inflation has not been a factor in recent years"—

Mr. GOLDFINGER. That is right.

Mr. WIDNALL (continuing). And you also criticized the policy of the Federal Reserve System as being restrictive.

Mr. GOLDFINGER. Yes.

Mr. WIDNALL. Now, might not inflation have been quite a factor, as it has been in the past, if the Feds' policies had been different?

Mr. GOLDFINGER. Not necessarily, sir, because the problem that we have faced in the United States, since 1953, is a problem of a rising trend of unemployment.

In the year of 1953 there were 1,900,000 unemployed. In 1963, 10 years later, unemployment rose to 4,200,000.

Another way of measuring it is that in 1953 2.9 percent of the labor force was unemployed. In 1963, 5.7 percent of the labor force was unemployed.

I submit, as I suggested in the statement, that the actions of the Federal Reserve System contributed to the rising trend of unemployment.

I do not believe that within the past 10 years there has been a problem of aggregate demand inflation. The monetary policy of the Federal Reserve in tightening money operates on demand inflation.

To the extent that the Federal Reserve tightens money and increases interest rates it has an effect upon the entire economy, upon the entire level of demands.

It is my view that the monetary policy of the government—not alone, not solely the monetary policy—was one contributing factor, among several others, to this problem of a continued rising trend of unemployment. I might add, it also affected underutilization of productive capacity. In the past 10 years, if you look at the record of the McGraw-Hill surveys, which are generally used by economists and businessmen, you will find that in terms of productive capacity only for a few months, at the end of 1955 and early 1956, did we even approach an appreciable level of industrial operations in the United States.

All through the past 10 years we have had, first, a rising trend of unemployment and underemployment. Secondly, we have had a continuation of a considerable amount of idle productive capacity except for those few months at the end of 1955 and early 1956.

Mr. WIDNALL. Well, prior to 1953, we had an inflation in very large doses.

Now, does inflation benefit the wage earner—

Mr. GOLDFINGER. No, sir.

Mr. WIDNALL. Those with the fixed incomes and those on the retired lists?

Mr. GOLDFINGER. No, sir. I believe that if and when we have aggregate demand inflation, when we see the whites of the eyes of such inflation, then is the proper time to move against such inflation. The labor movement is on record as advocating such anti-inflationary policies. Back in 1951, the AFL and the CIO jointly adopted an anti-inflationary policy declaration asking the Federal Reserve System and the monetary authorities to engage in such policies as increasing reserve requirements to sop up the liquidity at that time.

However, if you look at the postwar period you will see that we have had two brief periods of demand inflation. We had a period of demand inflation right after the end of the war. This petered out by 1948, as productive capacity increased, as business investments increased the amount of money in plants and equipment.

Then we had another brief period for approximately a year or so after the outbreak of the Korean war when there was a war scare, excessive hoarding, excessive buying, and so on, but I believe firmly since 1951 or the middle of 1952, we have not had any reality of demand inflation in the United States.

The difficulty is that the Federal Reserve System has misinterpreted events in the economy, that it harps on inflation when there is no inflation and, therefore, it adopts restrictive policies to restrict the economy and create underutilization of planned equipment and manpower.

As far as I am concerned, the No. 1 problem in America today is the problem of unemployment and underemployment.

Mr. WIDNALL. When William McChesney Martin was reappointed to the Federal Reserve Board and when Mr. Daane and Mr. Mitchell were appointed by President Kennedy, did the AFL-CIO protest their appointments?

Mr. GOLDFINGER. No, we did not, sir.

Mr. WIDNALL. Did you see the testimony of Mr. Daane and Mr. Mitchell, who were appointed by President Kennedy, before this committee and which they supported the views of the Federal Reserve Board?

Mr. GOLDFINGER. I am not supporting all of the actions of President Kennedy or of President Johnson or of the Council of Economic Advisers or of the Treasury Department in this regard.

As I said in the earlier part when I summarized my statement, sir, I believe that there is a problem in the structure and the composition of the Federal Reserve System. I also believe there is a serious problem in the policy of the Federal Reserve System.

The problem concerning the policy of the Federal Reserve System is not located only within the Fed but it is also located elsewhere within the administrative agencies of Government.

Mr. WIDNALL. Well, what interests me is this—the criticism is made that there is no contact between the President and the Federal Reserve, and that they are operating in secret behind closed doors, and nobody knows what is going on all of this time, and that there has got

to be better balance all the way through. And yet, a President of the United States, whether he be a Republican or a Democrat, appoints new members to that Federal Reserve Board after hearing all of this criticism, and they evidently seem quite well satisfied with the operation as it is, and there seems to be disclosure and contacts and cooperation and effort that is going in the same direction as between the Executive and the Federal Reserve System.

So I do not understand the basis for the criticism.

Mr. GOLDFINGER. There have been many times in the past, as you undoubtedly know probably better than I do, when the President of the United States and the Federal Reserve System were at odds.

This happened during the term of office of President Eisenhower on at least one occasion and probably more often than that.

However, it is true that there are informal relationships between Chairman Martin and the Secretary of the Treasury. There are informal relationships between members of the Board of Governors of the Federal Reserve System and the administrative agencies of Government.

What I am suggesting here is that these informal relationships are not good enough. We should not have to depend upon friendly, social, informal relationships between two, three, or five people in high places in the U.S. Government.

I think that we should have a formal relationship established here. Such a relationship would eliminate some of the problems that continue to crop up at various points in time.

Furthermore, I would like to defend the Federal Reserve System. I would like to defend the continuation of a Federal Reserve System as the central bank of the United States. In order for me, and people like me, to defend this Federal Reserve System as the central bank in the United States, I think that we have to change the structure of the Federal Reserve to bring it completely within the folds of the U.S. Government. We must also change the composition of the Fed, so that its composition is more broadly representative of all groups in American society.

Mr. WIDNALL. You believe then that the Federal Reserve System should come under the appropriation process of the Government?

Mr. GOLDFINGER. On that one I don't have a hard and fast view, sir.

I do believe—

Mr. WIDNALL. Well, I think it is extremely important, Mr. Goldfinger, because if they are coming under the executive head completely I think it would naturally follow that you would have to go get annual appropriations for the operation of the Federal Reserve System, and I know the Congress, and I know what happens with respect to appropriation moneys, and it seems to me that this would be tampering with the monetary system in a way that the country could ill afford if we ever attempted to do that.

Mr. GOLDFINGER. Well, you may well be right. If it is for that reason then I am not sure that I would go as far as the alternative that you suggested.

However, I see nothing wrong in the GAO making an annual audit of the Federal Reserve System.



And I certainly see nothing wrong in hearings such as these and others which your distinguished chairman has participated in over the years, to call upon the Federal Reserve to explain its policies and role and actions.

Mr. WIDNALL. I have no quarrel at all with that. I do not think any member of this committee has any real quarrel with evaluating the work of the Federal Reserve System and having an inquiry such as we have been having.

But I do think that it should be more than just having change for change's sake, and it seems to me that a lot more of that is inherent in your testimony.

Mr. GOLDFINGER. The Commission on Money and Credit was a Commission which included a number of leading bankers of the United States—bankers such as David Rockefeller, Mr. Schwulst, of the Bowery Savings Bank in New York, Marriner Eccles, former Chairman of the Board of Governors—as well as other people, including two trade union representatives.

The Commission on Money and Credit adopted a large number of proposals, some of which I do not believe went far enough, but they adopted a large number of proposals along the lines suggested in my statement here.

They suggested changes in the structure and in the composition of the Federal Reserve System, not merely for change for its own sake, but because such changes are necessary to update and to modernize the Federal Reserve System in the second half of the 20th century.

Mr. WIDNALL. Do you feel that there is a shortage of credit today?

Mr. GOLDFINGER. I do not believe that there is a shortage of liquidity today. However, on the basis of past experience in the past decade, I seriously fear that the Federal Reserve System may tighten up during the course of the year 1964 to offset all or part of the economic stimulus of the tax cut.

This, I think, would be very bad.

Mr. WIDNALL. Well now, addressing ourselves to action by other countries rather than the United States, suppose corrective action is taken in the other countries. Suppose England goes from 5 percent to 6 percent, and the other countries also tighten up.

Do you feel that the Federal Reserve system has to take cognizance of this—

Mr. GOLDFINGER. Yes.

Mr. WIDNALL. Wouldn't they have to take some action here if this happened, corrective action?

Mr. GOLDFINGER. No; I do not believe that necessarily the Federal Reserve would have to take corrective action here.

I do not believe that the domestic policies of the United States should be determined by what the Bank of England or the Bank of France or the Central Bank of Germany do.

I believe that the major responsibility of the Federal Reserve System, as the central bank of the United States, should be along the lines of the Employment Act of 1946, that is, to promote maximum employment production and purchasing power, and I think that the major responsibility is here.

Now, furthermore, I do fear the Fed doing what you suggest. I fear that in response to some deflationary actions taken by the central

banks of Western Europe, and out of fear of balance-of-payments difficulties, the Fed may so tighten up, within the United States as to offset all or part of the economic stimulus of the tax cut, with the result of a persistent high level of unemployment and idle productive capacity.

It is unemployment—

Mr. WIDNALL. We have now a persistent high level of unemployment, do we not?

Mr. GOLDFINGER. We do.

Mr. WIDNALL. And have had for some time?

Mr. GOLDFINGER. Part of the reason for that is the operations of the Federal Reserve System, in my opinion.

In other words, had the Federal Reserve System operated on a more expansionary policy during the past 10 years, I do not believe that we would have this high level of unemployment, and under utilized capacity.

Mr. WIDNALL. What I had in mind, when I was speaking about the countries overseas, was the prospective flow of funds from the United States overseas if nothing is done over here.

And this would end up—I should think it would end up with a tightness of credit here in the United States, inflationary pressures, and certainly a net loss to the employed here in the United States.

Mr. GOLDFINGER. I cannot set up hard and fast rules because I do believe that the Federal Reserve System has to be flexible in its policies, but I would set up these kinds of guidelines:

First and above all, I do not believe that the monetary policy of the United States should be determined by what the central banks of Western Europe or any other part of the world do—

Mr. WIDNALL. Well, Mr. Goldfinger, I agree with you on that, but they certainly have to be mindful of what is going on in the rest of the world—

Mr. GOLDFINGER. Oh, of course.

Mr. WIDNALL (continuing). Because we are involved right now in a trade war or trade discussions or anything you want to call it, where we have some very vital stakes.

As far as our economy is concerned, if we get out of balance with the rest of the world we are in trouble.

Mr. GOLDFINGER. I fully agree with you, sir, but I do not think that we should sacrifice tens of billions of dollars of lost production here at home, that we should sacrifice millions of unemployed and under-employed people here at home in order to protect against the outflow of maybe \$500 million or so of hot money on a temporary basis.

Furthermore, I think that the soundest basis for getting at the problem of the balance of payments is a healthy growing economy at home with bolstered confidence in the American economy, and the U.S. dollar, and with private investment opportunities growing here so that money will stay at home. I think that one of the problems, in terms of outflow of private capital, in recent years has been precisely the doldrums of the American economy, and the lack of sufficient private, profitable investment opportunities here at home because of the continuing problem of under-utilized capacity.

Mr. WIDNALL. Well, Mr. Goldfinger, is it not true that we are not given the privilege of looking at both sides of the coin when we now,

in retrospect, look back and try to appraise the results of policy without the benefit of knowing exactly what the conditions were at the time that they made those decisions 10 years back or 11 years ago or 5 years ago?

Mr. GOLDFINGER. Well, in part, I would certainly agree with you.

I would not want to be a carping critic of the Fed.

The Board of Governors, in the past 10 years, have faced very serious problems and they have come up with certain kinds of answers. I think that their answers frequently were wrong.

And I think that they were frequently wrong in part because of the peculiar composition of the Fed, not because they are dishonorable people or people without integrity, but because of the experience and thinking that dominates the governing authorities of the Federal Reserve System.

I think it would have been very helpful within the Federal Reserve System if there had been somebody on the Board of Governors who was mainly concerned with the problems of unemployment and underemployment and underutilized capacity.

In other words, there would have been other possibilities if there had been other viewpoints within the Fed, in addition to those of the bankers, big businessmen, and monetary specialists.

Mr. WIDNALL. Mr. Goldfinger, in our attack on unemployment, and I am sure that all of us regardless of political background want to see unemployment cut down to the point where we have employed as many as possible, so much has been said of the restrictive influence of high-interest rates.

Do you not think that most of the young people and the elderly could be helped by the elimination of some of the restrictive laws with respect to their employment?

I am thinking in particular in connection with some of the older people that we are so concerned with now, because they cannot pay their medical bills and other things like that and, yet, they are restricted on the amount of money that they can earn and still keep their social security.

Mr. GOLDFINGER. Yes?

Mr. WIDNALL. Are you in favor of upping the amount of that exemption?

Mr. GOLDFINGER. Well, I would be willing to consider that as a very serious proposal—

Mr. WIDNALL. I know thousands and thousands of elderly who would love to work and cannot get jobs.

Mr. GOLDFINGER. If that were to happen right now all we would be doing would be playing musical chairs among the unemployed.

You might get a few jobs for some of the elderly, who would be displacing some of the younger people. The problem in the American economy today, and has been in recent years, is the lack of sufficient job opportunities. The first thing we have to do is to create enough job opportunities.

Mr. WIDNALL. Well, are there not other factors, too? For one, that the veterans are replacing the young people?

There are also some restrictive union practices that prevent employment of young people and some of the laws with respect to age are involved. There are a lot of people who are dropouts of school who

could get employment except that the State laws prohibit it at that particular age.

Another thing with respect to young people is that, in seeking employment, potential employers ask their draft status. They do not want to hire somebody who is going to have to leave in 6 or 8 months or a year to go into the draft.

And I certainly think that some changes could be made there so that there could be some guarantee to the stability of the young man if he gets the employment—

Mr. GOLDFINGER. Some changes in the draft status probably could be developed. I do not know what kinds could be developed to take care of the problems that exist, and I am sure it is a problem for some young men.

However, I would be opposed to dropping the age limitations on work in the States. I think that the problem in an automated economy, such as ours, with a continuing technological revolution, is to get younger people more education and more vocational training, so that when they do come into the labor market they will have the skills and education and training to compete for the jobs that exist. I would hope that the job opportunities would exist.

I would be in favor of the kind of approach that Secretary of Labor Wirtz has been talking about, to increase the age of those in school rather than to reduce it, because I think that there is a real problem in terms of the education levels of many of our young people in relation to the technological revolution we are living through.

Mr. WIDNALL. I sometimes think, when I contemplate some of the bills that are pending before the Congress now and the tremendous amounts involved per person, in order to try to give some education to these people, some stability to them, we would be much better off subsidizing one parent to stay home and make a home for the kids than to allow both parents to go out and work and leave them loose on the streets, the way they are today.

It would be a lot cheaper for the United States to handle it that way than go through an \$8,000 per person job subsidy, trying to reeducate them.

They are out on the streets because there is no stability at home, and we are not doing anything about that at all.

Mr. GOLDFINGER. I would suggest, not facetiously, sir, that we could do some of the things that you are talking about by extending the coverage of the minimum wage law to those who are not protected by the law, a bill—

Mr. WIDNALL. This does not take care of the unemployed—

Mr. GOLDFINGER. But, you see, you are talking about home stability and the reasons for women working. I am suggesting that one of the reasons is that there are roughly 12 million people in the United States working for less than \$1.50 an hour.

Now, that is \$60 a week or \$3,000 a year or less. Now, this undoubtedly is one of the problems relating to youth.

Mr. WIDNALL. I understand that.

That is all, Mr. Chairman—oh, Mr. Chairman, I do have one more question.

Mr. Goldfinger, is it not true that the minimum wage law excludes from the job market those who are subnormal workers. They cannot

get jobs if they are subnormal, if people have to pay them \$2 an hour?  
 Mr. GOLDFINGER. I do not understand what you mean by "sub-normal."

Mr. WIDNALL. Retarded, retarded.

Mr. GOLDFINGER. Well, we are not talking about retard people—

Mr. WIDNALL. Uneducated.

Mr. GOLDFINGER. We are talking about people who are working in motels, hotels, restaurants, who are working at miserably low wages, and I suggest that this is a serious problem.

It is a problem related to poverty. It is a problem related to the incomes of families and to the kinds of instability at home that you suggested exists, and I agree with you. I think we have it.

Mr. WIDNALL. We have this problem in connection with many of the Puerto Rican workers here in the United States talking jobs at low rates, low wages, and the very minimum wages, and these people are having their problems. In Puerto Rico Spanish is still the primary language and, unfortunately, or, I should say, you are fortunate if you can get English taught down there in the schools.

Now, here is a Government-subsidized Commonwealth with an income tax situation the like of which we do not have, and all kinds of runaway firms going down to Puerto Rico. Then we end up with people who do not have any kind of a basic English education coming here.

Now, these people are naturally going to be limited in the opportunities that they are going to have because they cannot communicate.

It seems to me that we could go back and start right down in that little island and help some of the people, but I do not hear anybody suggesting that English should be taught as a primary matter in Puerto Rico.

We are all worried about the end result, but they do not come up with the authority to communicate.

Mr. GOLDFINGER. Well, I do not know about the educational situation in Puerto Rico. You may be right.

And if it is right I think they should speak English in the schools of Puerto Rico. I have been under the impression that they did.

Mr. WIDNALL. As a secondary matter.

Mr. GOLDFINGER. However, I want to assure you that the problem of low wages in the United States is not a problem solely of Puerto Rican or Negro workers, but of all kinds of workers. It is a problem which exists in the North as well as in the South.

It is a problem of low wages in large sections of American business enterprises, such as in hotels, motels, restaurants, and various kinds of services which are excluded from coverage under the Fair Labor Standards Act.

Mr. WIDNALL. That is all. Thank you.

The CHAIRMAN. To identify the paper that the item that I mentioned before came from, it is the Gazette & Daily, York, Pa., Friday morning, March 20, 1954, on page 1.

I would like to comment on what Mr. Widnall brought out about it would be against the interest of the monetary authorities for Congress to make the appropriations.

Congress makes appropriations for the Defense Department involving secrets of our Government, the atomic bomb, the hydrogen bomb,

the cobalt bomb, and all the rest, and that has never been a problem heretofore.

Congress has always been able to make their appropriations regardless.

In this case we have an unusual situation.

The Federal Reserve Banks have used our currency, Federal Reserve notes, which is a form of Government obligation. The Federal Reserve banks cannot issue currency. They must issue the Government's currency.

They have Federal Reserve notes, but they are not the obligation of the Federal Reserve banks, they are the obligation of the U.S. Government.

They say that the United States will pay the bearer on demand so many dollars.

Now, the Federal Reserve has taken this printed money that does not draw interest. It circulates, of course, as money circulates, without interest, but they buy Government bonds with it. They have bought \$34 billion worth that way.

Now, that really was trading one Government obligation for another. You would expect that \$34 billion bond obligation to go out of existence, because we have paid for it once with these note obligations. But, instead of the bonds being canceled or the national debt being reduced that much, why, they just keep that \$34 billion in the New York Federal Reserve Bank, and they call in the Treasury, the taxpayers' money, to pay the interest every year, and they get over \$1 billion a year interest and they just use that interest to pay their expenses, any kind of an expense they want to.

They do not seem to have any ceiling on their expenses or any limitations or conclusions, and they spend that \$200 million of that \$1 billion a year, and the rest of it goes back over to the Treasury.

It is not all spent by the Federal Reserve, because the difference goes back into the Treasury. So that it is the worst form of back-door spending.

Congress has not authorized that. Congress does not look over the books of the Federal Reserve to see what they are spending it for.

Yet, it is Uncle Sam's money that they are spending—the taxpayers' money. I cannot conceive of any other form of back-door spending that would be more repulsive to the average citizen than that particular form, because it is just Uncle Sam, in effect, pinching his pocket-book with a \$1 billion gift to the Federal Reserve every year, and he says to the Federal Reserve Chairman:

You spend all of this you want to.

We are not going to tell you how to spend it. We are not going to look at your books. You do not make any report to us, but after you spend all you want to you send the rest of it back.

If that is not the worst form of back-door spending I cannot conceive of one that is worse. Yet, the very people who are against back-door spending are perfectly willing for the Federal Reserve to continue that and to collect their bits from a debt that has been paid once, but I will not go into this any further.

You have been here a long time, and we appreciate it and we appreciate your testimony.

Do you have any more questions, Mr. Widnall?

Mr. WIDNALL. No.

The CHAIRMAN. Before we close, I would like to say this:

Mr. Kilburn brought up the matter of certain correspondence between him and me, on the subject of the Federal Reserve and these current hearings. He brought it up in the course of the hearings on the IDA 2 days ago.

Inasmuch as this correspondence has no bearing on that bill and would, I am afraid, confuse the issue, and inasmuch as Mr. Kilburn insists on keeping his remarks on the record and will not delete them as not having any bearing on the IDA issue, I feel compelled to place the correspondence in the public record. Since the correspondence relates to the Federal Reserve investigation, without objection I am going to place it in the record at this point, and the record of the IDA hearings will show a cross-reference to this entry.

(The correspondence referred to follows:)

CONGRESS OF THE UNITED STATES,  
HOUSE OF REPRESENTATIVES,  
*Washington, D.C., March 5, 1964.*

HON. WRIGHT PATMAN,  
*Chairman, Committee on Banking and Currency,  
House of Representatives,  
Washington, D.C.*

DEAR MR. CHAIRMAN: I respectfully request that you call an executive session of the full Banking and Currency Committee to clarify and take such action as the committee may deem appropriate with respect to the issuance of subpoenas and circulation of questionnaires in the conduct of business of the committee or any of its subcommittees.

Sincerely,

CLARENCE E. KILBURN.

CONGRESS OF THE UNITED STATES,  
HOUSE OF REPRESENTATIVES,  
*Washington, D.C., March 13, 1964.*

HON. WRIGHT PATMAN,  
*Chairman, Committee on Banking and Currency,  
House of Representatives, Washington, D.C.*

DEAR MR. CHAIRMAN: On February 20, 1964, I wrote you a letter requesting to see a copy of the minutes of the executive sessions of our committee having to do with the issuance of subpoenas. Under the rules of the House, any member of the committee is entitled to see these minutes. In reply to that letter you said you would be glad to talk with me. This isn't a satisfactory answer. Since that date you have been breaking the rules of the House in keeping these minutes in your possession and not letting me see them.

I sent you a letter on March 5, 1964, copy of which I am enclosing. That was 8 days ago. You have not given me the courtesy of a reply.

I again request that you call an executive session of the full Banking and Currency Committee to clarify our rules on the issuance of subpoenas and the sending out of questionnaires. This has been done by you alone without the knowledge of the other members of the committee.

The rules of the House provide a rather cumbersome solution to this matter which, as you know, involves a petition by a majority of the committee to force a special meeting.

This whole matter, in my judgment, is being handled by you in an arbitrary manner. How you can be reluctant to have the members work their will on the rules of the committee is beyond me. The members of the committee have rights as well as the chairman. I do not see why every member shouldn't have a voice in the operation of the committee.

I am sending a copy of this letter, together with a copy of my letter to you of March 5, to all the members of the committee.

Very truly yours,

CLARENCE E. KILBURN.

CONGRESS OF THE UNITED STATES,  
HOUSE OF REPRESENTATIVES,  
Washington, D.C., March 14, 1964.

HON. CLARENCE E. KILBURN,  
*U.S. House of Representatives, Washington, D.C.*

DEAR CLARENCE: This refers to your letter of March 13 which was received late yesterday afternoon.

I note that you again request a meeting of the whole Committee on Banking and Currency to pass on the question of my sending out questionnaires and subpoenas. You fail, however, to indicate how I am violating any rule concerning the questionnaires or the use of subpoenas. Therefore, in order for me to properly consider your request, I would like for you to submit any instance where I have violated the rules concerning questionnaires or subpoena power.

Your conduct, Clarence, clearly indicates that you are opposed to any investigation of the Federal Reserve System or any investigation of practices of commercial banks, despite the fact that the Federal Reserve System has been operating 50 years without audit by the General Accounting Office or other independent auditors while handling many, many billions of dollars of the Government's money and credit annually. It is hard to believe that this situation has existed in our country, but it has, and yet you object to looking into the affairs of the Federal Reserve System.

I repeat, you have demonstrated hostility to any investigation of the Federal Reserve System and to any effort that would reveal undesirable banking practices by banks. This is supported first by your testimony before the House Administration Committee wherein you expressed opposition to our receiving adequate funds for an investigation of such matters and other matters serving the public interest.

Second, you persuaded the minority members of the committee to issue a statement the first day of the hearings on the Federal Reserve, January 21, 1964, denouncing the proposed investigation.

Third, while we were conducting a proper investigation of Federal Reserve practices, you described our committee as a "laughingstock"; and

Fourth, although you are not a voting member of the Subcommittee on Domestic Finance that is conducting the investigation, you do have the privilege to attend meetings and hearings. Yet, your attendance has been spasmodic and definitely uncooperative. This has been tolerated longer than it should have been because of your long service and the fact that you are the ranking minority member of the committee.

Our Subcommittee on Domestic Finance has the power to fix appropriate rules to conduct these investigations, which it has done. It is certainly unreasonable to ask that the whole committee be called together now for the purpose of trying to change the rules of the subcommittee in the middle of the investigation, particularly since proper procedure has been followed by the subcommittee in every respect.

Our committee has disclosed information sufficient to convince any reasonable, patriotic, unselfish person that if, during the last 50 years, the Federal Reserve had been as alert and solicitous of the interest and welfare of the people as it has been of the private commercial banks, our country might not have any national debt today. Instead, it owes over \$300 billion, with an \$11 billion annual interest charge on Government bonds, a large part of it constituting unearned interest.

Furthermore, if, during the past 17 years, the Federal Reserve had been working and operating in the interest of all of the people instead of a privileged few, our national debt today would be at least \$40 billion less than the present national debt. The interest on this \$40 billion is \$1.6 billion annually.

It is apparent that you are trying to turn the Presidents of the Federal Reserve banks into an unholy alliance to resist our investigations. Yet, none of these public officials have complained to me about the investigations.

In the recent past, I sent letters to each President of the 12 Federal Reserve banks for the purpose of obtaining information on a confidential basis. Such information was to be held by me as chairman, not for the purpose of publication, but for the purpose of acquainting the subcommittee with the information at the proper time in executive session. You evidently obtained one or more of these letters from the Presidents of the banks and proceeded to make the information public, without consulting with me. Consultation would have given me the opportunity to convince you that the letters were perfectly proper and would serve the public interest.



Our investigation has highlighted many important facts in the public interest, including the private meetings of the Open Market Committee every 3 weeks. This committee, which is top heavy with representatives of the private banks who could profit most from monetary controls and particularly high interest rates, has refused to permit the executive branch or the legislative branch to know anything about its proceedings.

The Open Market Committee is openly and flagrantly operating in violation of law, but in a way that permits sophisticated bankers and speculators to take advantage of what happens, and line their pockets with gold at the expense of the people.

We have information about the concentration of commercial banking institutions in our country that should be carefully investigated and exposed in the public interest. It is apparent that a few wise men in the East, the financial center known as Wall Street, have designs on and covet the ownership of the commercial banks of the Nation. They are now being merged into larger and larger groups. The time is not very far distant, I predict, when the squeeze will be put on, and the commercial banks forced into one huge system controlled from Wall Street unless the Congress and the people rise up and stop this definite trend.

An outstanding example of such a trend has been reported in the acquisition and control of 200 banks in the State of New York under a holding company known as the Marine Midland, which permits a few people to control these 200 banks and administer their operations. This holding company, incidentally, is domiciled in another State—at Dover, Del.—and the 200 banks in New York State could very well be operated from a telephone pay station booth in Dover.

The Marine Midland is the largest holding company in the East. No other eastern bank holding company controls so many banks in so many local communities operated from across State lines. If we do not make this investigation and the money trust is permitted to continue its present course, our national debt in the foreseeable future will be doubled or \$600 billion instead of the \$300 billion at present.

There is every incentive for those in charge of the commercial banks to expand the national debt as rapidly as possible for their own private gain. Bankers now holding Government bonds are collecting what Senator Robert L. Owen, coauthor of the Federal Reserve Act, described as unearned interest. The banks create the money on their books on the Government credit to buy Government bonds and then collect interest on these bonds from the taxpayer.

The Federal Reserve Act has been amended from time to time—usually in a depression when Members of Congress would vote for anything that was intended to help economic conditions. However, most of the amendments have resulted in giving to a few people dictatorial powers over the money supply of the Nation and the interest rates.

One such amendment, which was passed in 1935, was sharply brought to our attention last year. President Kennedy had the power under the law to select a Chairman of the Board of Governors—one of the most important offices in the civilized world. The importance of this office is due to the fact that the Federal Reserve has the power to veto through money squeezes and other means, the actions of the Executive or the legislative branch.

President Kennedy did not have freedom of choice to select the best person in the United States to be Chairman of the Federal Reserve Board. He was compelled under law to select one of the seven already on the Board—most of whom had been appointed by a preceding Republican President.

It is difficult to conceive of a free people like ourselves permitting our President to be hamstrung in this way and denied the privilege of selecting a person to his choice for this job.

“Keep money out of politics” is what you have been saying in opposition to our investigation of the Federal Reserve System. But if the Government doesn't control money, who will? We can't do without controls, and in fact, the Federal Reserve does control the value of money and the level of interest rates. The question then is, Who should control the Fed?

At the moment private bankers have a lot to say about what the Fed does. Private bankers elect two-thirds of the directors of each of the 12 Federal Reserve banks, and these directors in turn elect the 12 Federal Reserve bank Presidents. The Federal Open Market Committee is the all-powerful group that finally determines the volume of money and the level of interest rates, and this Committee is legally composed of 5 of the 12 Federal Reserve bank Presidents plus all 7 Governors of the Fed. (These Governors are appointed by the Presi-

dent of the United States.) It is curious that in practice through some extra-legal procedure all 12 Federal Reserve bank Presidents participate in Committee decisions. The end result is clear—the 12 men elected by representatives of private banks outnumber the 7 Governors who as Presidential appointees might be expected to vote in the interest of all the people.

The Constitution says that Congress shall regulate the value of money. Congress cannot afford to abdicate its monetary responsibilities to anyone, and especially not to bankers.

Our Constitution gives the people the right to control the enormous powers of monetary policy through their elected representatives. In a democracy there can be no other way. If elected officials control the Fed, as the Constitution requires, the people will have a chance to vote approval or disapproval of their actions. But if the bankers continue to control the Fed, there is no way for the people to vote against them when they do not serve the public interest. Congress is responsible to the people. Private control is a money dictatorship repulsive to our form of government.

I believe in the private commercial banking system—preferably a system that has locally owned and locally controlled banks, all having the privilege of expanding the money supply to help local people and making reasonable profits. Only a profitable banking system can help the Nation achieve maximum growth.

It is my sincere hope that you will not continue to sabotage, block, or interfere with a fair, complete, and helpful investigation of the Federal Reserve System. Such an investigation is now being conducted in the public interest by the Subcommittee on Domestic Finance of the House Banking and Currency Committee.

Sincerely yours,

WRIGHT PATMAN.

The CHAIRMAN. Thank you again very much, sir. We will excuse you again with the thanks of the committee.

The committee will stand in recess subject to call of the Chair.

(Whereupon, at 11:50 a.m., the committee was adjourned, subject to the call of the Chair.)



## APPENDIX

---

### STATEMENT TO SUPPLEMENT THE TESTIMONY OF GEORGE W. MITCHELL AND J. DEWEY DAANE BEFORE THE SUBCOMMITTEE ON DOMESTIC FINANCE OF THE HOUSE BANKING AND CURRENCY COMMITTEE ON MARCH 4, 1964

This statement responds to the request of Representative Reuss that we examine the growth of the money supply (defined, in Professor Friedman's terms, to include time deposits at commercial banks) over the period since 1953 and compare the results, in terms of the effect on the economy, with what would have occurred if the Federal Reserve had followed Professor Friedman's prescription and increased the money supply steadily by 4 percent per year. This response will therefore be framed in terms of money supply growth—but this should not be taken to imply acceptance of Professor Friedman's approach to monetary analysis.

The data, on an annual basis, are shown in table 1. It may be seen that over the entire period from the end of 1953, the money supply (defined in Professor Friedman's sense) has increased on the average by 4.4 percent per year. In other words, the Federal Reserve has, on balance over the past decade, pursued a somewhat more expensive policy than was called for by Professor Friedman's automatic formula.

The time pattern of the monetary expansion was rather different from what would have occurred under the Friedman prescription. If the Federal Reserve had followed this prescription, its policy would have been more stimulative in the years 1955-57 and 1959-60 and its policy would have been less stimulative in 1958 and 1961-63.

Now 1955-57 were years of near-full employment. The unemployment rate averaged 4.3 percent during these 3 years; the gap between actual and potential GNP, as computed by the Council of Economic Advisers, was relatively small. But prices were rising significantly. Yet under the automatic formula, the Federal Reserve would have been called upon to increase bank reserves more rapidly so as to permit faster growth of total bank deposits and currency. During the past 3 years (1961-63), on the other hand, when prices have been stable, unemployment has been excessive, and the gap between actual and potential GNP has been persistently large, the automatic formula would have called for a more restrictive monetary policy than was in fact pursued. The money supply would have increased considerably less and interest rates would have been higher than they have been. The automatic formula would thus have led to greater upward price pressures in 1955-57 when inflation was a major problem and to smaller total demand in 1961-63 when unemployment was a major problem.

For the years 1955-57 and 1961-63, therefore, we find it very difficult to believe that application of the automatic formula would have yielded better economic performance in terms of maximum employment, production, and purchasing power than actually resulted from discretionary monetary policy. One need not claim that monetary policy was perfect in order to conclude that it was more appropriate to the condition of the economy than a steady 4 percent per year expansion in bank deposits and currency these two expansion periods.

We turn now to an appraisal of monetary developments in late 1957 and 1959-60, periods in which the performance of monetary policy has aroused the greatest criticism. This appraisal is made in terms of changes in the Friedman money supply in order to be responsive to Representative Reuss' request.

In our judgment the evaluation of monetary actions taken in these periods should rest on different grounds.

As far as 1957 is concerned, it will be seen from the last column of table 2 that the rate of growth of the money supply (including time deposits) did not fall off significantly until after the economy had turned down in the summer. During the first 7 months of 1957, monetary growth was at a rate of about 3 percent per year, somewhat more rapid than in 1956. It was only after the demand for funds slackened with economic activity that money supply growth declined significantly. It would be difficult therefore to attribute the downturn in the economy to monetary developments in 1957.

In early 1958, monetary expansion accelerated sharply, in response to Federal Reserve actions to combat the recession. For the year as a whole, the increase of bank deposits and currency came to almost 7 percent (table 1).

Beginning in the autumn of 1958, the rate of monetary expansion slackened again (table 3). By the autumn of 1959, money supply, including time deposits, began to decline. Over the 9 months from September 1959 to mid-1960, there was a contraction of about 2 percent.

Thus if one is prepared to accept Friedman's analytical framework and to ignore the other factors that we feel must be taken into account in evaluating monetary policy, the evidence is still lacking to support the proposition that adherence to an automatic formula calling for 4 percent monetary growth per year would have given better results than discretionary monetary policy, except perhaps for the period 1959-60.

Having responded to Representative Reuss' question in terms of Professor Friedman's approach, as requested, we would like to add the following brief comments on the foregoing analysis:

(1) We find no rationale, in theory or operating experience, for selecting this particular monetary variable—currency plus demand deposits plus time deposits—as especially strategic. We are convinced that constructive monetary policy—that is, policy which contributes effectively to the achievement of maximum employment, production, and purchasing power—is a more complex matter than merely manipulating one particular total on the assumption that one can control the level of GNP in this way or even that the effects of monetary policy are transmitted solely through this channel.

(2) A particular weakness in the automatic approach appears in the years 1962 and 1963. As a result of two increases in interest rates on commercial bank time deposits (as permitted under regulation Q), banks were able to attract in these 2 years an extraordinary volume of time deposits. To a significant extent, these funds represented a diversion of flows that would otherwise have gone either to the securities markets or other financial institutions. This means that much of the expansion in time deposits (and in the broadly defined money supply) represented a rechanneling of savings flows, as banks enlarged their role as intermediaries. To regard the entire increase in bank deposits as "monetary expansion" is to exaggerate the degree of monetary ease in 1961-63. Once again we affirm that simple mechanical approaches to monetary problems can be highly misleading.

TABLE 1

[Dollar amounts in billions]

	Demand deposits plus currency	Change	Percent change	Time deposits	Total	Change	Percent change
December 1953.....	\$128.8			\$44.6	\$173.4		
December 1954.....	132.3	3.5	2.7	48.4	180.7	7.3	4.2
December 1955.....	135.2	2.9	2.2	50.2	185.4	4.7	2.6
December 1956.....	136.9	1.7	1.3	52.1	189.0	3.6	1.9
December 1957.....	135.9	-1.0	- .7	57.5	193.4	4.4	2.3
December 1958.....	141.2	5.3	3.9	65.5	206.7	13.3	6.9
December 1959.....	142.0	.8	.6	67.4	209.4	2.7	1.3
December 1960.....	141.2	-.8	-.6	72.7	213.9	4.5	2.1
December 1961.....	145.7	4.5	3.2	82.5	228.2	14.3	6.7
December 1962.....	147.9	2.2	1.5	97.5	245.4	17.2	7.5
December 1963.....	153.5	5.6	3.8	111.8	265.3	19.9	8.1
Average change.....		2.5	1.8			9.2	4.4

TABLE 2  
[Dollar amounts in billions]

	Demand deposits plus currency	Change	Change at annual rate	Annual percent change	Time deposits	Total	Change	Change at annual rate	Annual percent change
December 1956	\$136.9				\$52.1	\$189.0			
January 1957	136.9	0	0	0	52.6	189.5	0.5	6.0	3.2
February 1957	137.0	.1	1.2	.9	53.1	190.1	.6	7.2	3.8
March 1957	137.1	.1	1.2	.9	53.7	190.8	.7	8.4	4.4
April 1957	136.9	-.2	-2.4	-1.8	54.1	191.0	.2	2.4	1.3
May 1957	137.0	.1	1.2	.9	54.5	191.5	.5	6.0	3.1
June 1957	136.9	-.1	-1.2	-.9	54.8	191.7	.2	2.4	1.3
July 1957	137.0	.1	1.2	.9	55.3	192.3	.6	7.2	3.8
August 1957	136.9	-.1	-1.2	-.9	55.6	192.5	.2	2.4	1.2
September 1957	136.7	-.2	-2.4	-1.8	56.0	192.7	.2	2.4	1.2
October 1957	136.4	-.3	-3.6	-2.6	56.6	193.0	.3	3.6	1.9
November 1957	136.1	-.3	-3.6	-2.6	56.9	193.0	0	0	0
December 1957	135.9	-.2	-2.4	-1.8	57.5	193.4	.4	4.8	2.5
Average change: January to December		-.8	-1.0				.4	4.4	2.3
January to August		0	0				.4	5.3	2.8

TABLE 3  
[Dollar amounts in billions]

	Demand deposits plus currency	Change	Change at annual rate	Annual percent change	Time deposits	Total	Change	Change at annual rate	Annual percent change
December 1957	\$135.9				\$57.5	\$193.4			
March 1958	136.5	0.6	2.4	1.7	60.5	197.0	3.6	14.4	7.4
June 1958	138.5	2.0	8.0	5.9	63.2	201.7	4.7	18.8	9.5
September 1958	139.5	1.0	4.0	2.9	64.7	204.2	2.5	10.0	5.0
December 1958	141.2	1.7	6.8	4.9	65.5	206.7	2.5	10.0	4.9
March 1959	142.5	1.3	5.2	3.7	66.2	208.7	2.0	8.0	3.9
June 1959	143.4	.9	3.6	2.5	67.0	210.4	1.7	6.8	3.3
September 1959	143.2	-.1	-.4	-.3	67.2	210.4			
December 1959	142.0	-1.2	-4.8	-3.4	67.4	209.4	-1.0	-4.0	-1.9
March 1960	141.0	-1.0	-4.0	-2.8	67.1	208.1	-1.3	-5.2	-2.5
June 1960	140.0	-1.0	-4.0	-2.8	67.9	207.9	-.2	-.8	-.4
September 1960	140.9	.9	3.6	2.6	70.3	211.2	3.3	13.2	6.3
December 1960	141.2	.3	1.2	.9	72.7	213.9	2.7	10.8	5.1

COMMENT BY GOV. GEORGE W. MITCHELL ON PROF. MILTON FRIEDMAN'S COMMENT ON ISSUES RAISED IN GOVERNOR MITCHELL'S TESTIMONY BEFORE THE SUBCOMMITTEE ON DOMESTIC FINANCE OF THE HOUSE BANKING AND CURRENCY COMMITTEE ON MARCH 4, 1964

I welcome the opportunity provided me by Chairman Patman to comment briefly on certain of the issues raised in Professor Friedman's comment on my testimony.

In pointing out that the application of his monetary rule would have resulted in a more restrictive monetary policy than I believed desirable in recent years, I was not trying to select an arbitrary timespan that was prejudicial to his approach. I did intend to reveal the vulnerability of his inflexible rule and definition of the money supply to a great variety of institutional and environmental changes. Professor Friedman complains it was the Board's action that brought on the change in the competitiveness of bank time accounts and caused

his measure of money supply (which includes time deposits) to grow faster than the narrowly defined money supply. But the relative competitiveness could also have been affected by a ruling of another Federal or State regulatory agency (as it was in January 1964); by a change in interest rates on marketable securities relative to rates offered by banks on time deposits; by a change in the compensating balance requirements imposed by banks on their customers, or by the substitution of banking service charges for compensating balance arrangements; by innovations in time deposit instruments, such as the recently introduced negotiable certificate of deposit; by even as simple a development as a shift from monthly to weekly salary payments; and by numerous other environmental, technological, and institutional factors that affect either or both the demand for money and near money.

There is no guarantee that such changes will average out to smooth and gradual changes in the public's desire for money—or, for that matter, for Friedman money, or for money plus all near money. On the contrary, some of these changes can be quite abrupt. Negotiable time certificates of deposit, for example, grew from about \$1 billion to over \$10 billion in the past 3 years, accounting for nearly one-quarter of the total growth in commercial bank time deposits. Yet these time certificates are not so much substitutes for idle demand deposit balances as rather a vigorous new competitor for the type of funds that would otherwise be invested in Treasury bills or other money market instruments.

Shifts in the demand for money and near money of the types cited above occur frequently, but with sufficient irregularity and unpredictability so that no foreordained policy guide can comprehend them. To use Professor Friedman's own analogy, the problem is not merely that the pilot may jiggle the automatic pilot; rather, the environment, through which the automatic pilot is supposed to steer a steady course, changes so often that the pilot must continually be prepared to override the automatic pilot with manual corrections for unprogrammed shifts.

This concept of monetary management puts in a different light Professor Friedman's statement that monetary expansion should have been smaller over the past 15 months because the money supply has "been growing at a faster rate than can be maintained indefinitely." One of the advantages of discretionary monetary policy is that the rate of growth of money and credit can be varied over time, if called for by economic stabilization. In contrast with what would happen with Professor Friedman's prescription for automatic and steady growth of monetary magnitudes, under discretionary monetary policy the longrun unsustainability of a given rate of monetary expansion does not rule it out in the short run.

My differences with Professor Friedman would not be resolved even if we agreed on whether a narrow or broad definition of the money supply is preferable. A more basic question concerns the degree of emphasis placed upon the money supply, however defined. Professor Friedman agrees with me that the causal relationship between changes in money supply and in economic activity has not been adequately delineated. He then turns this agreement against me by asking how I can justify discretionary monetary policy if I concede imperfect knowledge as to the relationship between the money supply and economic activity.

One of the points at which Professor Friedman and I can agree is that we need more knowledge about the behavior of the money supply in relation to changes in economic activity. I can even go further and agree that the Federal Reserve's exposition of its monetary analysis has been too shrouded in confidentiality, "Federalese," and the traditional image of central banker stolidity. But I am sure he has pierced the monetary veil sufficiently to know that the Federal Reserve is not at a loss for guides to or evidence of monetary action because of uncertainties as to the behavior of the money supply. The System acts in response to a variety of credit indicia including levels and patterns of interest rates, bank and nonbank credit flows, changes in the relationship of bank to total credit, credit market expectations, as well as movements in the money supply and other liquid assets. The linkage between monetary action and credit factors and, in turn, between such factors and final spending are logically explicable and empirically demonstrable (more so, many believe, than is true with respect to the money supply). But the desirable precision in quantitative relationships is not available under this approach either. Much work remains to be done. But enough is known to provide better guidance to the monetary authorities than an inflexible money supply formula that would have intensified inflation in 1955-57 and would have accentuated unemployment in 1961-63.

Professor Friedman and I also appear to disagree on the facts regarding the behavior of velocity or turnover; he states that "the facts are the very opposite of what" I assert them to be. In part, this difference may reflect a focus on differing phenomena. Professor Friedman's references to velocity are typically aimed at the ratio of money supplied to national income (income velocity); while by money turnover I mean to refer to the ratio of the money supply to total checks written on deposits (what is commonly termed "transactions velocity"). The economy's need for money as a transactor is geared to asset, debt, and financial transactions to a much greater extent (60 percent of total use) than to production distribution and consumption transactions. Moreover they appear to have different cyclical patterns. The turnover measure therefore has the advantage of incorporating the public's total need for money; first differences in this series may reflect more accurately and promptly than any other measure we presently use changes in the demand for money.

Both measures have occasionally demonstrated a tendency to shift in ways that partially counteract the direction of change in the money supply. In reply to a question of Congressman Brock, I pointed out how changes in transactions velocity may sometimes offset changes in the money supply. What I had in mind is that, in recent years especially, a faster rate of growth in the money supply has often been accompanied by a slower rate of growth, if not a decline, in the rate of turnover of money, while a slower rate of growth of the money supply has usually gone along with a faster rise in money turnover. Such differences have been more than can readily be accounted for by assumed responses to a simple "too slow" or "too fast" money supply growth, and partly reflect the impact of such factors as I mentioned in the second paragraph of this comment.

With reference to income velocity, Professor Friedman's own work in this field acknowledges that income velocity tends to rise during cyclical expansions and to fall during cyclical contractions. In recent years—and it is recent behavior that current policy formulation must be based upon—the money supply has increased faster in slack periods than in periods of expansion. Thus, even with regard to income velocity, the recent evidence seems to support the observation I made in response to Congressman Brock.

(The article submitted by R. M. Robertson follows:)

#### THE MYSTERIOUS WORLD OF THE FED

(By Delbert C. Hastings<sup>1</sup> and Ross M. Robertson<sup>2</sup>)

First-time visitors to the lovely Washington building that houses the Board of Governors of the Federal Reserve System are invariably struck by its lofty tone. Federal Reserve personnel and guests alike move decorously through marble halls and amber-lit, carpeted rooms that epitomize the vast dignity of the monetary authority. Highly placed staff members approach the offices of Board members with deference; lesser functionaries enter with an obsequious respect that makes onlookers uncomfortable. Indeed, an almost religious aura pervades the place, and the uninitiated expect momentarily to catch a whiff of incense or the chant of choirboys not far off.

The physical atmosphere is simply an extension of a carefully nurtured public image of trustworthiness and high morality. Because of the technicality of its operations and the obscurity of its statements of purpose, the Federal Reserve has avoided evaluation and criticism of its actions by the public at large. Instead, explicit comment has been left to academicians, highly placed financial managers, and a few Members of Congress. Thus, the public trusts the Fed without fully understanding it; with the possible exception of the Federal Bureau of Investigation, no other Government agency enjoys such high repute and splendid public relations.

To be sure, much of the System's prestige is merited. It performs its vast service roles—collector of checks, fiscal agent for the U.S. Government, and issuer of currency—with accuracy and dispatch. At both Board and bank levels, the Federal Reserve can boast a research organization second to none. Yet it is by no means certain that the Fed has managed the money supply better than the money supply would have managed itself, nor is it clear that Federal Reserve

<sup>1</sup> Mr. Hastings is professor of statistics and director, Division of Research, School of Business Administration, University of Minnesota.

<sup>2</sup> Mr. Robertson is professor of business economics and public policy and director of business history studies, School of Business, Indiana University.



influence on growth, stability, and price levels has been as beneficial as the Fed's reputation would suggest.

In a word, the Federal Reserve System has nobly performed its service functions. On the other hand, it is by no means certain that the control functions have been discharged with the imagination and vigor that modern central bank action requires. Painfully sensitive to criticism, which invariably evokes defense reactions, the monetary authority gives continual evidence of an eroding self-consciousness. Indeed, System acceptance of responsibility for stability of prices and output seems to vary from time to time. The Fed certainly wants no competitors; whenever it has been suggested that an administration economic policy group be formed, there is immediate central bank resistance to the proposal. Yet System authorities occasionally come close to admitting their inability to stabilize the economy, and, whenever the congressional heat is on, central bank spokesmen are at pains to explain that they can only nudge the economy in one direction or another, that there are too many variables to be controlled by any one institution. System attitude seems to be, "We will use the tools we choose in the way we choose, and if they don't do the job, we deny responsibility in the matter. But we don't want anyone else interfering." To understand the Fed, we must apprehend this deep-rooted instinct for self-preservation that manifests itself in insistence upon insulation from "political" interference.

The mysterious world of the Fed is really known only to its employees and its alumni—the insiders, as it were. No amount of examination, no amount of congressional testimony, no amount of study by scholars temporarily connected with the System can reveal the inner workings of Fed mentality. Only years of participation in the charismatic effort of central bank policy provide the sense of System motivation so essential to an interpretation of Fed dogma, facetiously referred to, internally, as the "party line." As alumni, now a decent interval away from System activity, we herewith set forth our observations about (1) the modes of power in the System and (2) the tenuous lines of communication that carry power impulses from one node to another.

#### THE NODES OF POWER

Although its major structural outlines were laid down by the original Federal Reserve Act, the Federal Reserve System has evolved in a way clearly not foreseen by its founders. As in every organization that must act, there are important nodes of power within the System; the relative standing of these power centers depends somewhat on law, somewhat on custom, and somewhat on the economic facts of life, such as the size and wealth of the different Federal Reserve districts. In roughly descending order of power, the major nodes are as follows: (1) The Chairman of the Board of Governors; (2) the other Governors; (3) the staff of the Board, in particular the senior advisers; (4) the Federal Open Market Committee; (5) the trading desk of the New York Federal Reserve Bank; (6) the President of the New York Federal Reserve Bank; (7) other Federal Reserve bank Presidents; (8) boards of directors of the 12 banks; (9) System-wide committees, standing and ad hoc; and (10) the Federal Advisory Council.

This listing will doubtless raise eyebrows both inside and outside the System, but we consider it, nonetheless, a fair appraisal of the current order of power loci in the System. It is impossible to understand the operations of today's central bank without knowing the relative importance of these power centers.

It is common knowledge, of course, that the Banking Act of 1935 made a drastic switch in the seat of System power. Under the aegis of Benjamin Strong, fair-haired boy of J. Pierpont Morgan and the 1913 New York banking community, real authority in the System lodged in the hands of the chief executive officers of the several Reserve banks. Indeed, the quick seizure of the term "governor" by the executive heads of the 12 banks revealed their own assessment of their authority. Until Strong's death in 1928, the Federal Reserve Board made nearly futile efforts to seize the power it never had, and the terrible failure of the Federal Reserve to arrest the deflation of 1929-32 gave positive proof, if proof were needed, that Board authority had been emasculated in practice. The designation in the Banking Act of 1935 of the "Board of Governors" signified the intent of Congress to make it the "board of bosses."

Even so, no one could have foreseen a generation ago the gradual settling of vast power in the person of the Chairman of the Board. The tradition of Chairman domination was, of course, started during the reign of Marriner S.

Eccles, but it has reached a new high under Chairman William McChesney Martin, Jr., able son of one-time Governor Martin of the St. Louis Reserve Bank.

This is not to say that other Board members are without authority. Yet the position of each one depends upon his intellectual quality and personal force. A Board member not deemed a contributor to the welfare of the System is likely to be shunted aside and given assignments that keep him away from inner councils. On the other hand, a particularly knowledgeable Governor may be given heavy responsibilities, especially if he has a bent for economic or legal analysis.

The fact remains that the Chairman of the Board is in a position to exercise a great measure of control over the Board and thus over the entire System. His is the final word on appointments at both Board and bank levels. He is the System spokesman in its relationships with Congress, other executive branches of the Government, the President, and even with foreign governments. Within the law, his powers are circumscribed only by the personal qualities of the other Governors and by the 5-year term of his appointment to the chair. When, as in the case of Martin, the Chairman possesses an uncommon singleness of purpose and great political ability, he will work by persuasion rather than by ukase. He nevertheless operates as a dominant political figure in the best and highest sense of the word.

The staff of the Board of Governors, particularly the senior advisers, are a frequently overlooked power center. To be sure, their influence is derived from that of the Governors. But their proximity to the Governors, their long service, and their familiarity with Fed history give them a more than considerable influence on policy matters. Old pros like Woodlief Thomas and Ralph A. Young command enormous prestige. Younger men like Guy E. Noyes, Director of Research and Statistics, exert their influence through control of research activities at both Board and bank levels; all publications of the several banks as well as reports of System-wide committees must receive the approval of the Board staff before release, and directives sent by staff members to the banks are accepted as bearing the authority of the Board of Governors.

Because it nominally determines the magnitude and direction of the most important monetary weapon—purchases and sales of Government securities—the Federal Open Market Committee is the next most powerful organization within the System. Since it is the official forum as well as the administrative body for monetary policy actions, the FOMC has a key place in System councils. As late as 1953, the Open Market Committee met only quarterly, with an executive committee meeting more frequently to perform the significant policymaking functions. Since that time, however, the full Committee has met at intervals of approximately 3 weeks. Although the official membership consists of the seven Governors and five of the 12 bank Presidents, all the Presidents try to attend regularly.<sup>3</sup>

Resisting the inexorable erosion of authority at the bank level, the Federal Reserve Bank of New York always poses something of a threat to Board authority in Washington. The trading desk, which administers the open market account upon receipt of FOMC directives, is the very nerve center of the System. Since, as we shall see, orders of the Open Market Committee are always ambiguous and often nebulous, the account manager, a Vice President of the New York Reserve Bank, must have great latitude in making judgments. And though he may have many masters, not excluding the senior staff member of the Board who advises with him each day, it goes without saying that the account manager's immediate boss, the President of the New York Reserve Bank, will not be without influence. Indeed, a strong New York President can be a source of great annoyance and even friction in Federal Reserve councils. It is no secret that many officers in the System heaved a collective sigh of relief when Allan Sproul, one-time chief officer of the New York bank and in some respects the most artistic of all American central bankers, went into retirement. But no matter what the attitude of a New York President toward Washington may be, the counsels of that officer are bound to have weight as they reflect the opinions of the New York financial community.

<sup>3</sup> The President of the Federal Reserve Bank of New York is a permanent member and Vice Chairman of the Committee. Membership rotates among the other bank Presidents as follows: Boston, Philadelphia, and Richmond; Chicago and Cleveland; St. Louis, Atlanta, and Dallas; and Minneapolis, Kansas City, and San Francisco.

It is no deprecation of the abilities and prestige of the other 11 bank Presidents to say that they rank well down the list of System power centers. The Presidents are in general gifted and articulate men, and their views will always be weighed by the Board and its Chairman. Nevertheless, the last remaining power of the banks vanished when the original tool of monetary management—changes in the discount rate—lost its money-market effectiveness. And since the appointments of Presidents and First Vice Presidents are subject to Board approval, really serious resistance to Board decisions is not to be expected at bank, to say nothing of branch, levels. It is probably not unfair to say that the boards of directors of the 12 banks have had their power reduced to that of nominating committees, which on occasion submit to the Board of Governors the names of possible President and First Vice President candidates. Like the boards of directors of the Reserve bank branches, their positions are largely honorific; and though the Board expresses public gratitude for the “economic intelligence” furnished by bank and branch directors, the plain fact is that their monthly meetings are simply genteel bull sessions.<sup>4</sup>

Indeed, it is probably a fair generalization that the Reserve banks, at least outside New York City, exert their remaining vestiges of influence by placing their talented officers and economists on System committees. Thus, a System Committee To Study Consumer Credit unquestionably affected Board and administration thinking with its multivolume 1957 report; more recently, a System committee has produced an influential report on the Federal funds market. Furthermore, articulate individuals like Robert V. Roosa and George Garvy of New York, Clay J. Anderson of Philadelphia, and Homer Jones of St. Louis, through their writings and oral presentations, are likely to have an earnest and respectful hearing by the policymakers in Washington. They are nevertheless a long way from the seat of power.<sup>5</sup>

The Conference of Presidents, once the vehicle of dominance over System policy, is now regarded largely as a forum for administrative and operating problems of the several banks. The Presidents advise with each other on such matters as check collection, currency and coin issue, agency functions for the Treasury, and personnel classifications. The Federal Advisory Council, never even ostensibly a part of the formal power structure, is clearly an honorific group. Although their advice is presumably weighed by the Board of Governors, council members, like directors of banks and branches, bring personal prestige and orthodox witness as their chief contribution.

#### TRANSMISSION LINES OF POWER

Few Federal Reserve insiders would make a major rearrangement of the order in which we have listed the nodes of power, but many would express the honest conviction that we have underestimated the democratic processes by which System decisions are made. A look at these procedures may be helpful to a clear comprehension of them.

As a prerequisite to understanding, we must divest ourselves of a good bit of textbook foolishness about how monetary policy is effected. Although it is customary to speak of the instruments of monetary control, there is really only one—the extension and absorption of central bank credit. The means by which central bank credit is manipulated are irrelevant. Changes in reserve requirements, though still employed, are an anachronistic inheritance from the excess reserve problem of the 1930's; any sensible person knows that required reserve ratios can be set at any level with consequent central bank and commercial bank adjustment to them. Changing the discount rate, though originally conceived to be the only weapon of monetary control, has long since lost its effectiveness; the discount rate is no longer a true money-market rate but serves simply as a Fed signal of reaffirmation of a policy in being or a change in monetary policy. In practice, the only demonstrable effect of the discount rate is to set an upper limit to the Federal funds rate; that is, the rate charged one bank by another for the short-term loan of deposits with a Reserve bank. So we are left with one important instrument of monetary control—open market operations. System intervention in the Government securities market is a day-to-day, hour-to-hour, minute-to-minute activity that intimately affects the lives of us all.

<sup>4</sup> Branches of Federal Reserve banks are a historic anomaly, originally established to salve the feelings of citizens disappointed at their failure to get a Reserve bank in their city. For this story see Ross M. Robertson, “Branches of Federal Reserve Banks,” *Monthly Review*, Federal Reserve Bank of St. Louis, XXXVIII (August 1956), pp. 90–97.

<sup>5</sup> Mr. Roosa is presently Under Secretary of the Treasury for Monetary Affairs.

We have suggested that the Chairman of the Board of Governors is by all odds the most powerful person in the System. But power is synonymous with substantial control over Federal Reserve credit. How, then, does the Chairman exercise his great influence? Largely by being the mouthpiece and deciding vote of the Federal Open Market Committee.

In the conduct of FOMC meetings, a formality is observed that requires each Governor and President in attendance, whether currently a member of the Committee or not, to give a brief economic analysis and state his policy recommendations. By custom each member, together with the Board secretary, the senior advisers, and the Manager of the Open Market Account, occupies a fixed position around the great oval table in the Committee room. After a brief business and financial analysis by the senior staff members, the Account Manager reports on his activities since the last meeting. Next, the Governors and Presidents take turns in order of their seating at the table, the circuit being made in one direction at one meeting and in the opposite direction at the next. The Chairman speaks last, customarily framing his closing remarks in the form of a consensus of the preceding recommendations. Often, however, there is less than complete agreement among Committee members; less often, but not infrequently, the Chairman may wish to give stronger than usual direction to current policy. In such circumstances, the "Martin consensus" has emerged, this consensus being largely the view of the Chairman himself, whether or not it coincides with that of the majority. Rarely—if then—are policy recommendations put into a motion and voted upon.

The Account Manager listens to the discussion and at its conclusion is asked by the Chairman if he comprehends the wishes of the Committee. He almost always answers in the affirmative. But though the Account Manager listens with great care, even tabulating the recommendations of each speaker, FOMC members frequently complain that they cannot communicate precisely with the Manager. This problem has several dimensions. First, each Committee member, being a rugged individualist, would probably be satisfied with little less than complete direction of current policy. Second, because the FOMC does not make a precise statement of its wishes, the Account Manager must consider 19 sets of recommendations, some of them rambling discourses on the state of the Union. Third, the 3-week interval between meetings is long enough to require adaptations on the part of the Manager, and these cannot possibly coincide with all 19 Committee opinions. Fourth, policy recommendations of FOMC members are stated in terms that are at best ambiguous "a little tighter," or "about the same degree of ease," or "shoot for net free reserves between \$500 and \$600 million." Committee members frequently disavow the free reserves target, pointing out that it lacks sufficient connection with the complex of economic variables to be useful as a measure of the effectiveness of policy. It is little wonder then that communication between the FOMC and the trading desk is poor. Nor is it any wonder that Chairman Martin, for better or worse, must determine a consensus that would lead only to endless argument if it were brought to a vote.

A more basic difficulty of communication arises from the unwillingness of the Committee to state its economic outlook in precise terms. There exists in the Federal Reserve System an unwritten rule against explicit forecasting of business conditions; even modest attempts at prognosis are blue-penciled if written and ignored if expressed verbally. Members of the FOMC often remark that "we are making policy only for the next 3 weeks," the implication being that inaction or wrong action can be reviewed or corrected at the next meeting. Now it is manifestly impossible to frame an intelligent monetary policy without at least implicit forecasting; and since a major objective of monetary policy is cyclical amelioration, the forecast period must be a major portion of a cycle. Fortunately, many FOMC members have their own unstated projections. But the emphasis on the short term, the avoidance of a solid, common forecast, and the frequency of FOMC meetings all lead to erratic action, lagged responses, and policy more often than not based on correction of past errors rather than on anticipation of future events.

But whatever the difficulties and ambiguities of communicating with the trading desk, transmissions are made and received. However, the man in charge of the desk, no matter how dedicated, has a rough, tough job. If, as is frequently true, the FOMC has set some range of free reserves as its most precise measure of policy direction, the Account Manager ideally tries to achieve this goal in his day-to-day operations. But the goal is elusive, simply because some of the money-market factors affecting reserves cannot be predicted at all and others

can be estimated only with difficulty. (Actual figures may become available only 2 or 3 weeks later.) Actions taken by the desk on the basis of the daily predictions of the money-market factors frequently turn out to have been perverse—in the wrong direction. The chief upsetting factor, of course, is Federal Reserve float, which is extremely volatile and almost completely unpredictable on a daily basis. Float could be safely ignored on a daily basis and dealt with only on a weekly average basis. Federal Reserve studies having shown that commercial banks do not alter their short-term investment positions on the basis of changing float levels. Yet fear of commercial bank response ostensibly forms the basis for the frequency of a Fed's float-offsetting action, with consequent uncertainty in the money markets when desk action is in the wrong direction.

Another major influence on the administration of the trading desk is the solicitude of the Fed for the Government security dealers, particularly for the nonbank dealers. The basic premises of this solicitude are that a "broad, deep, and resilient" market for Government securities is necessary for successful Federal Reserve action and that such a market can be made only by financially impregnable dealers who can obtain financing on favorable terms. A "negative carry"—that is, a yield on any security held in inventory smaller than the rate paid on funds borrowed by the dealer—is taken as conclusive evidence that financing terms for the dealers are not favorable. The same concern is not felt for bank dealers, since they are assumed to have a ready internal source of funds to finance their positions.

Solicitude for the dealers is expressed in several ways. For example, the FOMC has approved and the desk has made frequent use of the repurchase agreement. Although this instrument is a means by which the desk can make bank reserves available for a short time with automatic withdrawal, it is also a means by which short-term credit is extended to a dealer.<sup>6</sup> The timing is usually to the advantage of the dealer, because the desk makes the privilege available when there is a real pinch in the money market. The repurchase agreement is in reality a fully secured loan; the desk purchases securities (bills) from the dealer, who agrees to repurchase them within a definite period (maximum, 15 days). Interest is computed on the basis of amount and term of loan rather than by reckoning the difference between purchase and sale price of the bills, as would be true in the case of a true purchase and repurchase.

Fed concern for the Government securities dealer is further demonstrated by the expressed opinion that the money-market banks ought to favor the securities dealers in financing arrangements, particularly during tight-money periods. The money-market banks have protested that no group ought to be favored merely because of its function. Although the interest of the Fed authorities in maintaining a facilities market organization is understandable, it is doubtful that financing favoritism is essential to a strong dealer organization. A hands-off attitude, requiring dealers to stand the market test of services rendered, charges made, and competition for custom, seems more likely to achieve ultimate Federal Reserve aims.

Nor is arranging Fed intervention in the Government securities market to suit the convenience of nonbank dealers likely to inspire public confidence. Federal Reserve acceptance of the notion that System entry into the Government securities market should be in short issues, preferably bills, had its philosophical basis in a weird principle of "minimum effective interference," a mystical idea that the limitless authority of the central bank could somehow be softened by dealing in securities "closest to money" in the spectrum of financial assets. But a careful reading of the famed "Ad Hoc Subcommittee Report of 1952" makes it clear that strong support for the "bills only" dogma came from the dealers, who would avoid, for obvious reasons, "capricious" System purchases and sales throughout the maturity range of the Treasury list. Dealers with positions in bonds naturally want to be warned of fluctuations in bond prices by preliminary changes in the prices of bills.

#### RETURN TO REGIONALISM?

Knowledgeable men know perfectly well that the informal power structure of an institution—whether a Christian denomination, a great corporation, or a university—may well be more important than its formal one. So long as the distinction is clear, so long as people are aware of what is really going on, it makes

<sup>6</sup> Compare Robert V. Roosa, "Federal Reserve Operations in the Money and Government Securities Markets" (New York: Federal Reserve Bank of New York, 1956), esp. pp. 25–28 and 83–87.

little difference whether the formal or informal power centers are operative. But it makes a great deal of difference if the people in a democracy, unaware of the arbitrary nature of the actual decisionmaking, go on believing that the money power, like all other sovereign power, is responsive to democratic processes. For plainly it is not.

We do not for one moment question either the integrity or the sincerity of the money managers. If government at all levels were staffed by men of the competence and dedication of those found in the Federal Reserve System, the American political system would be upgraded tremendously.

We do believe, however, that a realistic appraisal of System structure in terms of its genuine power centers leads to only one conclusion—that the regional structure, adopted by the framers of the Federal Reserve Act two generations ago, is presently outmoded and has become an expensive anachronism. We may as well face up to the fact that Federal Reserve banks have become only operating offices with responsibility for service functions and not, in any real sense, for monetary policy.

In our view a workable regional system could be devised. A return to regional structure would require, as a very minimum, restoration of the discount rate as an instrument of monetary control. Such a restoration implies the rescinding of regulation A, the complex and meddlesome set of rules by which the 12 discount windows are presently administered. It further implies free access to discount windows at whatever rates the regional banks prescribe.

Ostensibly, the discount rates of the several banks are set by their boards of directors. In practice, they are raised and lowered at the wish of the board. When Chairman Martin senses the strategic moment has arrived for a discount rate change, he initiates action via a discreet telephone call to one or more bank Presidents out in the provinces. Once a Reserve bank President (at St. Louis, Kansas City, Atlanta, or Dallas, for example) has the word, it is up to him to get his Board of Directors, or the executive committee of his Board, to do what the Reserve Board wants. When the change is made, the business press ordinarily announces it as the simultaneous decision of two or more banks. Within 10 days or so, all the other banks fall in line—not by mere chance, you may be sure.

There is much to be said for operating the discount window on a rate basis rather than on an administered basis. To be sure, Federal Reserve credit must be injected partly with regard to grand strategic considerations, as determined by the board and the New York bank. But much of the hour-to-hour and day-to-day intervention by the trading desk could be avoided by letting the commercial banks tell the Fed when they need reserves. It sounds a little old-fashioned to suggest that the private banking community may on occasion know what's best for it, but we'd like to return some of the reserve-injection initiative to the commercial banks.

There are reasons why it may be impossible to go back to a regional system. For one thing, the American economy has lost most of the provincial characteristics that marked it as late as the eve of World War II. For another, our understanding of monetary (stabilization) theory has changed since the formation of a geographically decentralized central bank, placing emphasis on unified control of the economy rather than on patchwork assistance to parts of it.

Yet there would be a demonstrable gain from making central bank control less authoritarian. Moreover, continued centralization of the money power leads logically to the ultimate in a centralized power structure—combination of the central bank and the Treasury under a single head. Those who feel that such an arrangement bodes no good would do well to reflect on the possibility of greater reliance on markets in the implementation of central bank policy.

---

(The article submitted by R. M. Robertson follows:)

CREDIT POLICY AT THE DISCOUNT WINDOW<sup>1</sup>

(By C. R. Whittlesey)

The purpose of this article is to correct certain prevailing misconceptions with respect to discounting by the Federal Reserve banks.<sup>2</sup> The justification for attempting to do so is that the terms in which discount operations are customarily described give a false impression of what actually takes place; the idea is simply

<sup>1</sup> This article was written during tenure of a faculty research fellowship granted by the Ford Foundation.

<sup>2</sup> As distinguished, that is, from changes in the discount rate, see below, p. 208, footnote 5.

not correct that the discount window is the locus of a selective process where, in the interest of economic stabilization, some banks asking to borrow are accepted and others refused.

#### MISCONCEPTIONS CONCERNING DISCOUNT PRACTICES

The view that member banks are, in fact, subject to refusal of requests for loans is well grounded in the words of the Federal Reserve Act:

"The Board of Governors of the Federal Reserve System may prescribe regulations further defining within the limitations of this Act the conditions upon which discounts, advancements, and the accommodations may be extended to member banks. Each Federal Reserve bank shall keep itself informed \* \* \* in determining *whether to grant or refuse* advances, rediscounts, or other credit accommodations."<sup>3</sup>

The idea is carried forward in the Board's familiar little handbook describing the Federal Reserve System: "When a member bank applies for accommodation, the Federal Reserve bank is under no automatic obligation to grant the credit."<sup>4</sup>

In these examples and elsewhere, although the language seems to suggest that member banks are sometimes refused credit, it does not specifically state that this is the case.

Similar statements are to be found in publications by the various Federal Reserve banks. In a recent annual report of the Federal Reserve Bank of Cleveland the steps in borrowing by member banks are listed in detail:

1. Request is made \* \* \*
2. A note is executed \* \* \*
3. Consideration is given \* \* \*
4. If the loan is approved \* \* \*.<sup>5</sup>

Statements abound elsewhere in the literature on the Federal Reserve and recur in current discussion of monetary policy indicating that applications for loans by member banks are, in practice, subject to refusal by the Reserve banks. Such views are expressed alike by practicing bankers and by academic students of banking and monetary policy. They proceed also from highly placed officials of the Federal Reserve System.

Close examination of such statements will usually show that they are not technically incorrect inasmuch as they do not explicitly state that the selection occurs at the discount window itself rather than earlier, e.g., prior to the step 1 referred to in the preceding paragraph. It would appear, however, that only the very sophisticated reader would fail to infer that refusals occur at the discount window, i.e., at step 4. Examples of such statements are:

"The authority of each Federal Reserve bank to grant or refuse requests for discounts is of considerable significance in the operation of the discount mechanism in that it tends to strengthen the mechanism as a restrictive device."<sup>6</sup>

"Banks have been forced to turn to borrowing. \* \* \* But bank reserves supplied in this way represent a privilege, not a right; discounts may be refused."

A clear illustration of erroneous inferences being drawn from statements such as these is to be found in a colloquy between the president of the New York Federal Reserve Bank and a Congressman from the State of New York at congressional hearings late in 1957.

"Mr. HAYES. We hope that our *administration at the discount window* prevents a bank from abusing the opportunity to make a substantial spread. \* \* \*

"Mr. MULTEB. By the control of the discount window, making discounts or refusing to make discounts, you can control the amount of credit the bank

<sup>3</sup> Sec. 4, par. 8. Italic supplied. The subsequent provision of this paragraph with respect to suspending a member bank "from the use of the credit facilities of the Federal Reserve System" is likewise one that is not actually put into effect and, so far as has been determined, never has been.

<sup>4</sup> "The Federal Reserve System: Purposes and Functions," Board of Governors (3d ed., Washington, 1954), p. 33.

<sup>5</sup> Federal Reserve Bank of Cleveland, Annual Report, 1956, p. 14.

<sup>6</sup> Charis Walker, "Discount Policy in the Light of Recent Experience," Journal of Finance, March 1957, p. 225. Comment: The authority exists but the exercise of it does not. It may be, of course, that the statutory power to refuse has the effect stated, even though it has always remained in abeyance.

<sup>7</sup> Robert V. Roosa, "Monetary Policy Again," Bulletin of the Oxford University Institute of Statistics, August 1952, p. 258. Comment: It is true that refusal is legally possible. So far, however, as it has been possible to discover, no member bank is ever refused a loan request actually made.

can get, and no matter what the rate is, if they want the money, you can make it available to them or not, in your discretion, regardless of the interest rates? Is that it?

"Mr. HAYES. I am sure that the level of rates would not have too much influence on that."<sup>8</sup>

The impression conveyed by Mr. Hayes that loan requests are refused at the discount window was quickly corrected by the head of the Federal Reserve Bank of Richmond:<sup>9</sup>

"Mr. LEACH. The window is always open for appropriate purposes, and it is not closed in the sense that any one bank cannot come there and get funds through a loan on that day. \* \* \* We in our bank have not actually turned down any bank on a loan."<sup>10</sup>

Other Reserve bank Presidents concurred, including Mr. Hayes who, despite the impression previously left with Congressman Multer, remarked that the Reserve banks could by statute refuse to make loans as requested by member banks but in fact never do refuse.<sup>11</sup>

Another common misconception is that lending policy is adjusted to changing business conditions. The fact is that neither the way in which the discount window is administered nor the standards by which member bank borrowing is judged are modified to conform to overall monetary policy.<sup>12</sup> In the words of Mr. Leach, "our discount window doesn't vary when money is tight or money is easy."<sup>13</sup> Lending policies of the Reserve banks are governed by the provisions of regulation A as laid down by the Board of Governors. These provisions are designed to prevent individual banks from borrowing too long, too continuously, too much, or for speculative purposes. Nor does the Board ever declare that it is an appropriate time for the Reserve banks to lend; it takes the position, rather, that the purposes laid down in regulation A remain the same regardless of conditions of tightness or ease.<sup>14</sup>

In short, the administration of Reserve bank lending to member banks is directed toward the avoidance of undesirable operating practices on the part of the individual bank and not at all toward controlling the volume of credit. Nevertheless, it works out that the pressure on banks to refrain from borrowing ordinarily operates in a cyclical manner. For obvious reasons, the amount of borrowing tends to be greatest in periods of credit tightness and least in periods of credit ease. Consequently, the situations of "undue use of bank credit" contemplated in regulation A are likely to arise in the former but not in the latter periods. Such variation as occurs, however, in the pressure exerted on member bank borrowing by the Reserve banks is automatic. It does not represent, as in the case of open market operations or changes in the discount rate, the conscious adaptation of Federal Reserve policy to changing economic conditions.

#### HOW LIMITATION OF DISCOUNTING IS EFFECTED<sup>15</sup>

Although requests for loans are never refused, significant restraint may be brought upon member bank borrowing by inducing banks to refrain from further requests. This is accomplished through direct negotiation of Reserve bank officials with the officers of member banks. Where the borrowing privilege seems to be in danger of being abused the loan asked for will be granted but

<sup>8</sup> Italics supplied. "Problems of Small-Business Financing," hearings, Select Committee on Small Business, House of Representatives, 85th Cong., 1st sess., November 1957, p. 17. (Hereinafter referred to as "Hearings.")

<sup>9</sup> Confusion on this point is by no means of recent origin. A writer in the late 1920's referred to the refusal of loans by the Federal Reserve banks as "the most drastic example of direct action" (Joseph Stagg Lawrence, "Wall Street and Washington," Princeton University Press, 1929, p. 237). He then went on (p. 240) to show, however, that the limitation of borrowing was effected not by the rejection of actual loan requests but by conferring with the officers of banks which were inclined to borrow more than they should. (See below, pp. 210-211.)

<sup>10</sup> Hearings, pp. 18-19.

<sup>11</sup> *Ibid.*

<sup>12</sup> *Ibid.*, pp. 7-8.

<sup>13</sup> *Ibid.*, p. 18.

<sup>14</sup> *Ibid.*, pp. 18, 20.

<sup>15</sup> Apart, that is, from changes in the discount rate. The judgment of the Presidents of the Federal Reserve banks at the hearings referred to above (especially pp. 20-22, 29) was that minor changes; e.g., from 3 to 3½ percent, have no significant effect on borrowing. An increase from 3 to 3½ percent, however, was presumed to be quite influential. Due acknowledgment was, of course, made to possible psychological effects and Mr. Hayes ascribed importance to the discount rate, somewhat obscurely, as "part of a total program" (p. 27). The question of the effect of changes in the discount rate lies outside the scope of the present paper which is concerned solely with administration of the discount window.



officials of the Reserve bank will then suggest to officers of the member bank that it is advisable for them to take steps to reduce their dependence on borrowing at the Federal Reserve. In the words of Mr. Hayes, "They always do."<sup>16</sup>

The description given by President Hayes of the process whereby Reserve officials restrain member banks from borrowing without ever actually refusing to lend is very similar to that outlined by his predecessor, Benjamin Strong, over 35 years earlier. Governor Strong described the technique as "educational," "to point out that certain kinds of loans should not be made."<sup>17</sup> The expression used by Robert Roosa, Vice President of the Federal Reserve Bank of New York, is similar but somewhat more grim, "we help a bank decide not to borrow from us."<sup>18</sup> It would appear that this phase of discount policy should best be regarded as a form of moral suasion.<sup>19</sup> The initiative in such a situation is with the Federal Reserve officials; i.e., the officers of the member bank do not obtain advance clearance as to whether or not they will be allowed to borrow.<sup>20</sup>

In the absence of prior warning by Reserve officials, the member bank can assume that its request for a loan will not be refused. There is the possibility of course, that this request, though granted, will be a factor in causing the Reserve authorities to intervene to discourage further loan requests. In such a situation it is fairly customary to indicate that reborrowing is not in order within a period of one or, preferably, more periods after existing notes mature or are paid off.

Some Federal Reserve banks have the reputation throughout the system of being stricter than others in their enforcement of the provisions of regulation A. Such differences appear, however, to have grown less in the past few years. On such major points as applying the same tests in periods of monetary ease or tightness and never refusing requests for loans there is uniformity throughout the system. Variations among Federal Reserve banks may reflect differences in the personal attitude of discount officers. In one district a bank might be expected to sell long Governments even in a falling market, if necessary in order to pay off an advance, while at another Reserve bank more time might be allowed. Differences may exist with respect to interpretation of what constitutes "continuous" borrowing. Some discount officers may be more lenient than others with respect to allowing a gradual scaling down of indebtedness over a series of dates as compared with an immediate payout.

The general impression one gets is that, by and large, the Reserve banks are disposed to be tolerant toward borrowing by banks whose resources are temporarily strained because of some understandable emergency or economic misfortune, such as a crop failure or period of drought. On the other hand, they are strongly opposed to allowing the resources of the Federal Reserve banks to be drawn upon to facilitate a member bank's speculating in Government bonds. The chief offenders appear to have been good-sized banks which bought Governments in the expectation of an appreciation in this price, and then turned to the Federal Reserve for advances rather than dispose of their holdings at a loss or without profit when a rise failed to materialize as had been anticipated.<sup>21</sup>

Precise data with respect to the administration of the discount window are closely guarded. Inquiries at a number of Federal Reserve banks, however, elicited information which suggests the general order of magnitudes involved. It seems that in a recent fairly active year approximately 20 percent of the member banks of the districts concerned had borrowed at one time or another during the year. The maximum number borrowing at any one time was a little less than half that figure. Banks discouraged from further borrowing amounted

<sup>16</sup> Hearings, p. 19.

<sup>17</sup> Joint Commission of Agricultural Inquiry, Hearings, pt. 13, 67th Cong., 1st sess., 1921, pp. 704-708.

<sup>18</sup> Hearings, p. 27.

<sup>19</sup> The Board of Governors has expressly included this aspect of discount policy under the broad definition of moral suasion. Cf. "U.S. Monetary Policy: Recent Thinking and Experience," Hearings, Subcommittee on Economic Stabilization, 83d Cong., 2d sess., 1954, p. 13. It is to be noted, however, that in this case the moral suasion is determined on the basis not of general credit conditions but of the operating practices of individual banks.

<sup>20</sup> Hearings, p. 23.

<sup>21</sup> In such cases borrowing is resorted to not in order to invest but in order to avoid disinvesting. The immediate need for additional reserves may be in order to accommodate rising loan demands by established customers of the bank. It may reflect a lack of adequate secondary reserves in the form of Treasury bills or other short-term assets (even where this means hanging on to such assets merely to preserve some ratio which the bank administration has come to look upon as sacrosanct). If the reserve deficiency is expected to be short, borrowing is a means of avoiding in-and-out expense.

to somewhat less than 1 percent of total membership in the districts. In at least one district a higher proportion of banks, roughly 2 percent, was admonished.

#### INTERACTION WITH THE TRADITION AGAINST BORROWING

The view is persistently maintained by certain of the Federal Reserve officials that administration of the discount window is a significant feature of overall credit control and not, as the foregoing description suggests, an adjunct to the supervisory function. In support of such a contention, Mr. Hayes has spoken of an "interaction" between open market operations and the use of the discount window.<sup>22</sup> The words in which the alleged interaction was described, however, seemed to put open market operations in the active role and to make discounting wholly passive, if not, indeed, something that may at times interfere with them.

"If you sell securities in the open market, other things being equal, you tend to put more pressure on the bank[s] and force them into the discount window to adjust their positions to come out evenly, and that per se, tends to put the banks under greater pressure."<sup>23</sup>

It seems clear from this description that the deterrent which makes it possible for open market sales to put pressure on banks is the tradition against borrowing and not the "use of the discount window." To the extent that borrowing takes place in spite of the tradition—which, as noted above, is freely open to member banks as long as they have not violated the standards laid down in regulation A—resort to the discount window interacts with open market operations not to support them but to provide an escape; i.e., to offset them!<sup>24</sup> It is extremely difficult to conjure out of this particular set of "interactions" a significant role for administration of the discount window as a positive element in the control of credit by the Federal Reserve.

It might be argued that the tradition against borrowing is sustained in a passive way by the language of regulation A. The law is broad enough, apparently, to enable the authorities to withdraw the privilege of discounting in the interest of stabilization if they should choose to do so. And it might perhaps be inferred that the feeling that this could be done is a deterrent to greater resort to the discounting privilege, lest this should lead to outright refusals of loan requests by the Reserve authorities. But any such inference would be no more than conjecture, and a rather farfetched conjecture at that.

A more significant possibility is that administration of the discount window, in the admonitory, moral suasion sense, has a tendency to strengthen the attitude of mind among bankers, "the instinct against borrowing," which is at the basis of the tradition. The tradition against borrowing presumably derives ultimately from a belief that continued borrowing may be interpreted as a confession either of weakened condition or of poor management.<sup>25</sup> In any case, the experience of being cautioned against undue borrowing is one which a commercial banker does not relish. In such a relationship he is accustomed to appearing in the opposite role. To be admonished is likely to seem embarrassing and even humiliating. Thus the mere fact that the borrowing activities of bankers are occasionally called into question by officials of the Federal Reserve may help to keep the tradition against borrowing alive and at times to strengthen it.

An example of a refurbishing of the tradition against borrowing is to be found in the recent experience of one of the Midwest Federal Reserve banks. For some years this district had been conspicuous for the relatively high proportion of borrowing by its member banks. The conclusion was reached that this continuing feature was not sufficiently accounted for by agricultural difficulties or other economic characteristics of the area. It was decided that the question of undue borrowing had not been brought sufficiently to the attention of the bankers of the district. Accordingly, a deliberate educational program was

<sup>22</sup> Hearings, p. 19.

<sup>23</sup> *Ibid.*

<sup>24</sup> In some instances a better figure is that of a safety valve. Borrowing may appropriately occur as a means of cushioning the uneven impact of such general instruments as open market sales and increases in reserve requirements. It is a means whereby banks which have been squeezed by the reduction in reserves can obtain temporary relief. Cf. Board of Governors, Annual Report for 1957, pp. 12-13.

<sup>25</sup> Large banks are said to be less reluctant than smaller banks to borrow from the Federal Reserve. A possible explanation of this difference is that large banks are likely to feel sufficiently sure of themselves not to fear such an invidious interpretation of their action in borrowing. It may, perhaps, be conjectured that the growing strength of banks, carrying with it heightened self-confidence of bankers, will have a tendency over the years to weaken the force of the tradition against borrowing.

undertaken by the Reserve bank officials to explain the system's attitude toward member bank borrowing.<sup>26</sup> An effort was made to differentiate between desirable and undesirable borrowing. An added note of formality was introduced into the borrowing procedure by the use of application forms and by requiring banks to submit condition statements at each reserve period when they found themselves in debt to the Federal Reserve. So successful was the campaign to rehabilitate the tradition that the ratio of borrowing in the district fell to one of the lowest in the system.<sup>27</sup>

#### CONCLUSION

For the overwhelming majority of member banks, those which are not in contravention of the relatively narrow provisions (as applied) of regulation A governing discounts, the privilege of borrowing, despite conventional statements to the contrary, is, in practice, tantamount to a right. At a time of general overexpansion of credit, an increasing number of banks would doubtless cross the line of tolerance at which borrowing is frowned upon as being excessive in amount or too continuous. In any situation that can realistically be imagined, however, there would still be a great many banks whose record was clear. Under longstanding practice, these banks could count on being able to obtain credit by borrowing at the Reserve banks whenever they so desired.

During the business boom of 1955-57 the Economic Report of the President declared that "The pressure on reserves induced member banks, despite an increased discount rate, to borrow more heavily from the Federal Reserve."<sup>28</sup> Despite such testimony as this, there is no significant evidence that resort to discounting, whether it is called a privilege or a right, has been on such a scale as to weaken appreciably the efforts of the Reserve authorities to tighten credit. That this has not occurred is apparently strongly influenced by the tradition against borrowing.<sup>29</sup> Thus the Federal Reserve has been able, mainly by open market sales or by refraining from purchases in the face of growing demands, to tighten reserves without having their efforts seriously hampered by undue resort to member bank borrowing. It is not, however, the refusal of loans at the discount window that makes this possible but the forbearance of member banks from requesting advances, even though they are perfectly free to do so.

The discount window as presently administered is perhaps no more than a paper threat to the power of the Federal Reserve to control credit. Potentially, however, the discount window is an avenue of escape from the limitations of Federal Reserve credit policy because of the ability of the vast majority of member banks to obtain reserves on their own initiative if they should choose to do so.

Under one interpretation, the discount window may be looked upon as an "engine of inflation" which remains stalled not because of the control exercised by the Reserve banks but because of the complaisance of the member banks. Under a different interpretation, it could be viewed in the light of a very efficient police system which is seldom called upon to make an arrest. The truth may be somewhere between these two interpretations. Fortunately, there is nothing to indicate that the present situation cannot go on indefinitely.

Whether or not the discount window is to be viewed as a potential threat to Federal Reserve credit control, it surely does not deserve, as presently administered, to be regarded as a direct factor in the exercise of such control. The

<sup>26</sup> A senior officer of one of the Federal Reserve banks listed the following as justifiable reasons for borrowing from the Fed:

- (a) Reserve adjustment, as where a city bank experiences a sudden, short-period drain of reserves.
- (b) Seasonal need beyond what can reasonably be anticipated and prepared for.
- (c) Economic distress, as in the case of crop failure or work stoppage in a one-industry community.

Another officer gave as the usual reason for undue borrowing the attempt of the particular banker to "run a bigger bank than he has got." The aim of the Federal Reserve was described by one discount officer as being to "get them out, not keep them out." Cf. also Karl R. Bopp, "Some Basic Principles," Business Review, Federal Reserve Bank of Philadelphia, June 1958, pp. 6-7.

<sup>27</sup> Because bankers are great traditionalists, practices to which they are accustomed tend to be perpetuated. The tradition against borrowing when once reestablished is not readily reversed. This fact would interfere with use of discount policy as an anticyclical instrument.

<sup>28</sup> January 1956, p. 6.

<sup>29</sup> The fact that a rise in member bank borrowing generally occurs when an increase in the financial inducement is provided by significantly higher market rates suggests that the tradition is far from binding. It may be that what we have is a tradition against borrowing except when the spread between discount and market rates is sufficiently attractive to make them want to do so. Certainly a significant widening of the spread greatly increases the attraction of borrowing from the Federal Reserve banks.

chief influence of the administration of Federal Reserve loan operations may well be indirect, viz, that of helping to keep alive and reinforce the tradition against borrowing, without which discount policy as presently conducted could quickly break down.

There was a time during and after World War I when member bank borrowing at the Federal Reserve exceeded total reserve balances, part of the time by a substantial amount. It could then be said that member banks operated entirely on borrowed reserves. Various developments have tended to reduce the importance of borrowing as a source of reserve balances. The longer reserve averaging period has made banks somewhat less dependent on the discount window.<sup>30</sup> The rise of the Federal funds market has provided individual banks with a convenient means of obtaining additional reserves when needed. So also have the large holdings of short-term Treasury obligations. It is still true, no doubt, that discounting offers a number of not inconsiderable advantages.<sup>31</sup> But for the time being, at least, discounting and the direct control exercised through the discount window possess little of the strategic importance still customarily ascribed to them.

UNIVERSITY OF PENNSYLVANIA.

<sup>30</sup> Federal Reserve Bank of Boston, "The Federal Funds Market" (Boston, 1957), pp. 15-16.

<sup>31</sup> Cf. Federal Reserve Bank of Kansas City, "Monthly Review," February 1958, p. 5. Also Walker, *op. cit.*, pp. 225-230.

