



# Working Paper Series



This paper can be downloaded without charge from:  
<http://www.richmondfed.org/publications/>



**THE FEDERAL RESERVE BANK OF RICHMOND**  
RICHMOND ■ BALTIMORE ■ CHARLOTTE

Working Paper 90-7

WICKSELL'S MONETARY FRAMEWORK  
AND DYNAMIC STABILITY

Robert F. Graboyes  
and  
Thomas M. Humphrey

Federal Reserve Bank of Richmond

September 1990

The views expressed here are solely those of the authors and do not necessarily reflect the views of the Federal Reserve Bank of Richmond or the Federal Reserve System.

## INTRODUCTION

Traditionally, central banks seeking to stabilize general prices have followed policies similar to those advocated by Knut Wicksell: when prices are higher than desired, raise interest rates to exert downward pressure on prices, and conversely. Despite the historical predominance of interest rate-based monetary policies, analysts frequently focus on how prices are affected by control of the money stock (or its high-powered base). In those cases where they do examine the relationship between interest rates and prices, they mostly do so in a Keynesian framework rather than a Wicksellian one. For several reasons, Wicksell's analysis deserves renewed attention. Here, we examine whether his interest rate-adjustment rule, coupled with his famous cumulative process mechanism of price level change, can stabilize prices (and interest rates). We find that if the interest rate rule is properly specified, it can.

Wicksell's cumulative process analysis assumes the existence of two real interest rates: the bank lending rate and the equilibrium or natural rate corresponding to the marginal productivity of capital. He did not distinguish between real and nominal rates; no expected inflation premia enter his analysis. Wicksell believed prices rose (fell) when the bank rate was below (above) the natural rate. By contrast, Keynesian IS-LM models assume only one real interest rate, namely the one that simultaneously equilibrates the goods and money markets.

Wicksell's analysis is of timely importance. For the past three decades, the goal of price stability has been seen by many as conflicting with the goals of robust real activity and strong growth, at least in the short run. Now, the notion of a stable price level is once again within the bounds of serious policy debate. This much is evident in the attention being given the Neal Resolution which would require the Fed to eliminate inflation within five years<sup>1</sup>.

Wicksell's logic is as familiar as the daily business pages: interest rates set "incorrectly" lead to inflation or deflation, so if prices are rising or falling, use interest rates as an instrument to stop their movement and return them to their fixed target level. The central question here is whether this logic can translate into a practical policy rule capable of delivering price stability.

## I. PRICE STABILITY VS. ZERO INFLATION

Wicksellian Price stability is not just the absence of persistent inflation, but also the absence of price level drift. The Neal Resolution requires that the Federal Reserve attain "zero inflation" within five years of passage. It goes farther, saying:

---

<sup>1</sup> For a discussion of the Neal Bill, see Black (1990).

inflation will be deemed to be eliminated when the expected rate of change of the general level of prices ceases to be a factor in individual and business decisionmaking;

Compare this with Wicksell's definition of price stability:

the problem of keeping the value of money steady, the average level of money prices at a constant height ... evidently is to be regarded as the fundamental problem of monetary science ... (Wicksell, 1907. p. 553)

These two definitions are close in meaning. The price level only ceases influencing the real economy when no one expects the return on effort or investments to be affected by changes in the price level. There is a view which holds that policymakers should be content merely to halt inflation at a higher price level rather than roll back prices to their pre-inflation level.

Whatever the merits of this argument, it does not accord with Wicksell. Expected upward price shocks will discourage investment in long bonds or fixed income pensions just as surely as will expected continual inflation. To Wicksell, the ultimate goal of monetary policy was to remove the general price level from decisions about investment and production. He was aware that merely stopping inflation once it starts without rolling back prices to some fixed target level gives politicians strong incentive to tax through price rises because they need never fear that a future deflation will remove the proceeds of the tax.

After a long absence, the notion of Wicksellian price stability has returned to the realm of policy debate. Because monetary authorities have consistently favored interest rates over the monetary base as a policy tool, it is a good idea to

know whether Wicksell's mechanism can, in fact, achieve its desired end.

Unfortunately, Wicksell does not provide easy proof of the efficacy of his policy recommendations. Though he was a trained mathematician, Wicksell wrote his price stabilization analysis in prose, not in equations. The translation of his prose into mathematics is not always straightforward nor entirely consistent from one passage to another.

Wicksell was clearest in explaining how prices respond to deviations of the bank rate from the natural rate of interest. He was not so clear in his statement of the interest rate rule the monetary authorities should follow to achieve price stability. Due to its ambiguity, Wicksell's writing can be read in different ways. Accordingly, the remainder of this paper looks at five different two-equation inflation models, each using a different interpretation of Wicksell's interest rate rule. The first three models exhibit price instability. By contrast, the final two models deliver full price stability.

The first model, from a paper by Federal Reserve Board economists Jeff Fuhrer and George Moore, gives an initially plausible (though, we feel, doctrinally inaccurate) two-dimensional version of Wicksell's system. We feel this model accords with many current observers' interpretation of Wicksell's

policy prescription. The remaining four models are of our design, all four sharing the same price adjustment equation, and differing only in the way we specify the interest rate reaction function. The paper is organized as follows:

**Model #1 (Fuhrer and Moore's):** Here, the rate of inflation (not the level of prices) responds to deviations of the real interest rate from the natural rate. Interest rates are adjusted to keep the inflation rate (not the level of prices) at a target level. The result is an explosive system.

**Model #2:** Monetary authorities adjust bank interest rates in response to deviations of the price level from its desired target level. This rule anchors the price level, on average, but permits perpetual oscillations of constant amplitude about that average level.

**Model #3:** Monetary authorities adjust bank rates in response to price changes, not to gaps between actual and target price levels. This rule always halts price movements at a different price level than prevailing before.

**Model #4:** Here, monetary authorities adjust bank rates in response to *both* price gaps *and* price movements. Under this rule, interest rate adjustments alternate between strong and weak in response to deviations from the price level. This version is algebraically cumbersome, but provides an intuitive geometric analysis.

**Model #5:** Again, monetary authorities respond to *both* price gaps *and* to price movements. This version is analytically simpler than Model #4. Under this rule, the strength of interest rate changes is the *sum* of changes under the rules in Models #1 and #2.

**Appendix:** As much as possible, the mathematical analyses are relegated to the Appendix.

## II. MODEL #1: FUHRER AND MOORE'S FIRST MODEL

In this model, the rate of inflation rises when the market interest rate falls below the natural rate. The central bank then

adjusts the market rate in response to deviations from the policymakers' target inflation rate. This model proves to be dynamically unstable -- adjusting the market interest rate to counter undesired movements in the inflation rate destabilizes the inflation rate rather than stabilizing it. Both inflation and interest rates either rise monotonically or rise and fall in cycles of increasing amplitude. Following, in our notation, are Fuhrer and Moore's two equations:

$$(1) \quad \dot{\pi}_t = \alpha[\bar{r} - \{r_t - \pi_t\}]$$

$$(2) \quad \dot{r}_t = \beta[\pi_t - \pi_T]$$

where

$r$  = the nominal interest rate (which Fuhrer and Moore identify as the Fed Funds rate)  
 $\dot{r}$  =  $dr/dt$ : change in nominal interest rates  
 $\pi$  = the inflation rate  
 $\pi_T$  = the target inflation rate  
 $\dot{\pi}$  =  $d\pi/dt$ : change in the inflation rate  
 $\bar{r}$  = the natural rate of interest (unobservable)

$\alpha, \beta$  are parameters,  $\beta$  being the monetary policy control variable.

On historico/doctrinal grounds, we have several objections to this interpretation of the Wicksellian system:

[1] Including the inflation rate as an argument in equation (1) assumes a Fisher effect (an inflation premium in nominal interest rates). Wicksell was a contemporary of Irving Fisher's, but incorporated no such effect in his thinking.



[2] It is because the model is stated in inflation rates rather than in price levels that there is a Fisher effect. With only transient deviations from the target price level, the Fisher effect would be of little or no importance.

[3] It is this non-Wicksellian element (an inflation premium in nominal interest rates) that causes the model to be dynamically unstable. Dropping the inflation premium  $\pi$  from equation (1) yields not the monotonically explosive path for prices (or inflation) and interest rates found by Fuhrer and Moore, but rather a cyclical path of constant amplitude. (see Appendix, i and ii).

### III. STABILIZING WICKSELL'S MODEL

In this section, we present four alternative interpretations of the Wicksellian system, each represented by a two-equation model. We believe our price-change equation [equation (3)] is correct and can be derived unambiguously from Wicksell's own complete structural model of the inflationary process (see Appendix iii). And we believe Wicksell formulated at least two alternative versions of his monetary policy rule and not just the single version suggested by equation (2).

#### III.1 Model #2

We begin by eliminating the Fisher Effect from equation (1) and by directing the policymakers to achieve a target price level

rather than a target rate of inflation. In equation (3), prices rise (fall) when market interest rates are above (below) the natural rate of interest. In equation (4), policymakers raise (lower) market interest rates when the price level is above (below) the target level.

$$(3) \dot{p}_t = \alpha[\bar{r} - r_t]$$

$$(4) \dot{r}_t = \beta[p_t - p_T]$$

where

$p$  = the price level  
 $\dot{p}$  = changes in the price level  
 $p_T$  = the target price level

The Appendix (iii) shows how reduced-form equation (3) is derived from Wicksell's complete structural model of the inflation process. Equation (4) is equivalent to equation (2), except the arguments are price levels rather than inflation rates.

In his writings, Wicksell alternates between adjusting the market rate in response first, to price *movements*, and second, to *gaps between actual and target price levels*. In so doing, he leaves doubts as to the exact specification of his monetary policy rule. In a fuller version of the passage quoted on page 3 above, he seems to favor a policy rule targeting the price level:

[Under a fiat paper standard,] the problem of keeping...the average level of money prices at a constant height, which evidently is to be regarded as the fundamental problem of monetary science, would be solvable [through] proper regulation of general bank-rates, lowering them when prices are getting low, and raising them when prices are getting high. (Wicksell,

1907, pp. 553)

Wicksell's wording is ambiguous; it is unclear whether interest rates should respond to the price level (relative to the target) or to the *direction of change* of the price level. Our examination of the full quote leads us to believe that Wicksell meant that monetary authorities should focus on the price level, as shown in equation (4). In other words, we interpret "prices are getting low" to mean the price level is below the target, rather than meaning that prices are declining. Evidence supporting this interpretation comes from page 223 of the second volume of his *Lectures on Political Economy*. There, he refers to a policy consisting of "a raising or lowering of bank rates ... in order to depress the commodity price level when it showed a tendency to rise and to raise it when it showed a tendency to fall." Obviously, he means that prices should be *rolled back* to their former levels after inflation is stopped. On the other hand, quotes from Wicksell's other writings appear to lean toward adjusting rates in response to inflationary and deflationary price changes, such as the rule shown in equation (5); one such quote is the following:

So long as prices remain unaltered, the banks' rate of interest is to remain unaltered. If prices rise, the rate of interest is to be raised, and if prices fall, the rate of interest is to be lowered... (Wicksell, 1898, p. 189)

Unlike Fuhrer and Moore's equations (1) and (2), equations (3) and (4) do not result in an explosive system, though neither

is the system stable in a strong sense. Rather, the system yields perpetual oscillations about equilibrium with no convergence toward it. From any point, the path through  $(r,p)$ -space will follow one of a family of geometrically similar, endless ellipses as shown in Figure 1. In other words, prices will cycle ceaselessly about their target equilibrium level, and market interest rates will cycle about the natural rate. True, prices are stable on average over the whole cycle, but they are forever rising and falling. The same is true of interest rates. Such is not the sort of stability Wicksell envisioned.

### III.2 Model #3

If Wicksell intended for the monetary authorities to respond to price *changes*, rather than to deviations from the target price level, then his model would be composed of equations (3) and (5), below.

Equation (3), repeated here, says that prices rise (decline) if the market interest rate is below (above) the natural rate. Equation (5) says that policymakers should raise (lower) market interest rates proportionally with the rise (drop) in the price level.

$$(3) \dot{p}_t = \alpha[\bar{r} - r_t]$$

$$(5) \dot{r}_t = \gamma \dot{p}$$

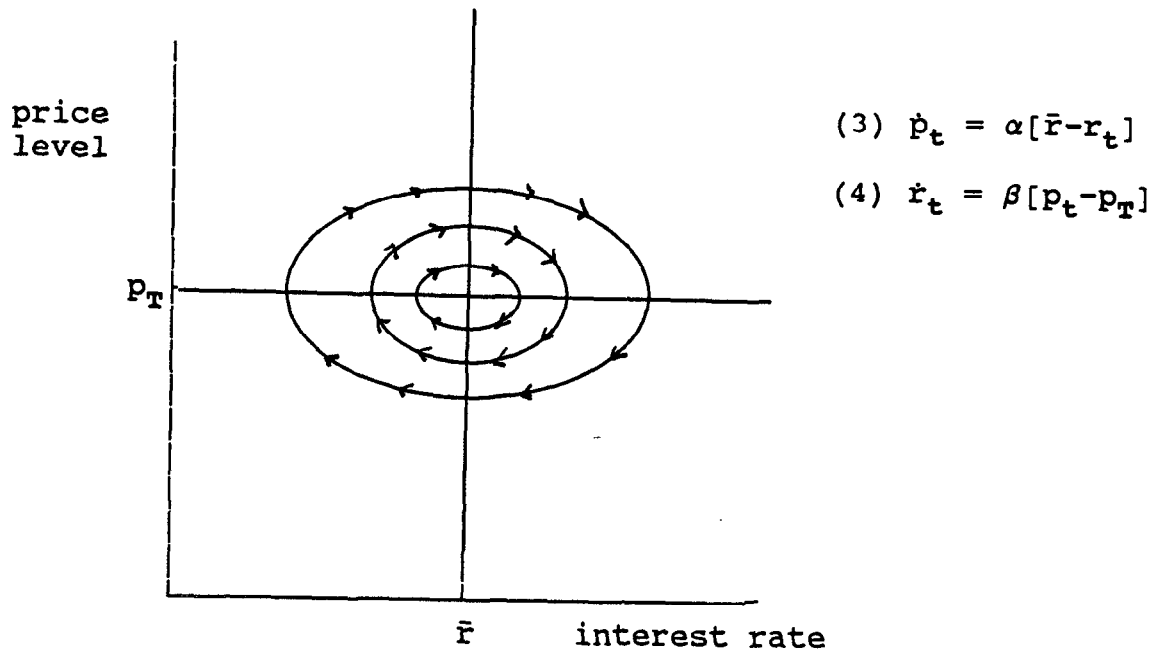
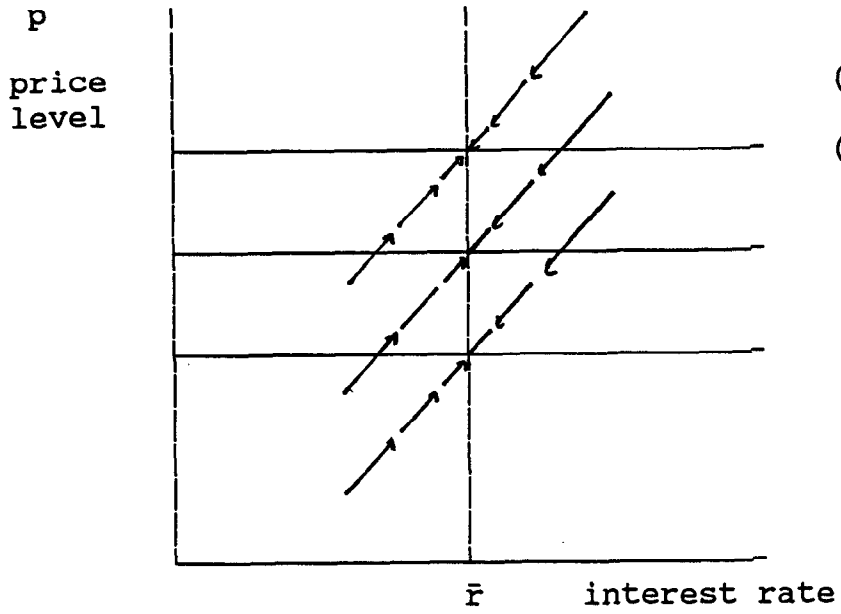

Figure 1

Substituting equation (4) into equation (5) gives equation (5'), which says that the change in market interest rates is proportional to the difference between the market interest rate and the natural rate. This formulation can be depicted in the phase diagram of Figure 2a. For practical policy purposes, however, central bankers must rely on (5), since (5') contains the unobservable natural rate and is therefore nonoperational.

$$(5') \quad \dot{r}_t = \gamma\alpha(\bar{r}-r)$$

By adjusting the market rate in the same direction that prices are moving, this rule eventually halts such movements and brings price changes to a standstill. The system reaches a new equilibrium price level and interest rate (see Figure 2a). But, the new equilibrium price level is not the same as the preexisting one. For example, in Figure 2b, assume that a real economic shock causes the natural rate to shift from  $\bar{r}$  to  $\bar{r}'$ , thus introducing a divergence between the market and natural rates. Prices begin rising, so the monetary authorities respond by raising the market rate. Eventually, price movements will cease at the new equilibrium price level  $p'$ . This upward drift in the price level violates the notion of absolute price stability and contrasts sharply with Wicksell's statement that the "fundamental problem of monetary science" is to stabilize the price level.



$$(3) \dot{p}_t = \alpha[\bar{r} - r_t]$$

$$(5) \dot{r}_t = \gamma \dot{p} = \gamma \alpha (\bar{r} - r_t)$$

Figure 2a

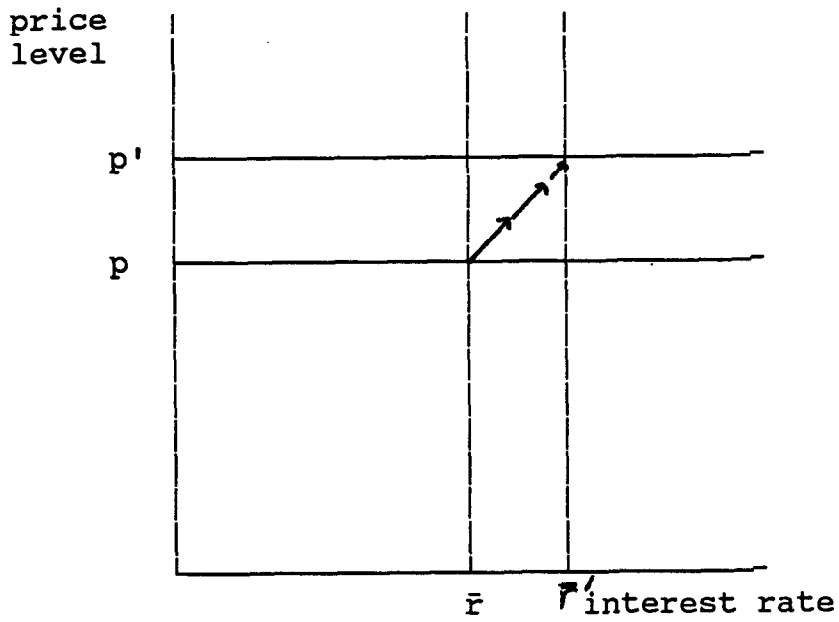

Figure 2b

The model composed of equations (3) and (4) "stabilizes" the price level (on average) but produces a perpetual cycling of prices and interest rates. In the alternative model composed of equations (3) and (5), inflation or deflation disappear over time, but the equilibrium price level can drift about, anchorless. Wicksell was clearly concerned both with attaining zero inflation and with stabilizing the price level, so it is unlikely that he would be satisfied with either of these policy rules.

### III.3 Model #4

A clue to how one might make the model stable (in the sense of always returning prices to a fixed target level) can be found in the geometry of the system formed by equations (3) and (4). Figure 3a shows a family of paths through  $(r,p)$ -space, given the parameters  $\alpha$  and  $\beta(=\beta_1)$ . The "flatness" of the ellipse is an increasing function of the ratio  $\beta/\alpha$ . Therefore, assuming  $\alpha$  is unchanged, Figure 3b shows a family of paths where  $\beta=\beta_2<\beta_1$ , so the ellipses are less flat in Figure 3b than they are in Figure 3a.

One way to stabilize the model is to incorporate a switching rule that directs policymakers to switch back and forth between two values of  $\beta$ . Consider the four quadrants formed by the  $p_T$  and  $\bar{r}$  lines. In the northwest quadrant, two problems exist: prices



(3)  $\dot{p} = \alpha[\bar{r} - r_t]$   
 (4)  $\dot{r} = \beta_1[p - p_T]$

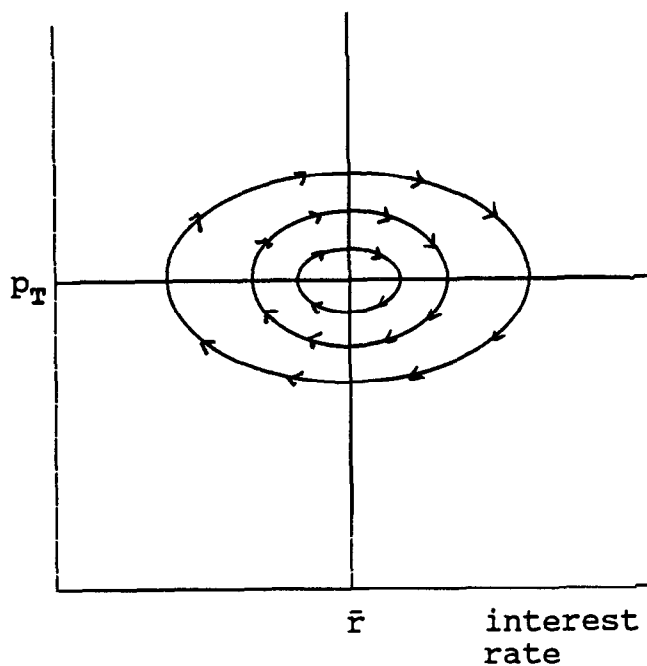

Figure 3a

(3)  $\dot{p} = \alpha[\bar{r} - r_t]$   
 (4)  $\dot{r} = \beta_2[p - p_T]$   
 where  $\beta_2 < \beta_1$

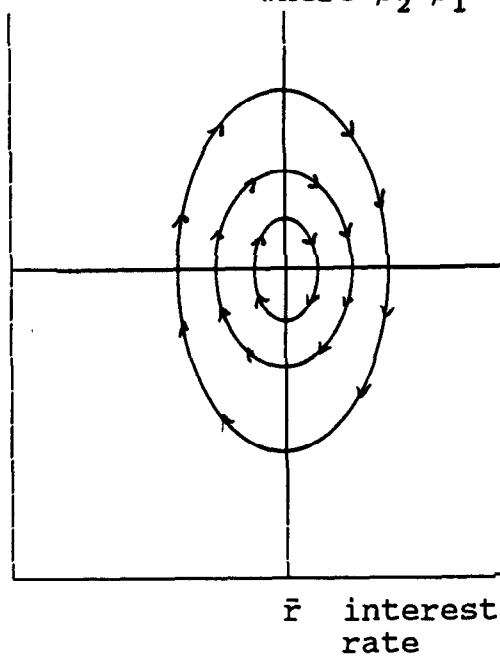
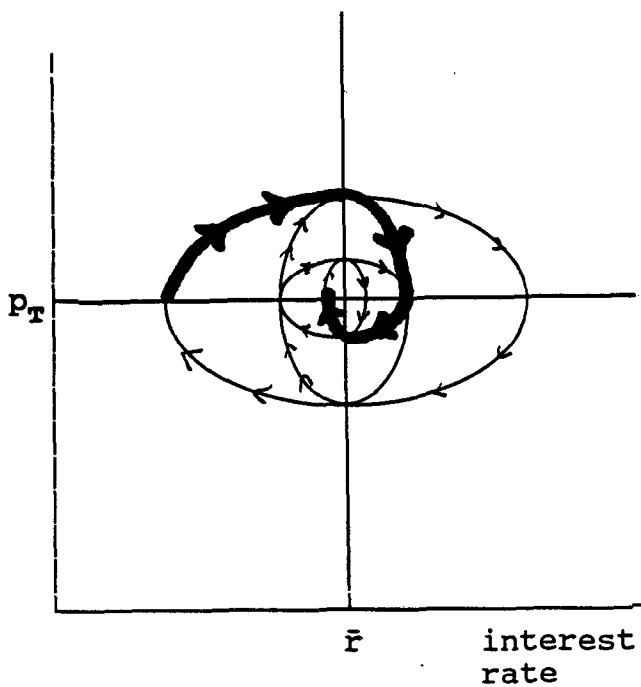

Figure 3b



$\dot{p} = \alpha[\bar{r} - r]$   
 $\dot{r} = \beta_1[p - p_T]$  in NW & SE  
 $\dot{r} = \beta_2[p - p_T]$  in NE & SW

Figure 3c

are above the target level and they are rising even higher. Moving into the northeast quadrant, prices are still too high, but they are declining toward the target level. Similarly, there is a double problem in the southeast quadrant (prices too low and getting lower) but only one problem in the southwest (prices too low). Intuitively, this suggests a new policy rule: the monetary authorities should react strongly ( $\beta$  relatively high) in the northwest and southeast quadrants, and they should react less strongly ( $\beta$  relatively low) in the northeast and southwest. In other words, the strength of the interest rate response should depend on whether the deviation from the target price level has the same sign as the direction of price changes. Algebraically, this rule can be represented as follows:

$$(6) \quad \dot{r} = \beta(p, \dot{p}) \cdot (p - p_T)$$

$$\text{where } \beta[\text{sgn}(p - p_T) = \text{sgn}(\dot{p})] > \beta[\text{sgn}(p - p_T) \neq \text{sgn}(\dot{p})]$$

In Figure 3c, the time paths shown in 3a and 3b are superimposed. By switching the monetary policy reaction parameter each time  $\bar{r}$  or  $p_T$  is passed, movement switches back and forth between the two families of ellipses. Such switching leads to an orbit (shown in bold) that decays inward toward the equilibrium. Of course policymakers can't observe the natural rate  $\bar{r}$ , so they use the direction of price change as a proxy to signal when to change  $\beta$ .

### III.4 Model #5

Another version of the preceding model is produced by allowing both the gap between actual and target price levels and the change in prices to enter the policy rule additively. Now, the change in interest rates equals the sum of changes under equations (4) and (5). The complete system now consists of equations (3) and (7):

$$(3) \dot{p}_t = \alpha[\bar{r} - r_t]$$

$$(7) \dot{r} = \beta(p - p_T) + \gamma\dot{p}$$

Note that the right-hand side of equation (7) consists of two terms. The last term  $\gamma\dot{p}$  directs the policymakers to adjust the market rate to halt the price change. The first term  $\beta(p - p_T)$  directs them to undo damage already done by rolling back prices to target. In other words, equation (7) says that market rates should be adjusted both to arrest and to reverse price changes.

This model yields a dynamically stable solution [see Appendix for proof]. Moreover, the rule is operational, and rather than being saddlepoint stable, will cause the system to converge to equilibrium from any point, as long as  $\alpha$ ,  $\beta$ , and  $\gamma$  are positive. To map out a phase diagram, as in Figure 4, we substitute equation (4) into equation (7), yielding:

$$(7') \dot{r} = \beta(p - p_T) + \gamma\alpha(\bar{r} - r)$$

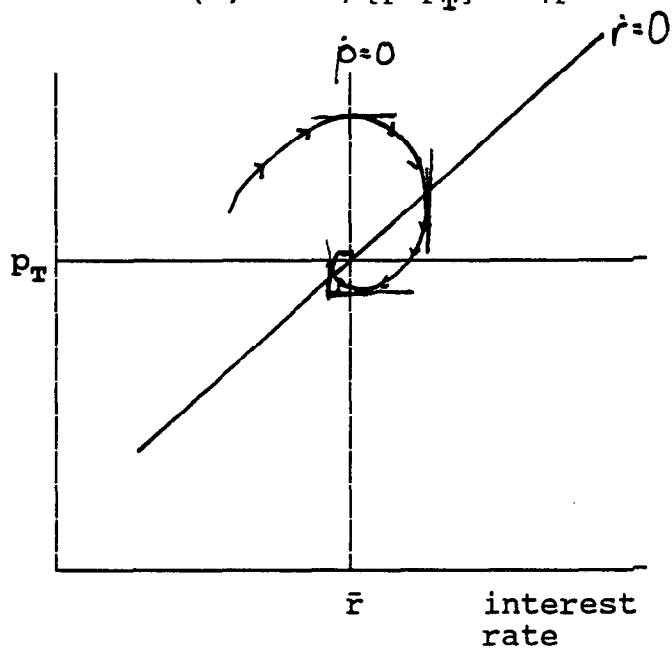

Figure 4

## V. Conclusion

We have shown that Wicksell's simple two-equation model can yield dynamic stability such that policymakers can always restore prices to target. However, this result requires a fully specified version of the policy response function. That particular response function requires authorities to adjust the market rate of interest in response to two variables, namely the price gap  $p-p_T$  and the movement or change in prices  $dp/dt$ . Previous versions of the policy rule have incompletely specified Wicksell's policy response function, calling for policymakers to react to one variable or the other, but not to both. Since neither variable alone is sufficient to ensure stability, it is not surprising that Wicksell's model has been judged dynamically unstable by some observers. A close reading of Wicksell, however, suggests that while he postulated two separate policy reaction or interest-rate adjustment functions -- one containing the price gap  $p-p_T$  as an argument and the other containing  $dp/dt$  -- he never took the final step of incorporating both in a single function. Apparently realizing that a price-change feedback rule would not stabilize the price level, he then postulated the price-gap feedback rule, evidently thinking the latter rule would stabilize prices. He did not realize that both the price-change and price-gap variables were necessary to render the feedback rule powerful enough to stabilize prices. Though Wicksell never explicitly recommended incorporating both variables into a single

policy reaction function, we can do so here without having to look beyond Wicksell's own words.

## APPENDIX

## i. Why Model #1 Explodes

Formal analysis of the model's stability properties requires expressing it in matrix form and then examining the signs of the determinant and the trace of the coefficient matrix. In matrix notation, Fuhrer and Moore's two equation system [equations (1) and (2)] is:

$$(A.1) \quad \begin{bmatrix} \dot{\pi} \\ \dot{r} \end{bmatrix} = \begin{bmatrix} \alpha & -\alpha \\ \beta & 0 \end{bmatrix} \begin{bmatrix} \pi \\ r \end{bmatrix} + \begin{bmatrix} \alpha \bar{r} \\ -\beta \pi_T \end{bmatrix}$$

Stability of equilibrium requires that the determinant of the coefficient matrix be positive and the trace negative. This model passes the first test, but not the second. The determinant of the coefficient matrix  $\beta\alpha$  is positive, but the trace  $\alpha$  is positive, not negative. A positive determinant and positive trace can mean two things: Either [1] the roots of the system's characteristic equation are real and positive implying monotonically explosive paths; or [2] the roots are imaginary with real parts positive, implying explosive cycles. Either way, the system diverges progressively from equilibrium. If the trace were zero, the system would orbit ceaselessly, but not explosively. The trace  $\alpha$  consists of the coefficient on the inflation rate in the price response equation. That inflation-

rate variable is only present because Fuhrer and Moore have assumed, contrary to Wicksell, the existence of a Fisher Effect. In other words, without that assumption, the system would not explode.

**ii. Why Model #2 Yields a Steady, Nonconvergent Ellipse**

Model #2 [equations (3) and (4)] is shown here in matrix form:

$$(A.2) \quad \begin{bmatrix} \dot{p} \\ \dot{r} \end{bmatrix} = \begin{bmatrix} 0 & -\alpha \\ \beta & 0 \end{bmatrix} \begin{bmatrix} p \\ r \end{bmatrix} + \begin{bmatrix} \alpha \bar{r} \\ -\beta p_T \end{bmatrix}$$

Here, we use the price level instead of the inflation rate. As in (A.1), the determinant of the coefficient matrix is positive. However, since the matrix contains no term equivalent to Fuhrer and Moore's Fisher Effect, the trace is zero, so this system loops around endlessly, neither damping nor exploding. Following is a more intuitive geometric exposition:

To find the slope, or direction of motion at a given point, we divide Equation (3) by Equation (4), so that:

$$(A.3) \quad \dot{p}/\dot{r} = dp/dr = [\alpha(\bar{r}-r)]/[\beta(p-p_T)]$$



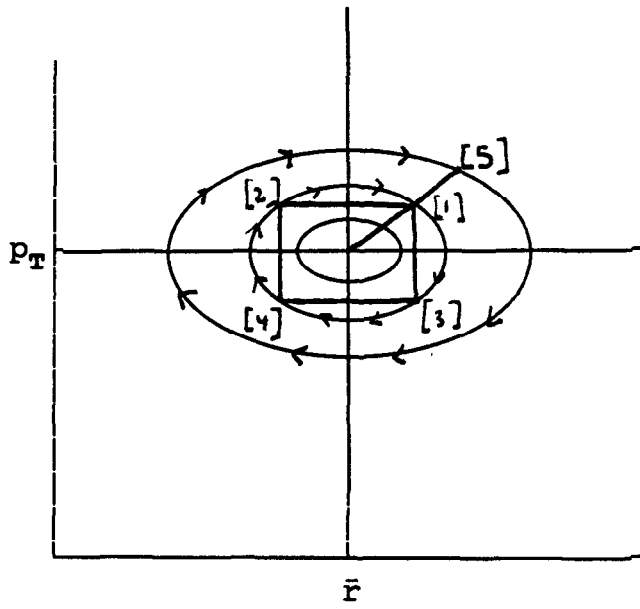

Figure A.1

In Figure A.1, point [1] is arbitrarily chosen. Points [1] and [2] are equidistant from the vertical line at  $\bar{r}$ . Points [1] and [3] are equidistant from the horizontal line at  $p_T$ , as are points [2] and [4]. Thus, these four points form a rectangle which is symmetric with respect to the lines intersecting at the equilibrium point. Algebraically, these points are: [1]  $(r, p)$ ; [2]  $(2\bar{r}-r, p)$ ; [3]  $(r, 2p_T-p)$ ; and [4]  $(2\bar{r}-r, 2p_T-p)$ . Evaluating Equation (A.3) at any of these four points, the absolute value of  $dp/dr$  is the same. That is, the phase diagrams are symmetrical across the  $\bar{r}$  and  $p_T$  lines. A upward path in the NW quadrant (defined by these two lines) will be mirrored in the downward path through the NE quadrant, and so on. Further, the family of ellipses are geometrically similar. This is true because for  $\phi > 0$ , the slope at [5]  $(\bar{r} + \phi(r - \bar{r}), p_T + \phi(p - p_T))$  is the same as at [1].

### iii. Wicksell's Full Structural Model of Price Stabilization

The two-equation model  $dp/dt = \alpha(\bar{r}-r)$  and  $dr/dt = \beta(p-p_T) + \gamma(dp/dt)$  [equations (3) and (7)] is but the condensed or reduced-form version of Wicksell's complete structural model of the inflationary process -- his famous cumulative process model. The purpose of this section is to spell out that model in some detail.

Wicksell's cumulative process model assumes full employment and describes the interaction of the markets for goods, credit, and money. The model consists of 13 equations linking the

variables investment  $I$ , saving  $S$  (both planned or ex ante real magnitudes), market (loan) rate  $r$ , natural rate  $\bar{r}$ , loan demand  $L_D$ , loan supply  $L_S$ , excess supply of money  $X$ , excess aggregate demand  $E$ , money-stock change  $dM/dt$ , price-level change  $dp/dt$ , and market rate change  $dr/dt$ . Of these, saving and investment are taken to be increasing and decreasing linear functions of the market rate of interest, the presumption being that higher rates encourage thrift but discourage capital formation.

Equation A.3 states that real investment  $I$  exceeds saving  $S$  when the market rate of interest falls below its natural equilibrium level  $\bar{r}$  (the level that equilibrates saving and investment):

$$(A.4) \quad I - S = a(\bar{r} - r)$$

Here the coefficient  $a$  relates the investment-saving gap to the rate differential that creates it. Since Wicksell assumed that banks lend only to investors and that all investment is financed by bank loans, equation (A.5) states the (investment) demand for loans  $L_D$  as:

$$(A.5) \quad L_D = I(r)$$

where  $I(r)$  is the schedule relating desired investment spending to the market or loan rate. Equation (A.6) expresses loan supply

$L_s$  as the sum of household saving  $S(r)$ --all of which Wicksell assumes is deposited in banks--plus new money  $dM/dt$  created by banks in accommodating loan demands:

$$(A.6) \quad L_s = S(r) + dM/dt.$$

Equation (A.7) states the market-clearing condition in the credit market (i.e., the market for bank loans):

$$(A.7) \quad L_D = L_s.$$

Substituting (A.5) and (A.6) into (A.7) yields:

$$(A.8) \quad I - S = dM/dt$$

which says that, assuming banks create money by way of loan, monetary expansion occurs when they lend more to investors than they receive in deposit from savers. Thus the investment-saving gap is matched by new money created to finance it.

But since the demand for money to hold at existing prices and real incomes has not changed, the newly created money  $dM/dt$  represents an equivalent excess supply of money  $X$  according to the expression

$$(A.9) \quad dM/dt = X.$$

Cash-holders then attempt to get rid of their excess cash holdings by spending them on goods. As a result, the excess supply of money  $X$  then spills over into the commodity market in the form of an excess demand  $E$  for goods as aggregate expenditure at full employment outruns real supply:

$$(A.10) \quad X = E.$$

This excess demand bids up prices, which rise by an amount  $dp/dt$  proportionate to the excess demand,

$$(A.11) \quad dp/dt = kE.$$

Substituting equations (A.4), (A.8), (A.9), and (A.10) into (A.11) yields:

$$(A.12) \quad dp/dt = ka(\bar{r}-r)$$

or

$$(A.12') \quad dp/dt = \alpha(\bar{r}-r) \text{ where } \alpha = ka.$$

Equation (A.12') says that price-level changes stem from the discrepancy between the natural and market rates of interest. Adding the interest-rate adjustment or policy-reaction function

$$(A.13) \quad dr/dt = \beta(p-p_T) + \gamma(dp/dt)$$

yields the second reduced-form equation of Wicksell's model.

In sum, equations (A.4)-(A.13) constitute the full structural model underlying the reduced-form model consisting of equations (A.12') and (A.13).

#### iv. Stability of Wicksell's Rule #4

Wicksell System #4, composed of equations (3) and (7), is represented here in matrix form:

$$(A.14) \quad \begin{bmatrix} \dot{p} \\ \dot{r} \end{bmatrix} = \begin{bmatrix} 0 & -\alpha \\ \beta & -\gamma\alpha \end{bmatrix} \begin{bmatrix} p \\ r \end{bmatrix} + \begin{bmatrix} \alpha\bar{r} \\ -\beta p_T + \gamma\alpha\bar{r} \end{bmatrix}$$

The determinant of the coefficient matrix is positive and the trace is negative, yielding convergent cycles or even monotonic paths to equilibrium.

**References**

Black, Robert P. (1990). "In Support of Price Stability." Federal Reserve Bank of Richmond Economic Review. (January/February) 76(1).

Chiang, Alpha C. (1984) Fundamental Methods of Mathematical Economics, Third Edition. New York: McGraw-Hill.

Fuhrer, Jeff and George Moore (1989). "The Stability of Wicksell's Monetary Policy Rule." (November) Paper #96, Finance and Economics Discussion Series. Division of Research and Statistics, Division of Monetary Affairs. Washington, DC: Federal Reserve Board.

Wicksell, Knut (1907). "The Influence of the Rate of Interest on Prices." Economic Journal, 17:213-20. As reprinted in Economic Thought: A Historical Anthology. Edited by J. Gherity. New York: Random House, 1965, pp. 547-54.

---

(1898). Interest and Prices. Translated by R.F. Kahn. London: Macmillan, 1936. Reprinted by A.M. Kelley, New York, 1965.